

User's Manual

Fanless Computing Solution



Power Efficient Fanless Computers
DE-1000(L/P)



Power Efficient Fanless Computers
DE-1001(L/P)



Power Efficient Fanless Computers
DE-1002(L/P)

Contents

Prefaces

Revision	05
Copyright Notice	05
Acknowledgement	05
Disclaimer	05
Declaration of Conformity	05
Product Warranty Statement	06
Technical Support and Assistance	07
Conventions Used in this Manual	07
Safety Precaution	08
Package Contents	09
Ordering Information	10
Optional Accessories	11

Chapter 1 Product Introductions

1.1 Overview	13
1.1.1 Key Feature	14
1.2 Hardware Specification	14
1.3 System I/O	16
1.3.1 DE-1000	16
1.3.2 DE-1000L/DE-1000P	18
1.3.3 DE-1001	20
1.3.4 DE-1001L/DE-1001P	22
1.3.5 DE-1002	24
1.3.6 DE-1002L/DE-1002P	26
1.4 Mechanical Dimension	28
1.4.1 DE-1000	28
1.4.2 DE-1000L/DE-1000P	29
1.4.3 DE-1001	30
1.4.4 DE-1001L/DE-1001P	31
1.4.5 DE-1002	32
1.4.6 DE-1002L/DE-1002P	33

Chapter 2 Jumpers and Connectors

2.1 Jumper Settings	35
2.2 Locations of the Jumper and Connector	35
2.2.1 Top View	35
2.2.2 Bottom View	36
2.3 Connector / Jumper / Switch Definition	37
2.4 Switch Definition	38
2.5 Jumper Definition	40
2.6 Connector Definition	41

Chapter 3 System Setup

3.1 Removing the Chassis Bottom Cover	54
3.2 Removing the Chassis	55
3.3 Installing a Half Size Mini PCIe Card on Upper Side	56
3.4 Installing a Full Size Mini PCIe Card on Upper Side	59
3.5 Installing Antenna	61

3.6	Installing a SATA Hard Drive on Upper Side	63
3.7	Installing a SATA Hard Drive on Bottom Side	65
3.8	Installing SO-DIMM 1	66
3.9	Installing SO-DIMM 2	68
3.10	Installing a Half Size Mini PCIe Card on Bottom Side	70
3.11	Installing a Full Size Mini PCIe Card on Bottom Side	73
3.12	Installing the PCI/PCIe Cards on Expansion Module	76
3.13	Installing the Chassis	79
3.14	Installing the Chassis Bottom Cover	80
3.15	Installing a SIM Card	81
3.16	Installing a CFAST Card	82
3.17	Wall Mount Bracket	83

Chapter 4 BIOS Setup

4.1	BIOS Introduction	86
4.2	Main Setup	87
4.2.1	System Date	87
4.2.2	System Time	87
4.3	Advanced Setup	88
4.3.1	ACPI Settings	88
4.3.2	Super IO Configuration	89
4.3.3	Hardware Monitor	93
4.3.4	Serial Port Console Redirection	93
4.3.5	CPU Configuration	94
4.3.6	PPM Configuration	95
4.3.7	Thermal Configuration	96
4.3.8	IDE Configuration	97
4.3.9	OS Selection	98
4.3.10	CSM (Compatibility Support Module) Configuration	99
4.3.11	USB Configuration	100
4.4	Chipset	101
4.4.1	North Bridge	101
4.4.2	South Bridge	103
4.5	Security	105
4.5.1	Administrators Password	105
4.5.2	Users Password	105
4.6	Boot	106
4.6.1	Setup Prompt Timeout	106
4.6.2	Bootup NumLock State	106
4.6.3	Full Screen Logo Show	106
4.6.4	Fast Boot	106
4.7	Save & Exit	107
4.7.1	Save Changes and Reset	107
4.7.2	Discard Changes and Reset	107
4.7.3	Restore Defaults	107
4.7.4	Save as User Defaults	107
4.7.5	Restore User Defaults	107

Chapter 5 Product Application

- 5.1 Digital I/O (DIO) application..... 109
 - 5.1.1 Digital I/O Programming Guide..... 109
- 5.2 Digital I/O (DIO) Hardware Specification..... 114

Prefaces

Revision

Revision	Description	Date
1.0	Manual Released	2015/01/12
1.1	DIO PIN Define Revision	2015/05/08
1.2	Content corrected, product pictures updated, CH. 5 added	2016/06/20
1.3	Add 1.2 support dimension of add-on card	2017/06/21
1.40	Correction Made	2018/11/20

Copyright Notice

© 2014 by Cincoze Co., Ltd. All rights are reserved. No parts of this manual may be copied, modified, or reproduced in any form or by any means for commercial use without the prior written permission of Cincoze Co., Ltd. All information and specification provided in this manual are for reference only and remain subject to change without prior notice.

Acknowledgement

Cincoze is a registered trademark of Cincoze Co., Ltd. All registered trademarks and product names mentioned herein are used for identification purposes only and may be trademarks and/or registered trademarks of their respective owners.

Disclaimer

This manual is intended to be used as a practical and informative guide only and is subject to change without notice. It does not represent a commitment on the part of Cincoze. This product might include unintentional technical or typographical errors. Changes are periodically made to the information herein to correct such errors, and these changes are incorporated into new editions of the publication.

Declaration of Conformity



FCC

This equipment has been tested and found to comply with the limits for a Class A digital device, pursuant to Part 15 of the FCC Rules. These limits are designed to provide reasonable protection against harmful interference when the equipment is operated in a commercial environment. This equipment generates, uses, and can radiate radio frequency energy and, if not installed and used in accordance with the instruction manual, may cause harmful interference to radio communications. Operation of this equipment in a residential area is likely to cause harmful interference in which case the user will be required to correct the interference at his own expense.



CE

The product(s) described in this manual complies with all application European Union (CE) directives if it has a CE marking. For computer systems to remain CE compliant, only CE-compliant parts may be used. Maintaining CE compliance also requires proper cable and cabling techniques.

Product Warranty Statement

Warranty

Cincoze products are warranted by Cincoze Co., Ltd. to be free from defect in materials and workmanship for 2 years from the date of purchase by the original purchaser.

During the warranty period, we shall, at our option, either repair or replace any product that proves to be defective under normal operation.

Defects, malfunctions, or failures of the warranted product caused by damage resulting from natural disasters (such as by lightening, flood, earthquake, etc.), environmental and atmospheric disturbances, other external forces such as power line disturbances, plugging the board in under power, or incorrect cabling, and damage caused by misuse, abuse, and unauthorized alteration or repair, and the product in question is either software, or an expendable item (such as a fuse, battery, etc.), are not warranted.

RMA

Before sending your product in, you will need to fill in Cincoze RMA Request Form and obtain a RMA number from us. Our staff is available at any time to provide you with the most friendly and immediate service.

■ RMA Instruction

- Customers must fill in Cincoze Return Merchandise Authorization (RMA) Request Form and obtain a RMA number prior to returning a defective product to Cincoze for service.
- Customers must collect all the information about the problems encountered and note anything abnormal and describe the problems on the "Cincoze Service Form" for the RMA number apply process.
- Charges may be incurred for certain repairs. Cincoze will charge for repairs to products whose warranty period has expired. Cincoze will also charge for repairs to products if the damage resulted from acts of God, environmental or atmospheric disturbances, or other external forces through misuse, abuse, or unauthorized alteration or repair. If charges will be incurred for a repair, Cincoze lists all charges, and will wait for customer's approval before performing the repair.
- Customers agree to insure the product or assume the risk of loss or damage during transit, to prepay shipping charges, and to use the original shipping container or equivalent.
- Customers can be send back the faulty products with or without accessories (manuals, cable, etc.) and any components from the system. If the components were suspected as part of the problems, please note clearly which components are included. Otherwise, Cincoze is not responsible for the devices/parts.
- Repaired items will be shipped along with a "Repair Report" detailing the findings and actions taken.

Limitation of Liability

Cincoze' liability arising out of the manufacture, sale, or supplying of the product and its use, whether based on warranty, contract, negligence, product liability, or otherwise, shall not exceed the original selling price of the product. The remedies provided herein are the customer's sole and exclusive remedies. In no event shall Cincoze be liable for direct, indirect, special or consequential damages whether based on contract of any other legal theory.

Technical Support and Assistance

1. Visit the Cincoze website at <http://www.cincoze.com/en/warranty.php> where you can find the latest information about the product.
2. Contact your distributor or our technical support team or sales representative for technical support if you need additional assistance. Please have following information ready before you call:
 - Product name and serial number
 - Description of your peripheral attachments
 - Description of your software (operating system, version, application software, etc.)
 - A complete description of the problem
 - The exact wording of any error messages

Conventions Used in this Manual



WARNING

This indication alerts operators to an operation that, if not strictly observed, may result in severe injury.



CAUTION

This indication alerts operators to an operation that, if not strictly observed, may result in safety hazards to personnel or damage to equipment.



NOTE

This indication provides additional information to complete a task easily.

Safety Precautions

Before installing and using this device, please note the following precautions:

1. Read these safety instructions carefully.
2. Keep this User's Manual for future reference.
3. Disconnect this equipment from any AC outlet before cleaning.
4. For plug-in equipment, the power outlet socket must be located near the equipment and must be easily accessible.
5. Keep this equipment away from humidity.
6. Put this equipment on a reliable surface during installation. Dropping it or letting it fall may cause damage.
7. Make sure the voltage of the power source is correct before connecting the equipment to the power outlet.
8. Use a power cord that has been approved for using with the product and that it matches the voltage and current marked on the product's electrical range label. The voltage and current rating of the cord must be greater than the voltage and current rating marked on the product.
9. Position the power cord so that people cannot step on it. Do not place anything over the power cord.
10. All cautions and warnings on the equipment should be noted.
11. If the equipment is not used for a long time, disconnect it from the power source to avoid damage by transient overvoltage.
12. Never pour any liquid into an opening. This may cause fire or electrical shock.
13. Never open the equipment. For safety reasons, the equipment should be opened only by qualified service personnel.

If one of the following situations arises, get the equipment checked by service personnel:
 - The power cord or plug is damaged.
 - Liquid has penetrated into the equipment.
 - The equipment has been exposed to moisture.
 - The equipment does not work well, or you cannot get it to work according to the user's manual.
 - The equipment has been dropped and damaged.
 - The equipment has obvious signs of breakage.
14. CAUTION: Danger of explosion if battery is incorrectly replaced. Replace only with the same or equivalent type recommended by the manufacturer.

Package Contents

Before installation, please ensure all the items listed in the following table are included in the package.

Item	Description	Q'ty
1	DE-1000 (L/P) / DE-1001 (L/P) / DE-1002 (L/P) Embedded System	1
2	Utility DVD Driver	1
3	DIO Terminal Block Connector	2
4	Power Terminal Block Connector	1
5	Remote Power Terminal Block Connector	2
6	DVI-I to VGA Adapter	1
7	Screw Pack	1
8	Wall Mount Kit	1

Note: *Notify your sales representative if any of the above items are missing or damaged.*

Ordering Information

Model No.	Product Description
DE-1000	Intel Atom E3845 Quad Core Power Efficient Fanless Computer
DE-1000L	Intel Atom E3845 Quad Core Power Efficient Fanless Computer with 6x LANs
DE-1000P	Intel Atom E3845 Quad Core Power Efficient Fanless Computer with 4x PoE, 2x LANs
DE-1001-E	Intel Atom E3845 Quad Core Power Efficient Fanless Computer with 1x PCIe1 Expansion
DE-1001-P	Intel Atom E3845 Quad Core Power Efficient Fanless Computer with 1x PCI Expansion
DE-1001L-E	Intel Atom E3845 Quad Core Power Efficient Fanless Computer with 1x PCIe1 Expansion, 6x LANs
DE-1001L-P	Intel Atom E3845 Quad Core Power Efficient Fanless Computer with 1x PCI Expansion, 6x LANs
DE-1001P-E	Intel Atom E3845 Quad Core Power Efficient Fanless Computer with 1x PCIe1 Expansion, 4x PoE, 2x LANs
DE-1001P-P	Intel Atom E3845 Quad Core Power Efficient Fanless Computer with 1x PCI Expansion, 4x PoE, 2x LANs
DE-1002-EE	Intel Atom E3845 Quad Core Power Efficient Fanless Computer with 2x PCIe1 Expansions
DE-1002-PP	Intel Atom E3845 Quad Core Power Efficient Fanless Computer with 2x PCI Expansions
DE-1002L-EE	Intel Atom E3845 Quad Core Power Efficient Fanless Computer with 2x PCIe1 Expansions, 6x LANs
DE-1002L-PP	Intel Atom E3845 Quad Core Power Efficient Fanless Computer with 2x PCI Expansions, 6x LANs
DE-1002P-EE	Intel Atom E3845 Quad Core Power Efficient Fanless Computer with 2x PCIe1 Expansions, 4x PoE, 2x LANs
DE-1002P-PP	Intel Atom E3845 Quad Core Power Efficient Fanless Computer with 2x PCI Expansions, 4x PoE, 2x LANs

Optional Accessories

Model Name	Description
GSM60A12-CIN	Adapter AC/DC 12V 5A 60W with 3pin Terminal Block Plug 5.0mm Pitch, GS60MA12-P1J
GS120A24-CIN	Adapter AC/DC 24V 5A 120W with 3pin Terminal Block Plug 5.0mm Pitch, GS120A24-P1M
SL2-SL3	US 2 heads power cord, US B type to IEC C13, SVT 18AWG/3C Black 1.8M SL-2+SL-3
SL6-SL3	EU 2 heads power cord, EU G type to IEC C13, H05VV-F 0.75mm ² /3G Black 1.8M SL-6+SL-3
QP026-SL3	UK 2 heads power cord, UK I type to IEC C13, H05VV-F 0.75mm ² /3G Black 1.8M QP026+SL-3
VESA-DE	DE series VESA Mount Kit
SIDE-DE	DE series SIDE Mount Kit
DINRAIL	Diamond series DIN-RAIL Mount Kit
59381560000E	MINI-DIN(M) (PS/2 KB+MS) TO MINI-DIN(F) (PS/2 KB)+MINI-DIN(F) (PS/2 MS) L:10CM, 59381560000E
N0307-140507-01	DVI-I(M) TO DVI-D(F) + VGA(F) Cable, L=200mm, N0307-140507-01



Chapter 1

Product Introductions

1.1 Overview

DE-1000 Series Fanless Embedded PC supports Intel® Bay Trail platform, integrated with Intel® Atom™ E3845 Quad Core 1.91 GHz processor. Delivering the excellent quad-core processing power at only 10 watts power consumption, DE-1000 series is definitely an ideal solution for ultimate computing performance, energy efficiency, and superior reliability.

Designed with rich I/O, high flexibility and easy expansion capabilities, DE-1000 series is ideal for diverse industrial applications. It offers multiple I/O extension modules, including up to 2x PCI or 2x PCIe x1 slot for flexible integration of a variety of add-on cards; 2x mini-PCIe slot for GSM and WLAN wireless communication; it also supports three storage expansions: 2.5" SATA HDD, CFast and SIM card.

Supporting up to 6x LAN or 4x PoE versions, and power ignition function, DE-1000 series can meet various applications, such as: surveillance, in-vehicle, and industrial automation applications, etc.

DE-1000 series supports wide temperature range from -25°C to +70°C, wide range 9~48VDC power input, power protection, cable-less and one-piece housing design, as well as compliant with EN50155 certification for rail transportation applications; it is designed to ensure stable operation in robust and harsh environments.

DE-1000



Front

DE-1001



Front

DE-1002



Front



Rear



Rear



Rear

**DE-1000L
DE-1000P**



Front

**DE-1001L
DE-1001P**



Front

**DE-1002L
DE-1002P**



Front



Rear



Rear



Rear

1.1.1 Key Features

- Onboard Intel® Atom™ E3845 Processor Quad Core, 1.91GHz
- 2x DDR3L SO-DIMM Max. up to 8GB
- Dual Independent Display from 1x DVI-I and 1x DisplayPort
- 2x Intel® GbE Port, Support Wake-on-LAN and PXE (DE-1000, DE-1001, DE-1002 Only)
- 6x Intel® GbE Port, Support Wake-on-LAN and PXE (DE-1000L, DE-1001L, DE-1002L Only)
- 6x Intel® GbE Port with 4x PoE Function, Support Wake-on-LAN, 2x Support PXE (DE-1000P, DE-1001P, DE-1002P Only)
- 1x USB 3.0, 4x USB 2.0
- 6x RS232/422/485 Port with 5V/12V Power
- 4x Isolated DI, 4x Isolated DO
- 2x 2.5" SATA SSD/HDD Bay, 1x mSATA (Shared by Mini-PCIe Socket) , 1x CFast Card and 1x SIM Card Socket
- 9~48VDC Power Input, support AT/ATX Mode
- 2x Mini-PCIe Slot for Wi-Fi, GSM, or I/O Expansion
- 1x PCI or 1x PCIe x1 Expansion (DE-1001, DE-1001L, DE-1001P Only)
- 2x PCI or 2x PCIe x1 Expansion (DE-1002, DE-1002L, DE-1002P Only)
- Power Ignition
- Compliant with EN50155 for Rail Transportation Applications

1.2 Hardware Specification

Processor System

- Onboard Intel® Atom™ Processor E3845 Quad Core, 1.91 GHz with AMI 64Mbit SPI BIOS

Memory

- 2x 204-Pin DDR3L-1066 / 1333MHz SO-DIMM (un-buffered and non-ECC), Max. up to 8GB

Display

Dual Display

- 1x DVI and 1x DisplayPort
- 1x DVI-D and 1x VGA (w/ Optional Split Cable)
- 1x DisplayPort and 1x VGA (w/ DVI-I to VGA Adapter)

Expansion

- **DE-1001-E, DE-1001L-E, DE-1001P-E**
 - ✓ 1x PCIe x1
 - Support maximum dimension of add-on card (H x L): 111.15mm x 174.63mm
- **DE-1001-P, DE-1001L-P, DE-1001P-P**
 - ✓ 1x PCI
 - Support maximum dimension of add-on card (H x L): 111.15mm x 174.63mm
- **DE-1002-EE, DE-1002L-EE, DE-1002P-EE:**
 - ✓ 2x PCIe x1
 - Support maximum dimension of add-on card (H x L): 111.15mm x 174.63mm
- **DE-1002-PP, DE-1002L-PP, DE-1002P-PP**
 - ✓ 2x PCI
 - Support maximum dimension of add-on card (H x L): 111.15mm x 174.63mm
- 2x Full-size Mini PCIe Socket for Wi-Fi / GSM / Expansion Module
- 1x Universal I/O Bracket (DE-1001, DE-1001L, DE-1001P Only)
- 2x Universal I/O Bracket (DE-1002, DE-1002L, DE-1002P Only)

Ethernet

- DE-1000/DE-1001/DE-1002:
2x Intel® i210-AT GbE LAN Port, Support Wake-on-LAN and PXE
- DE-1000L/DE-1001L/DE-1002L:
2x Intel® i210-AT GbE LAN Port, Support Wake-on-LAN and PXE
4x Intel® 82583V GbE LAN Port, Support Wake-on-LAN
- DE-1000P/DE-1001P/DE-1002P:
2x Intel® i210-AT GbE LAN Port, Support Wake-on-LAN and PXE
4x 802.3at Compliant PoE Port, The Maximum DC Power Delivery on Each PoE is 25W@DC 56V Input

Audio

- Codec: Realtek ALC888S
- 1x Mic-in and 1x Line-out

Watchdog Timer

- Software Programmable Supports 1~255 sec. System Reset

Storage

- 2x 2.5" SATA HDD Bay
- 1x Internal mSATA Slot (Shared by Mini-PCIe Socket)
- 1x External CFast Socket
- 1x External SIM Card Socket

I/O Ports

- 1x USB 3.0 Port
- 4x USB 2.0 Port
- 8x Optical Isolated DIO (4xDI, 4xDO), 10 Pin Terminal Block Support 9~30V
- 6x DB9 for COM1~6, Support RS-232/422/485 with Auto Flow Control
- 1x PS/2 Port
- 2x Antenna Hole
- 1x Power Switch
- 1x AT/ATX Switch
- 1x Remote Power and Reset Connector

Power

- Support AT, ATX Mode
- 1x 3-pin Terminal Block Connector with Power Input 9~48VDC
- 1x Optional AC/DC 12V/5A, 60W Power Adapter
- 1x Optional AC/DC 24V/5A, 120W Power Adapter (DE-1000P, DE-1001P, DE-1002P Only)

Environment

- Operating Temperature: Ambient with Air Flow: -25°C to 70°C (with Industrial Grade Peripherals)
- Storage Temperature: -30°C to 85°C
- Relative humidity: 10%~95% (non-condensing)
- Shock: 50 Grms
(According to IEC 60068-2-27, Half Sine, 11ms Duration)
- Vibration: Random: 5 Grms
(According to IEC 60068-2-64, 5~500Hz, 1hr/axis)

Physical

- **DE-1000 (L/P)**
 - Dimension (WxDxH): 203 x 200 x 65 mm
 - Weight: 2.84 kg
- **DE-1001 (L/P)**
 - Dimension (WxDxH): 203 x 200 x 96.5 mm
 - Weight: 3.42 kg
- **DE-1002 (L/P)**
 - Dimension (WxDxH): 203 x 200 x 114.5 mm
 - Weight: 3.76 kg
- Construction: Extruded Aluminum with Heavy Duty Metal
- Mounting: Wall Mounting (Side / VESA / DIN-Rail For DE-1000(L/P) Only)

Operating System

- Windows® 10
- Windows® 8
- Windows® Embedded 8 Standard
- Windows® 7
- Windows® Embedded Standard 7
- Linux® Ubuntu 14.04

Regulations

- CE
- FCC Class A
- EN 50155
- EN 50121-3-2

1.3 System I/O

1.3.1 DE-1000

Front Panel

ATX power on/off switch

Press to power-on or power-off the system

Power LED

Indicates the power status of the system

HDD LED

Indicates the status of the hard drive

USB 2.0 port

Used to connect USB 2.0/1.1 device

AT/ATX mode select switch

Used to select AT or ATX power mode

CFast and SIM card

Used to insert a CFast card and SIM card

COM port

COM 3 ~ COM 6 support RS232/422/485 serial device

Digital I/O Terminal Block

The Digital I/O terminal block supports 4 digital input and 4 digital output

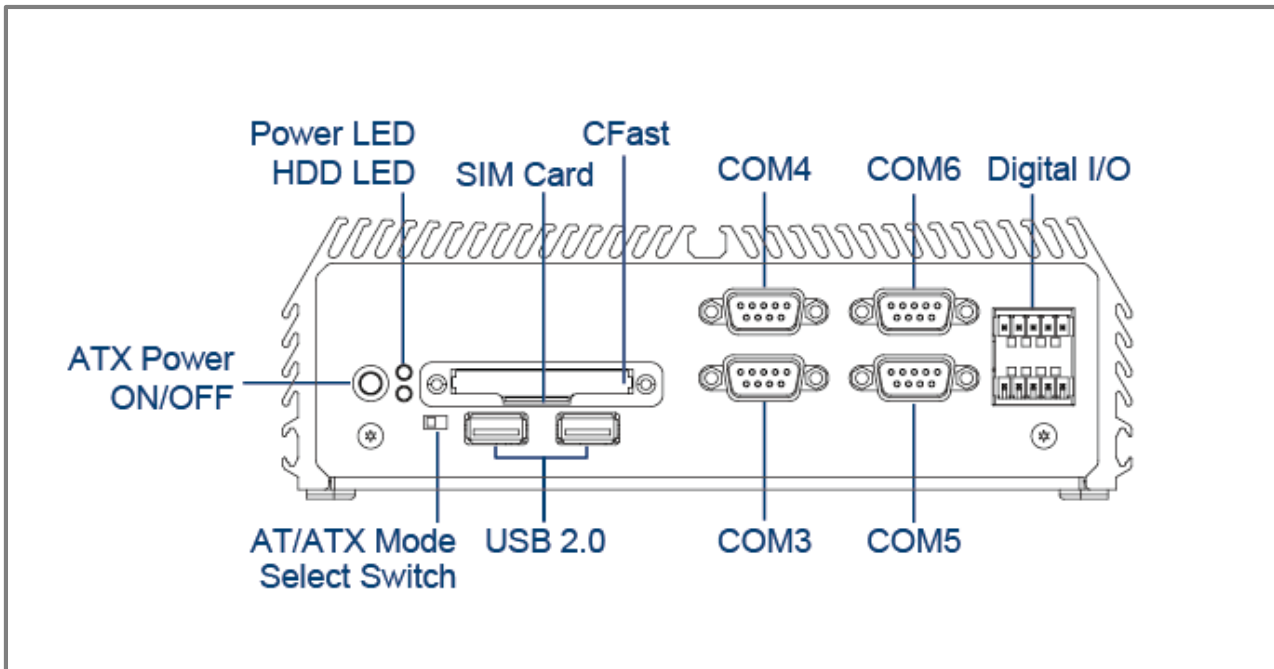

Rear Panel

DC IN

Used to plug a DC power input with terminal block

DVI-I port

Used to connect a DVI monitor or connect optional split cable for dual display mode

PS/2 Port

Used to connect the PS/2 device

LAN port (1~2)

Used to connect the system to a local area network

USB 3.0 port

Used to connect USB 3.0/2.0/1.1 device

USB 2.0 port

Used to connect USB 2.0/1.1 device

DisplayPort

Used to connect a DisplayPort monitor

Antenna hole

Used to connect an antenna for optional Mini-PCIe WiFi module

COM port

COM 1 ~ COM 2 support RS232/422/485 serial device

Mic-in

Used to connect a microphone

Line-out

Used to connect an amplifier

Remote Power on/off and Remote Power Reset Terminal Block

Used to plug a remote power on/off and remote power reset with terminal block

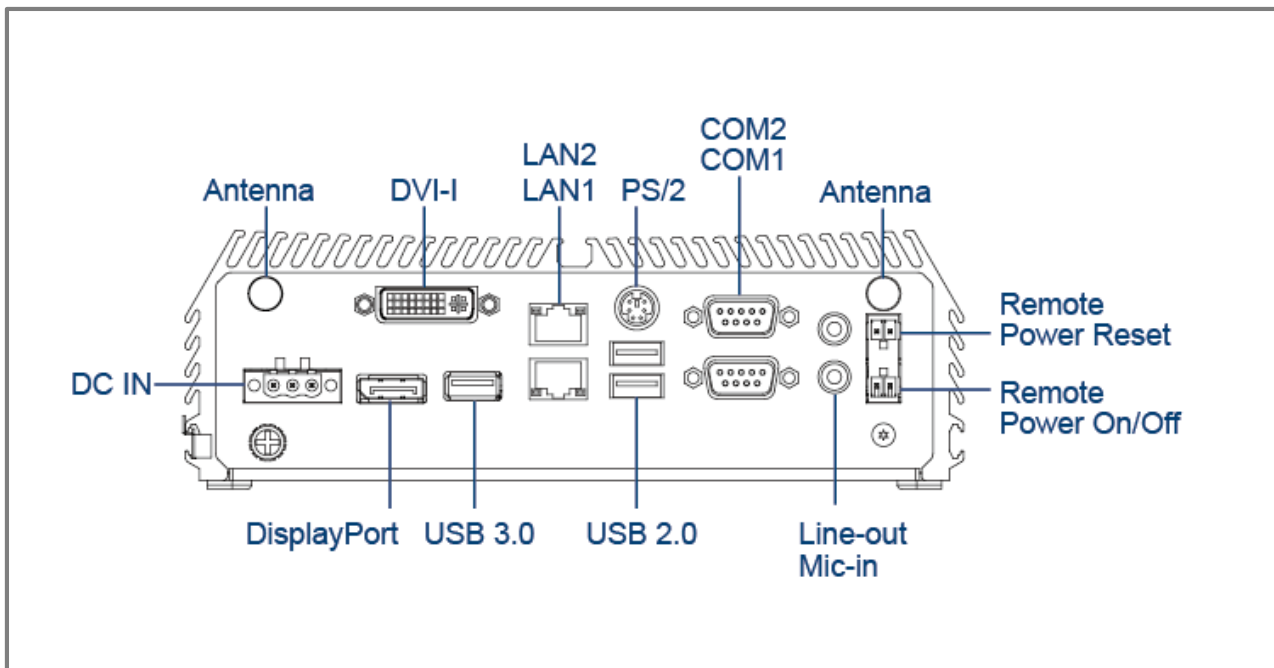

1.3.2 DE-1000L/DE-1000P

Front Panel

ATX power on/off switch

Press to power-on or power-off the system

Power LED

Indicates the power status of the system

HDD LED

Indicates the status of the hard drive

USB 2.0 port

Used to connect USB 2.0/1.1 device

LAN port (3~6)

DE-1000L: Used to connect the system to a local area network

DE-1000P: Used to connect the system to a local area network or connect the PoE devices

AT/ATX mode select switch

Used to select AT or ATX power mode

CFast and SIM card

Used to insert a CFast card and SIM card

COM port

COM 3 ~ COM 6 support RS232/422/485 serial device

Digital I/O Terminal Block

The Digital I/O terminal block supports 4 digital input and 4 digital output

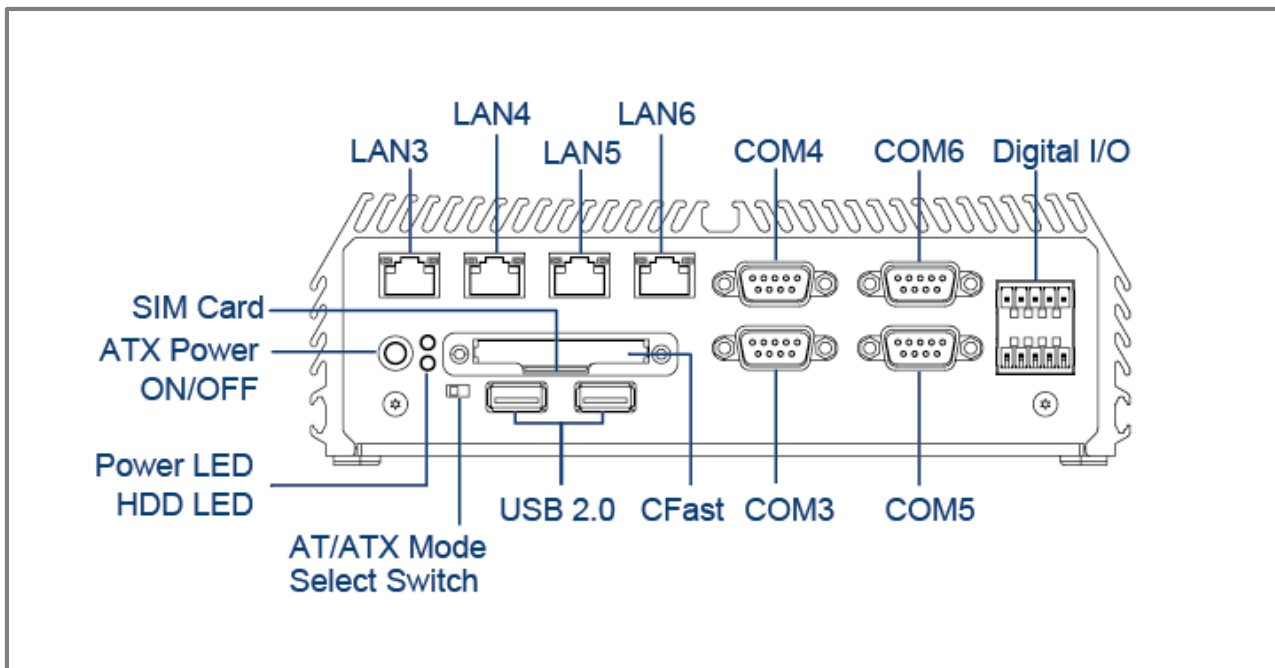

Rear Panel

DC IN

Used to plug a DC power input with terminal block

DVI-I port

Used to connect a DVI monitor or connect optional split cable for dual display mode

PS/2 Port

Used to connect the PS/2 device

LAN port (1~2)

Used to connect the system to a local area network

USB 3.0 port

Used to connect USB 3.0/2.0/1.1 device

USB 2.0 port

Used to connect USB 2.0/1.1 device

DisplayPort

Used to connect a DisplayPort monitor

Antenna hole

Used to connect an antenna for optional Mini-PCIe WiFi module

COM port

COM 1 ~ COM 2 support RS232/422/485 serial device

Mic-in

Used to connect a microphone

Line-out

Used to connect an amplifier

Remote Power on/off and Remote Power Reset Terminal Block

Used to plug a remote power on/off and remote power reset with terminal block

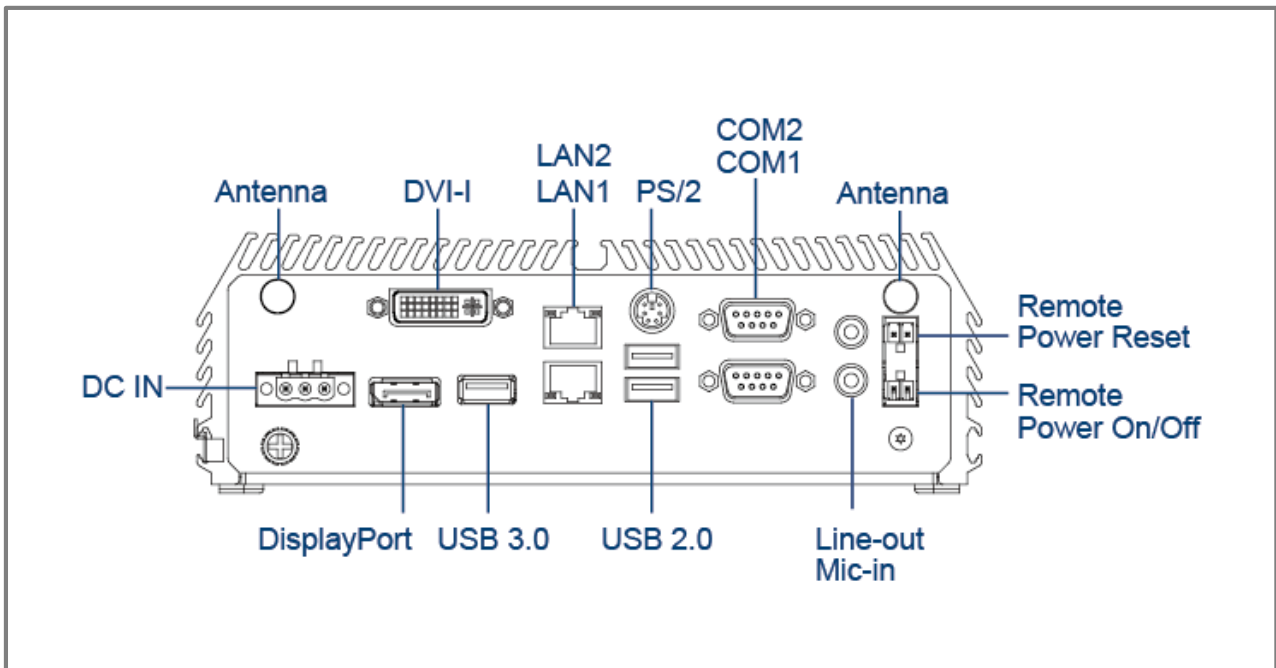

1.3.3 DE-1001

Front Panel

ATX power on/off switch

Press to power-on or power-off the system

Power LED

Indicates the power status of the system

HDD LED

Indicates the status of the hard drive

USB 2.0 port

Used to connect USB 2.0/1.1 device

AT/ATX mode select switch

Used to select AT or ATX power mode

CFast and SIM card

Used to insert a CFast card and SIM card

COM port

COM 3 ~ COM 6 support RS232/422/485 serial device

Digital I/O Terminal Block

The Digital I/O terminal block supports 4 digital input and 4 digital output

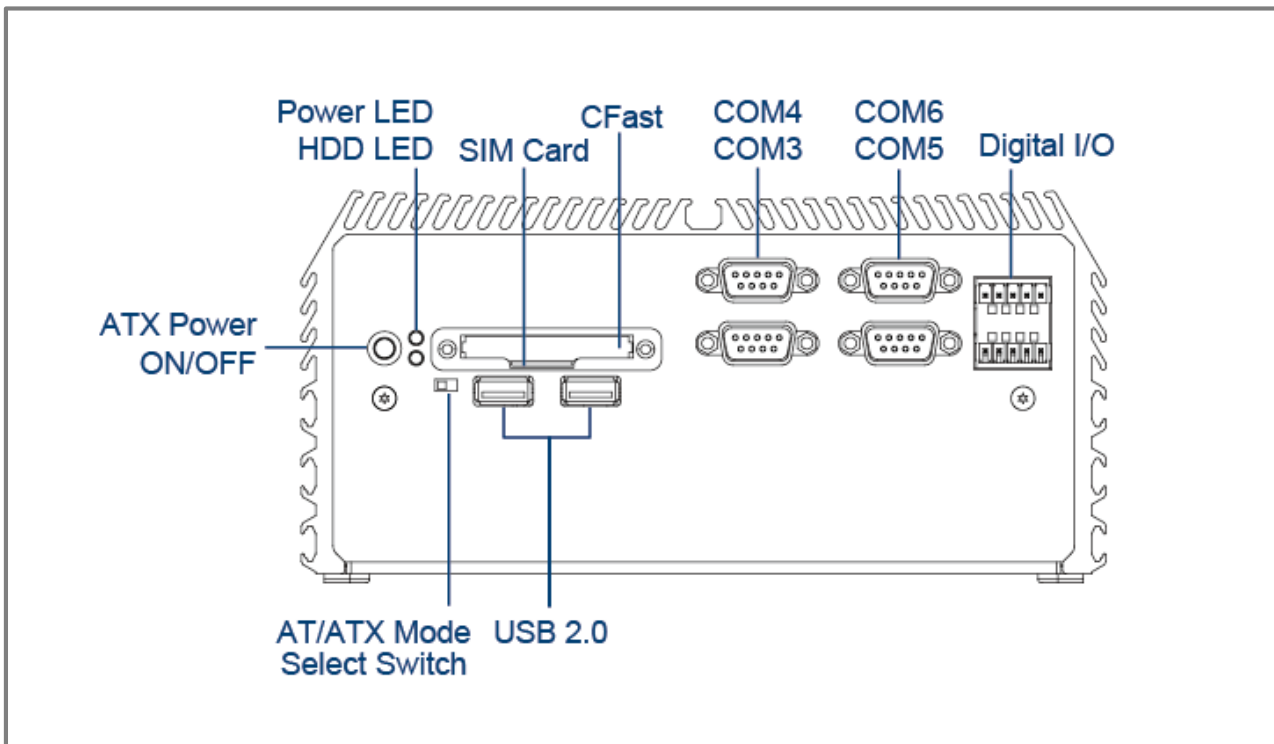

Rear Panel

DC IN

Used to plug a DC power input with terminal block

DVI-I port

Used to connect a DVI monitor or connect optional split cable for dual display mode

PS/2 Port

Used to connect the PS/2 device

LAN port (1~2)

Used to connect the system to a local area network

USB 3.0 port

Used to connect USB 3.0/2.0/1.1 device

USB 2.0 port

Used to connect USB 2.0/1.1 device

DisplayPort

Used to connect a DisplayPort monitor

Antenna hole

Used to connect an antenna for optional Mini-PCIe WiFi module

COM port

COM 1 ~ COM 2 support RS232/422/485 serial device

Mic-in

Used to connect a microphone

Line-out

Used to connect an amplifier

Remote Power on/off and Remote Power Reset Terminal Block

Used to plug a remote power on/off and remote power reset with terminal block

Universal I/O Bracket

Used to customized I/O output

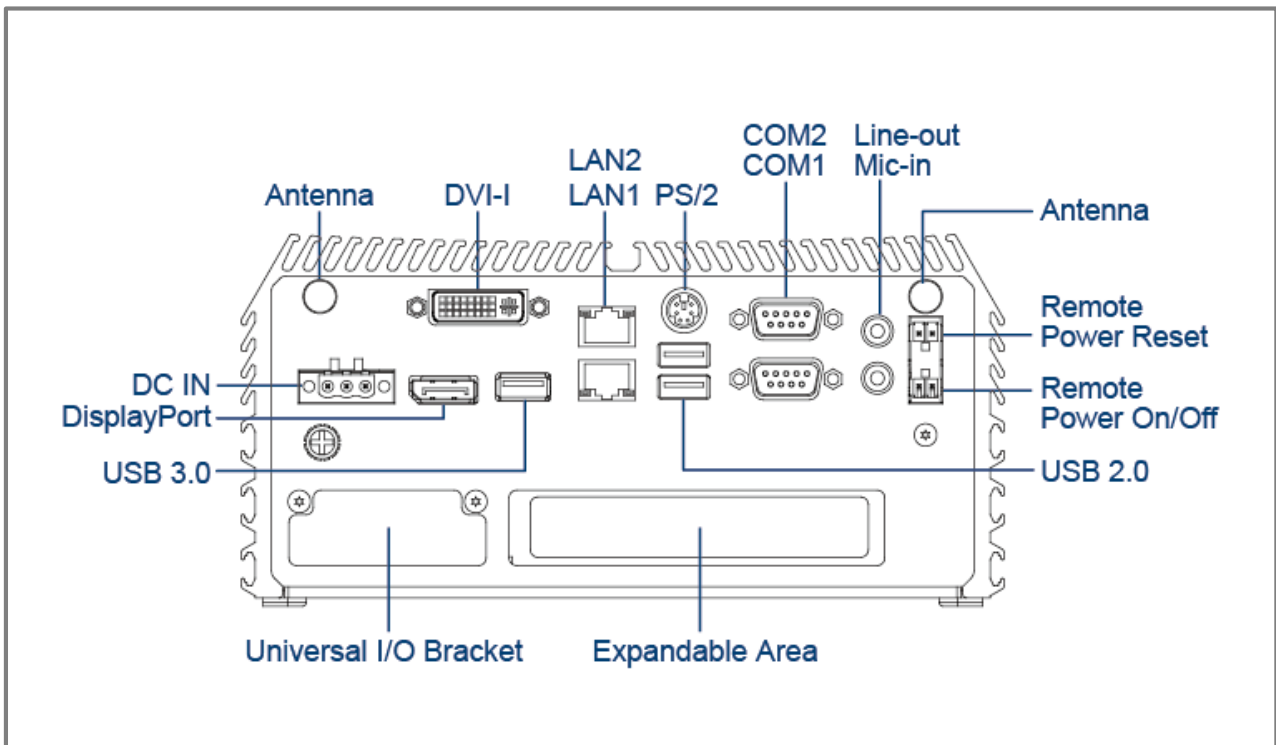

1.3.4 DE-1001L/DE-1001P

Front Panel

ATX power on/off switch

Press to power-on or power-off the system

Power LED

Indicates the power status of the system

HDD LED

Indicates the status of the hard drive

USB 2.0 port

Used to connect USB 2.0/1.1 device

LAN port (3~6)

DE-1001L: Used to connect the system to a local area network

DE-1001P: Used to connect the system to a local area network or connect the PoE devices

AT/ATX mode select switch

Used to select AT or ATX power mode

CFast and SIM card

Used to insert a CFast card and SIM card

COM port

COM 3 ~ COM 6 support RS232/422/485 serial device

Digital I/O Terminal Block

The Digital I/O terminal block supports 4 digital input and 4 digital output

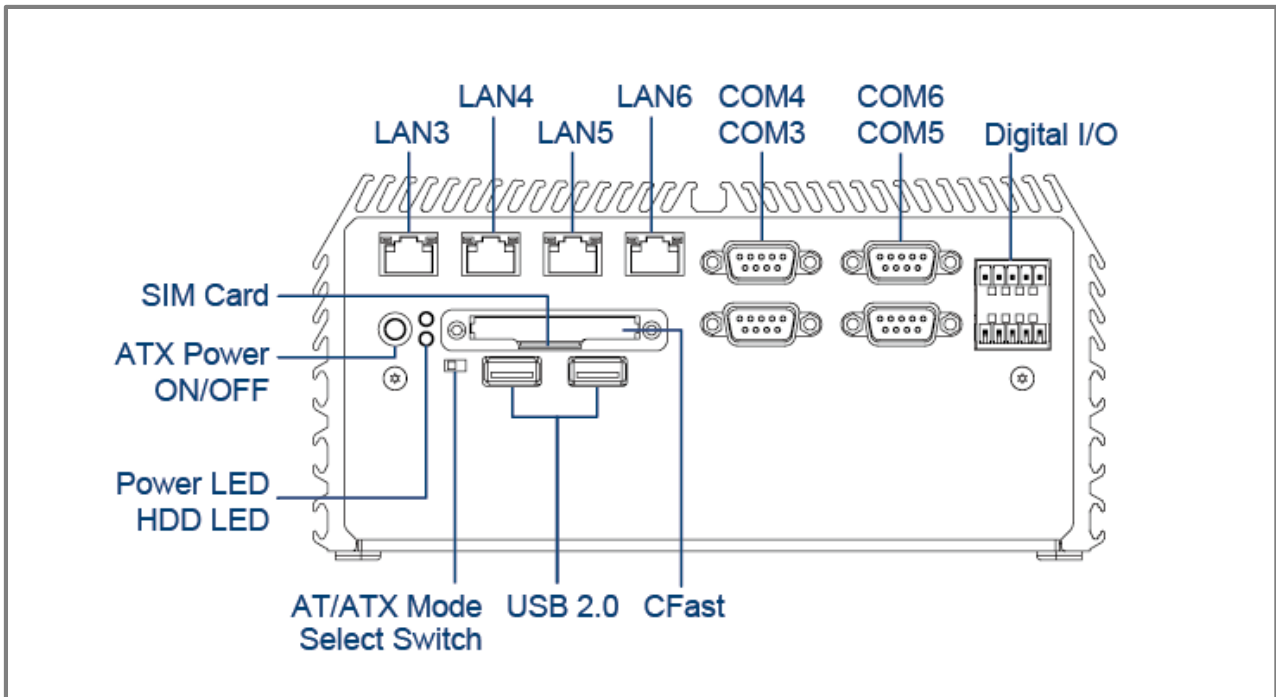

Rear Panel

DC IN

Used to plug a DC power input with terminal block

DVI-I port

Used to connect a DVI monitor or connect optional split cable for dual display mode

PS/2 Port

Used to connect the PS/2 device

LAN port (1~2)

Used to connect the system to a local area network

USB 3.0 port

Used to connect USB 3.0/2.0/1.1 device

USB 2.0 port

Used to connect USB 2.0/1.1 device

DisplayPort

Used to connect a DisplayPort monitor

Antenna hole

Used to connect an antenna for optional Mini-PCIe WiFi module

COM port

COM 1 ~ COM 2 support RS232/422/485 serial device

Mic-in

Used to connect a microphone

Line-out

Used to connect an amplifier

Remote Power on/off and Remote Power Reset Terminal Block

Used to plug a remote power on/off and remote power reset with terminal block

Universal I/O Bracket

Used to customized I/O output

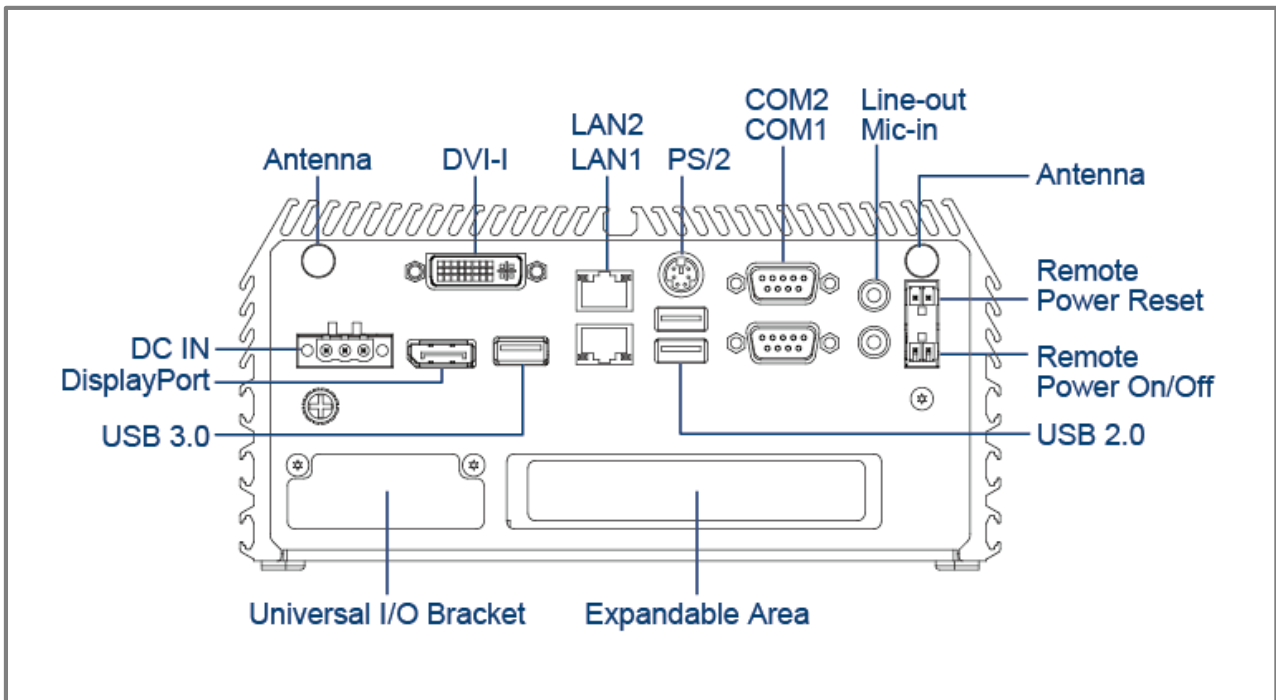

1.3.5 DE-1002

Front Panel

ATX power on/off switch

Press to power-on or power-off the system

Power LED

Indicates the power status of the system

HDD LED

Indicates the status of the hard drive

USB 2.0 port

Used to connect USB 2.0/1.1 device

AT/ATX mode select switch

Used to select AT or ATX power mode

CFast and SIM card

Used to insert a CFast card and SIM card

COM port

COM 3 ~ COM 6 support RS232/422/485 serial device

Digital I/O Terminal Block

The Digital I/O terminal block supports 4 digital input and 4 digital output

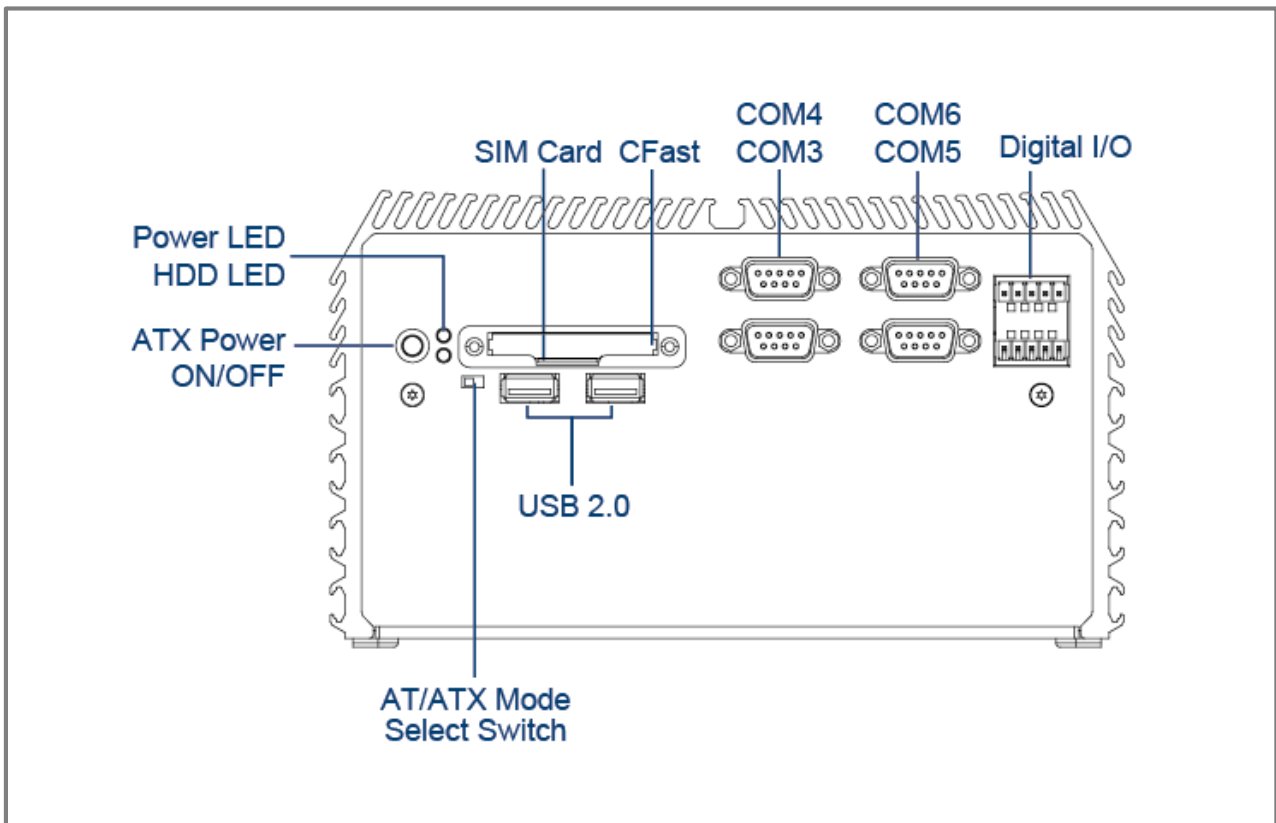

Rear Panel

DC IN

Used to plug a DC power input with terminal block

DVI-I port

Used to connect a DVI monitor or connect optional split cable for dual display mode

PS/2 Port

Used to connect the PS/2 device

LAN port (1~2)

Used to connect the system to a local area network

USB 3.0 port

Used to connect USB 3.0/2.0/1.1 device

USB 2.0 port

Used to connect USB 2.0/1.1 device

DisplayPort

Used to connect a DisplayPort monitor

Antenna hole

Used to connect an antenna for optional Mini-PCIe WiFi module

COM port

COM 1 ~ COM 2 support RS232/422/485 serial device

Mic-in

Used to connect a microphone

Line-out

Used to connect an amplifier

Remote Power on/off and Remote Power Reset Terminal Block

Used to plug a remote power on/off and remote power reset with terminal block

Universal I/O Bracket

Used to customized I/O output

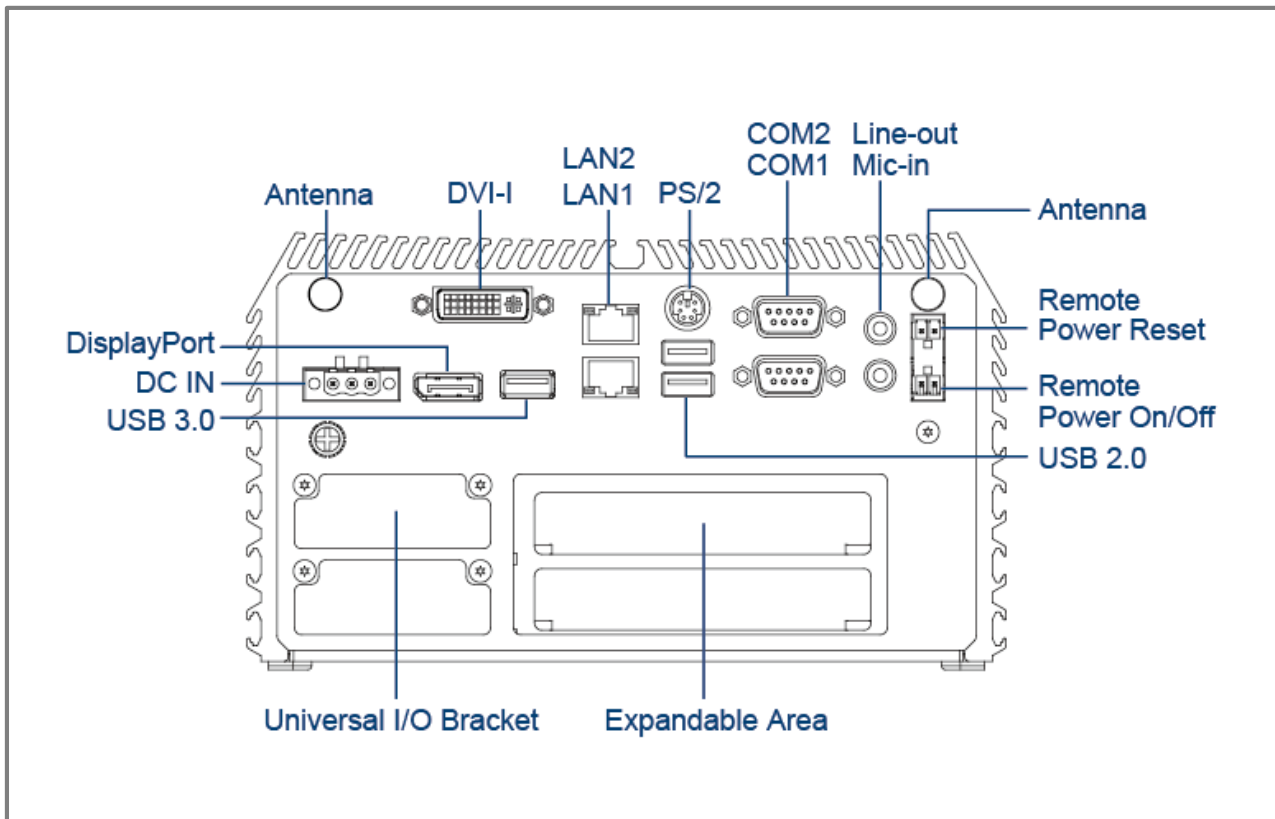

1.3.6 DE-1002L/DE-1002P

Front Panel

ATX power on/off switch

Press to power-on or power-off the system

Power LED

Indicates the power status of the system

HDD LED

Indicates the status of the hard drive

USB 2.0 port

Used to connect USB 2.0/1.1 device

LAN port (3~6)

DE-1002L: Used to connect the system to a local area network

DE-1002P: Used to connect the system to a local area network or connect the PoE devices

AT/ATX mode select switch

Used to select AT or ATX power mode

CFast and SIM card

Used to insert a CFast card and SIM card

COM port

COM 3 ~ COM 6 support RS232/422/485 serial device

Digital I/O Terminal Block

The Digital I/O terminal block supports 4 digital input and 4 digital output

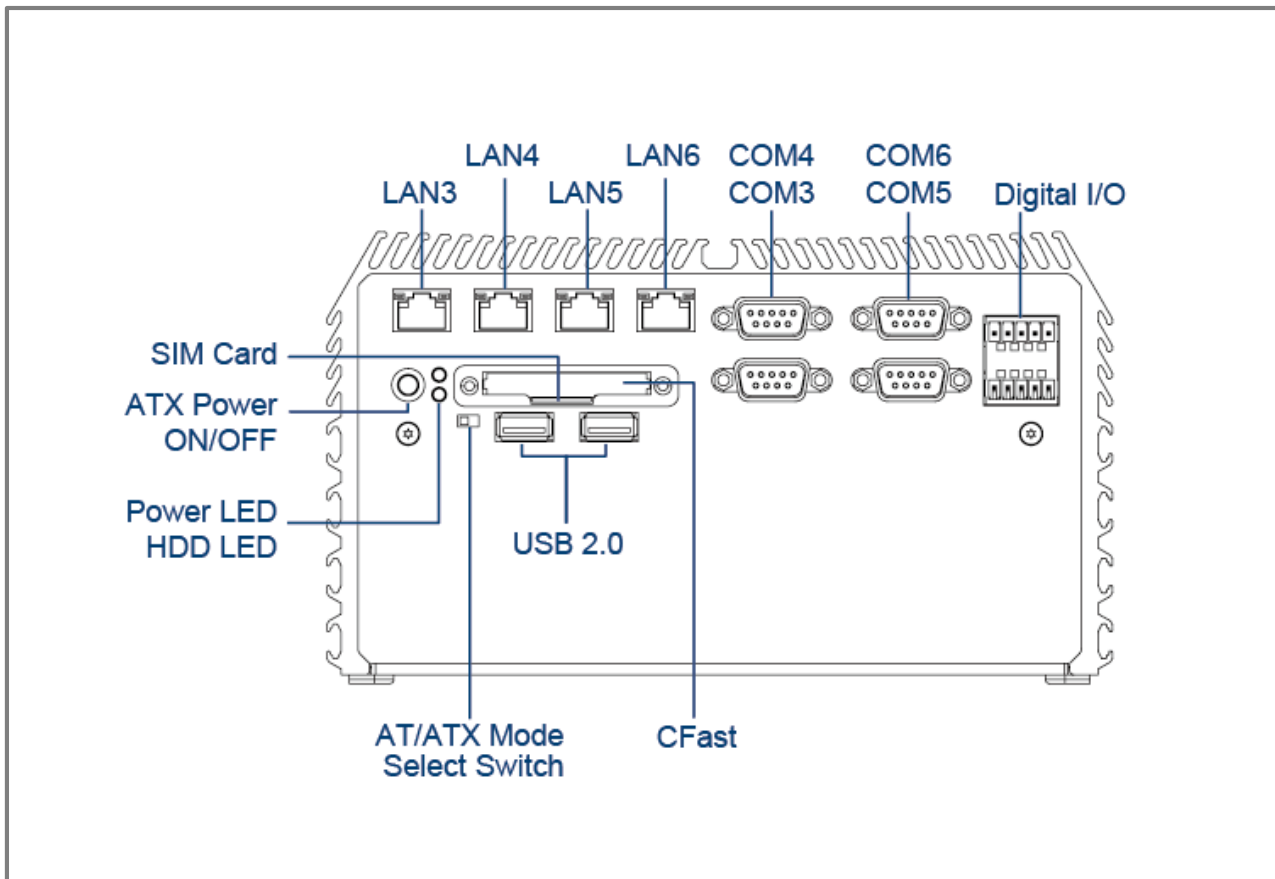

Rear Panel

DC IN

Used to plug a DC power input with terminal block

DVI-I port

Used to connect a DVI monitor or connect optional split cable for dual display mode

PS/2 Port

Used to connect the PS/2 device

LAN port (1~2)

Used to connect the system to a local area network

USB 3.0 port

Used to connect USB 3.0/2.0/1.1 device

USB 2.0 port

Used to connect USB 2.0/1.1 device

DisplayPort

Used to connect a DisplayPort monitor

Antenna hole

Used to connect an antenna for optional Mini-PCIe WiFi module

COM port

COM 1 ~ COM 2 support RS232/422/485 serial device

Mic-in

Used to connect a microphone

Line-out

Used to connect an amplifier

Remote Power on/off and Remote Power Reset Terminal Block

Used to plug a remote power on/off and remote power reset with terminal block

Universal I/O Bracket

Used to customized I/O output

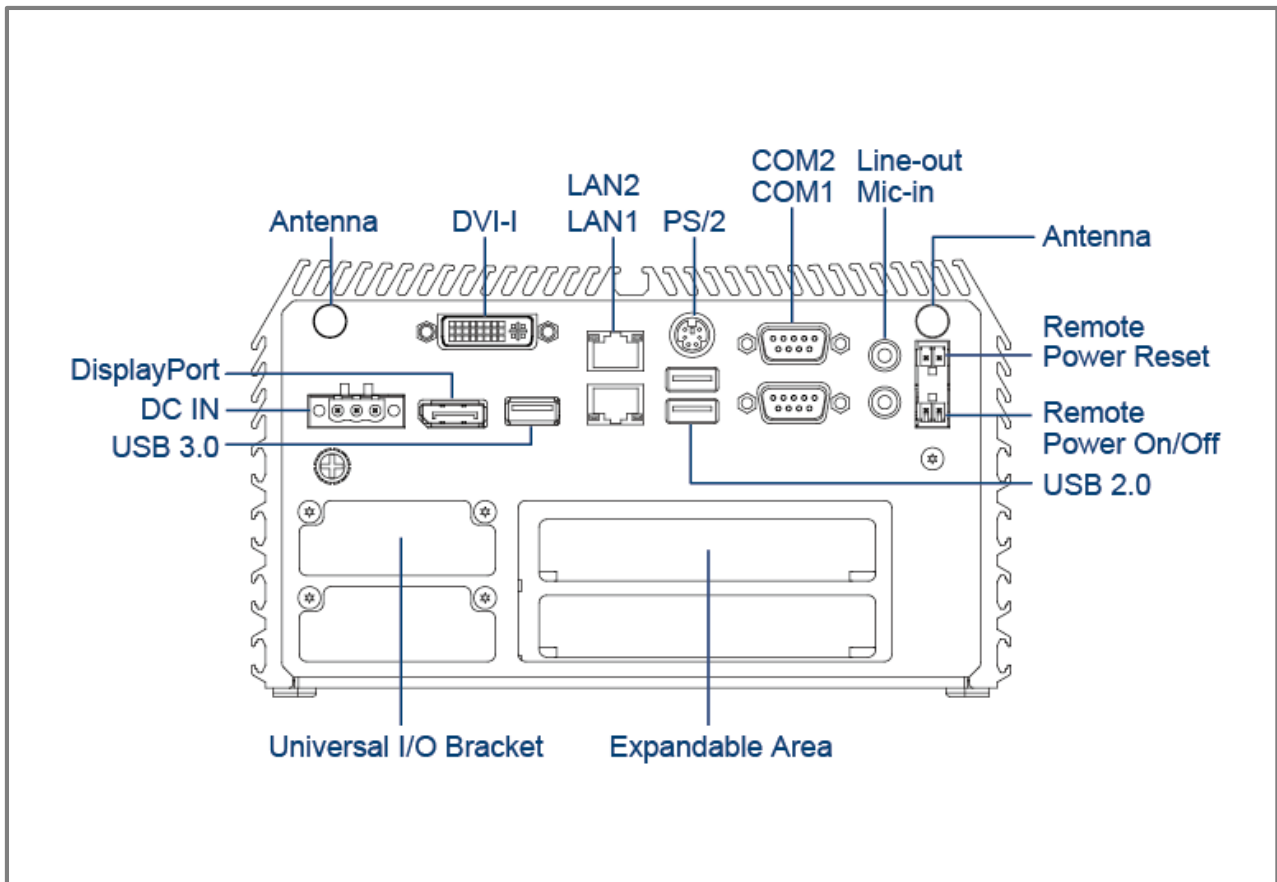

1.4 Mechanical Dimensions

1.4.1 DE-1000

Unit: mm

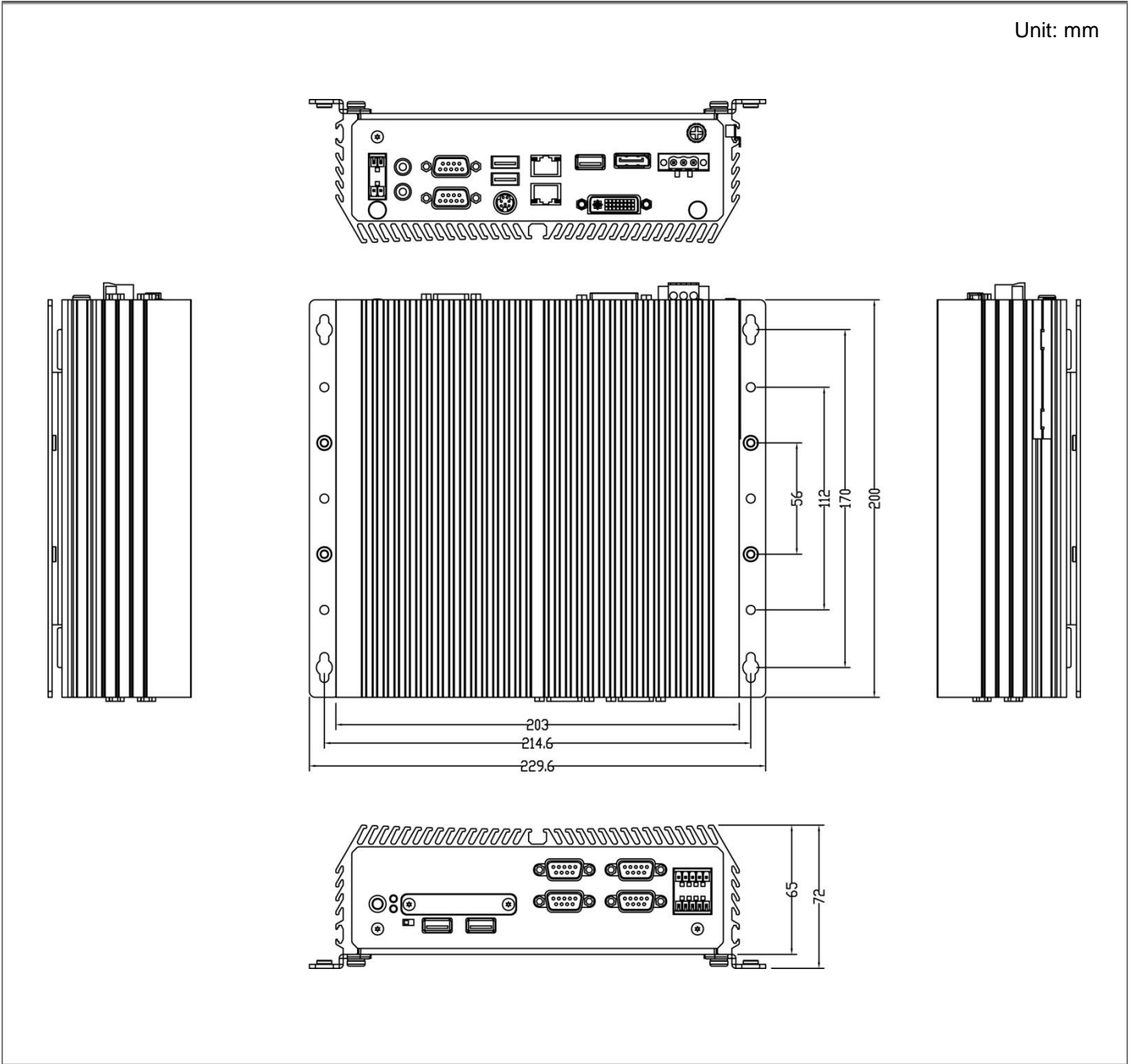

1.4.2 DE-1000L/DE-1000P

Unit: mm

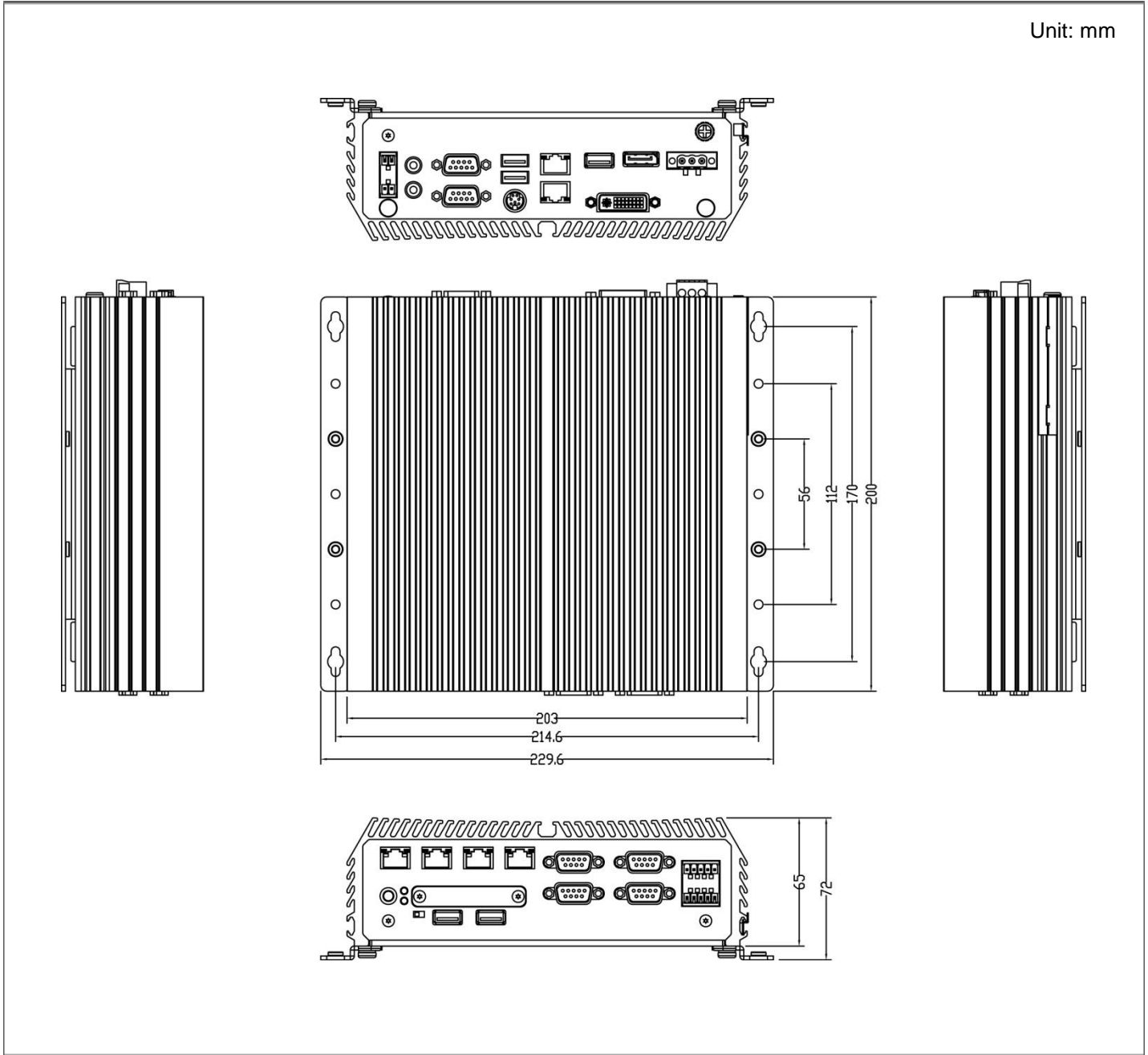

1.4.3 DE-1001

Unit: mm

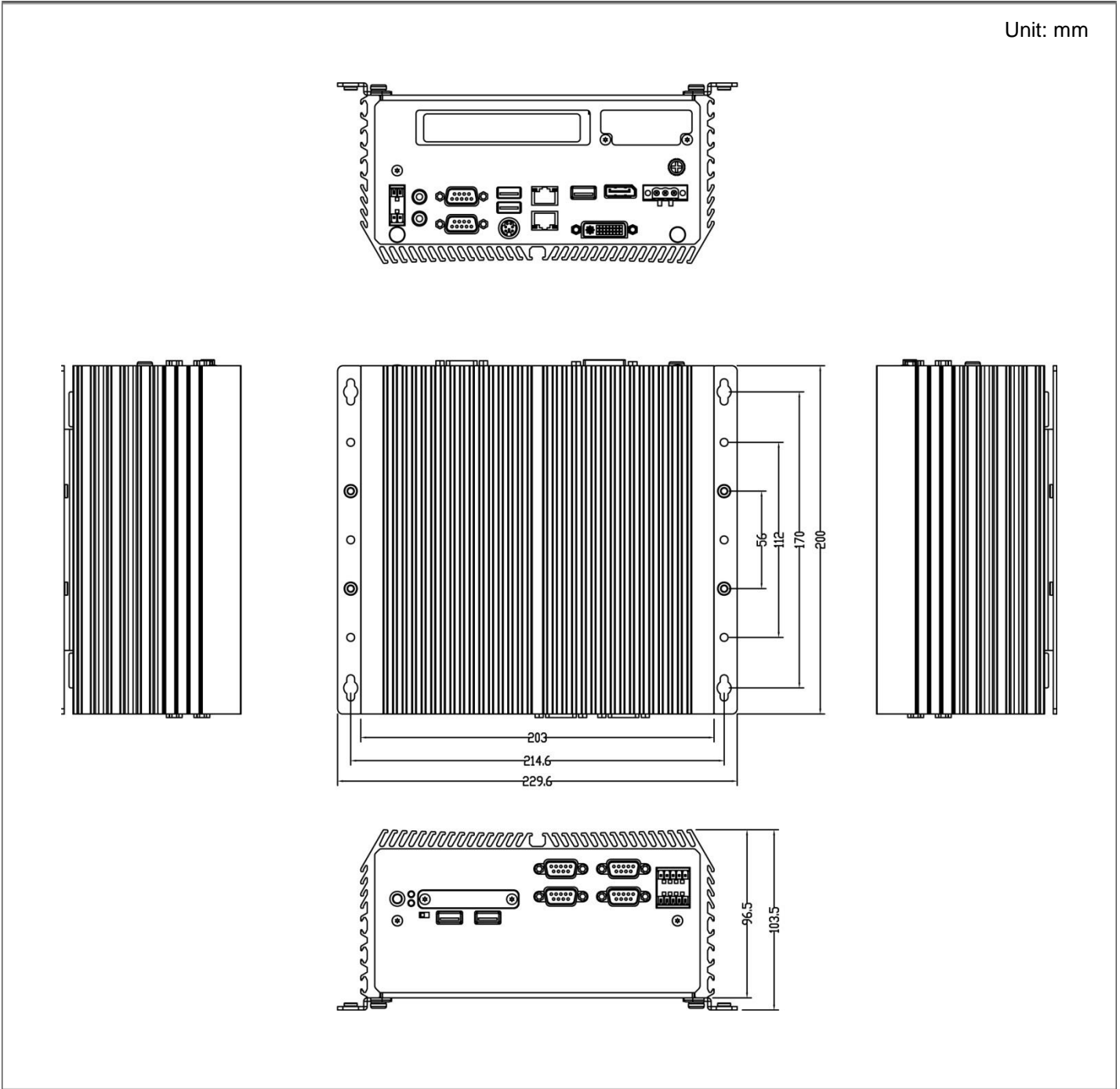

1.4.5 DE-1002

Unit: mm

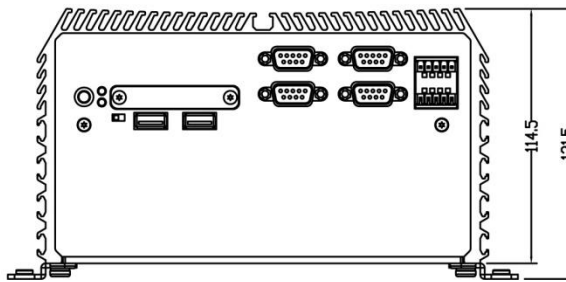
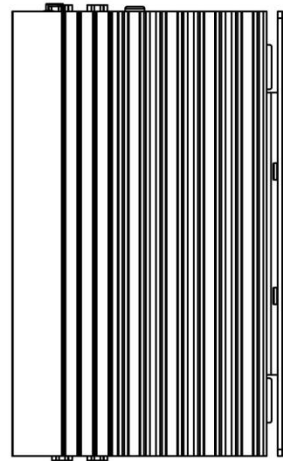
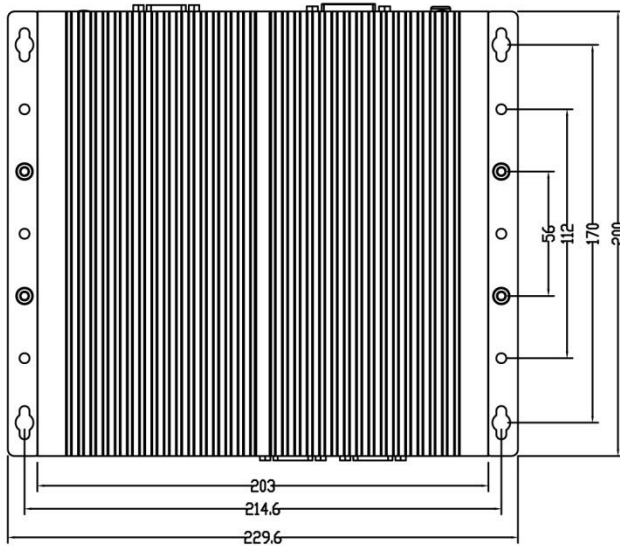
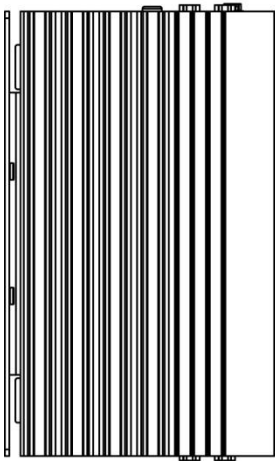
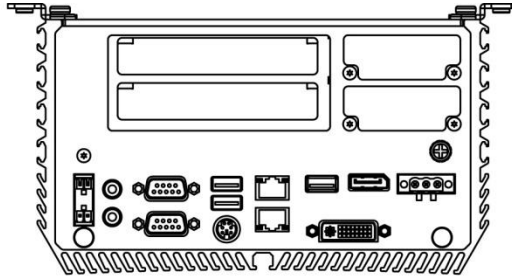

1.4.6 DE-1002L/DE-1002P

Unit: mm

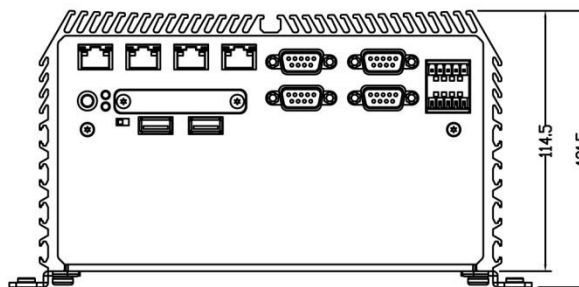
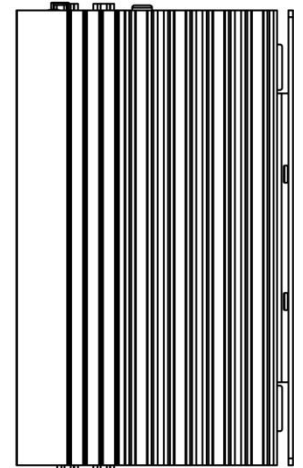
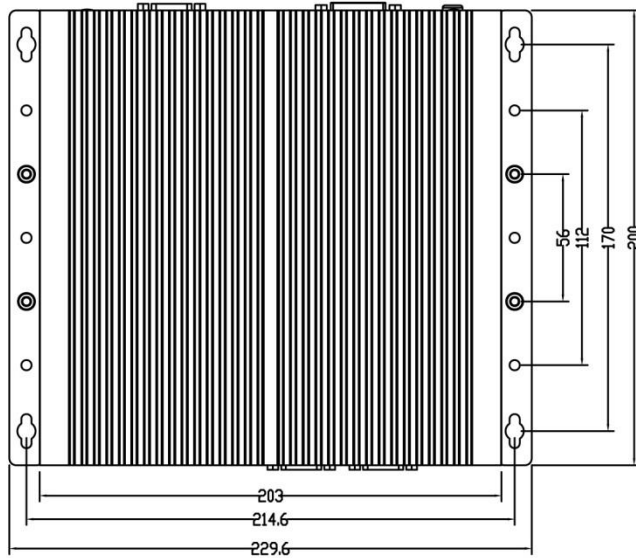
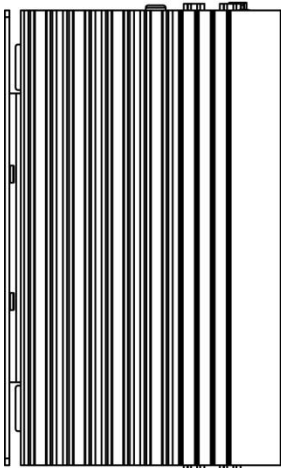
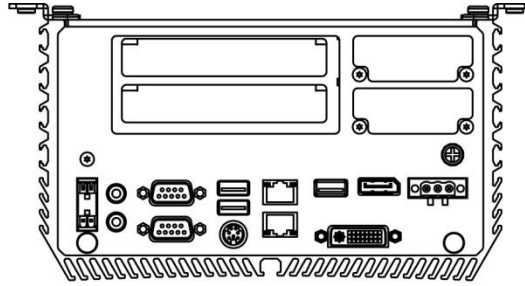



Chapter 2

Jumpers and Connectors

2.1 Jumpers Settings

When setting the jumpers, ensure that the jumper caps are placed on the correct pins. When the jumper cap is placed on both pins, the jumper is **short**. If you remove the jumper cap, or place the jumper cap on just one pin, the jumper is **open**. Refer to below for examples of the 2-pin and 3-pin jumpers when they are short (on) and open (off).

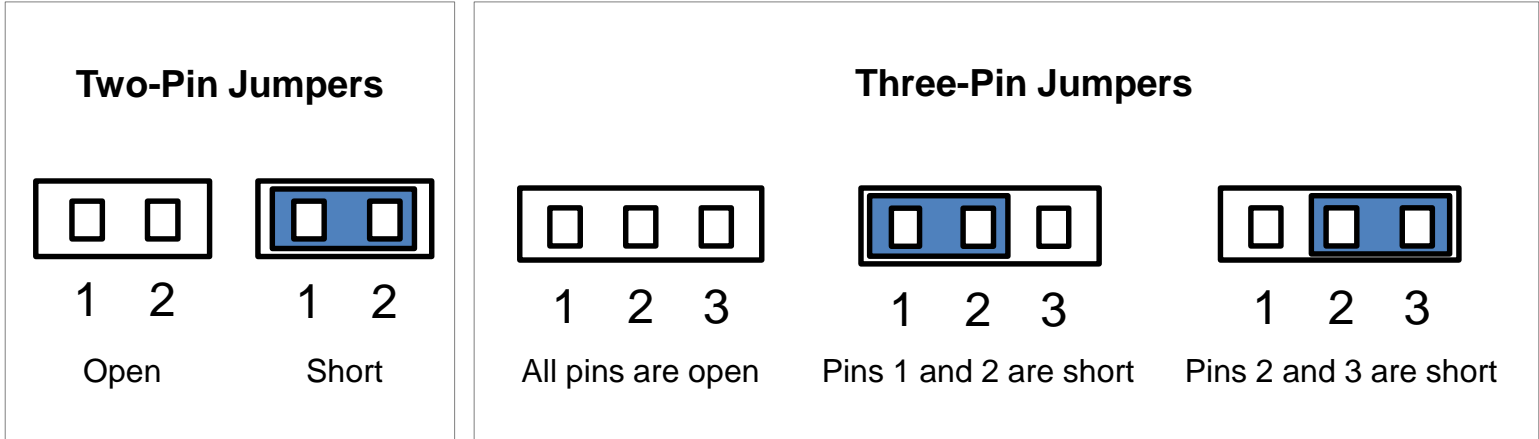

2.2 Locations of the Jumpers and Connectors

2.2.1 Top View

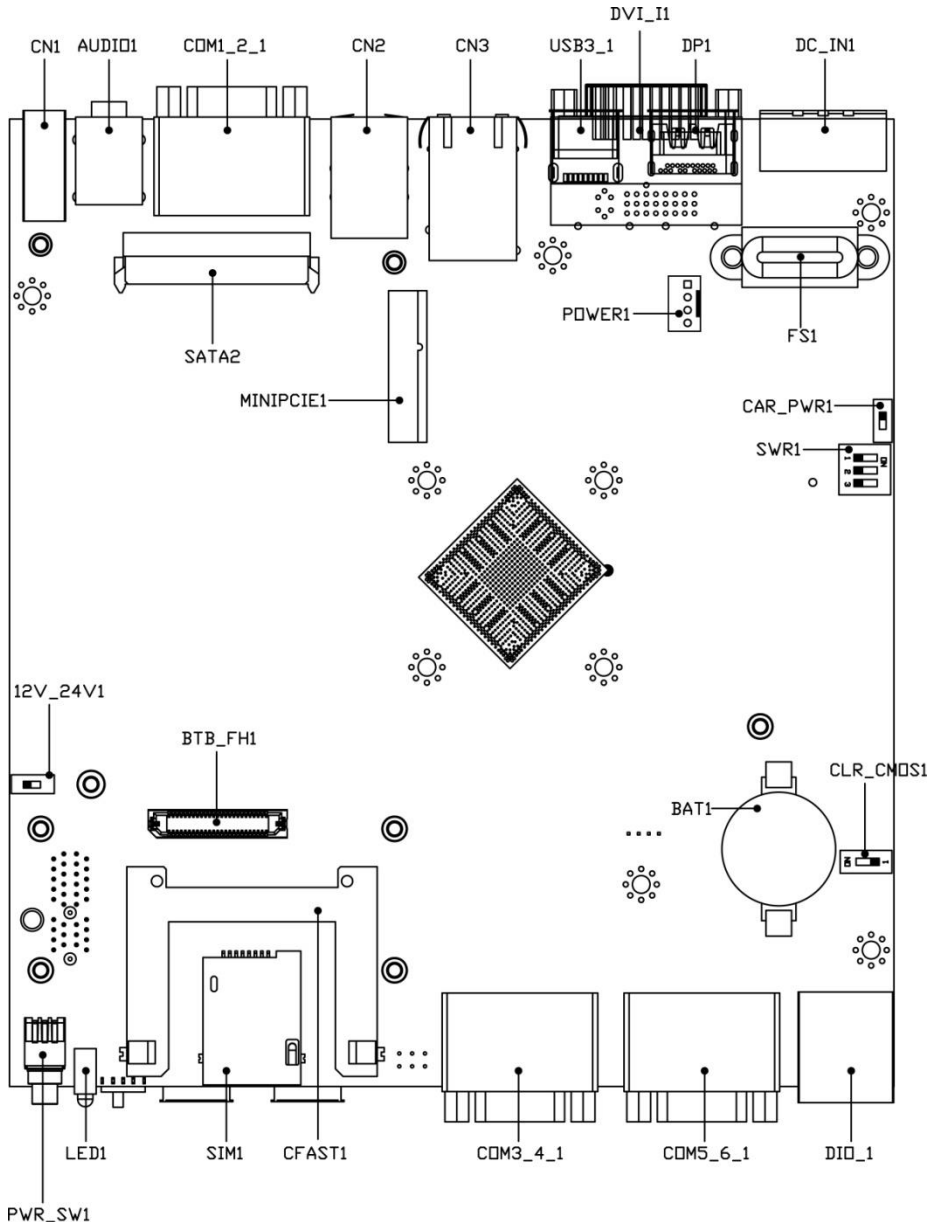

2.2.2 Bottom View

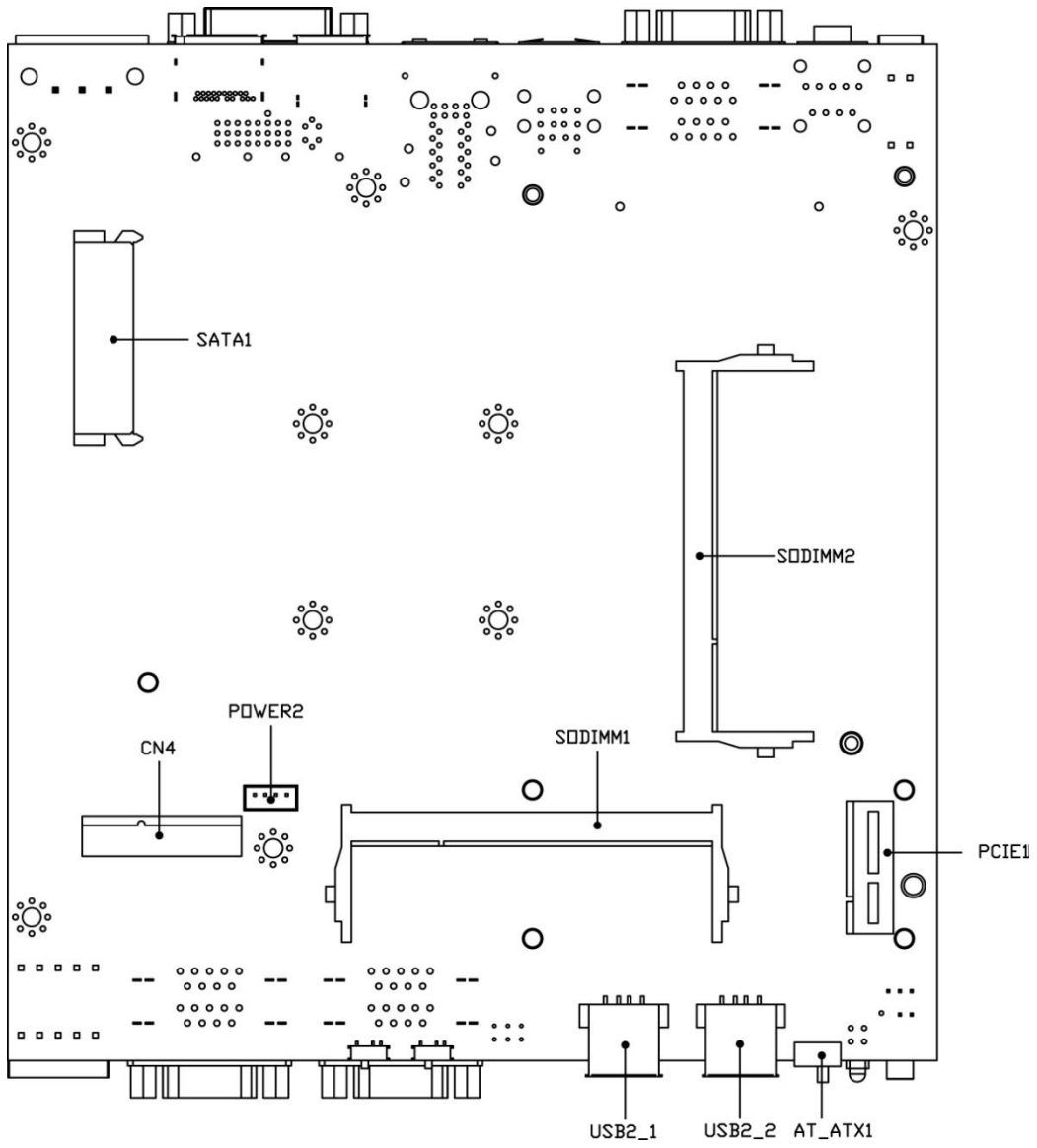

2.3 Connector / Jumper / Switch Definition

List of Connector / Jumper / Switch

Connector Location	Definition
12V_24V_1	12V / 24V Car Battery Switch
AT_ATX1	AT / ATX Power Mode Switch
AUDIO1	Audio Jack
CAR_PWR1	Car Power Enable / Disable Switch
CFAST1	CFast Connector
CLR_CMOS1	Clear CMOS Switch
CN1	Remote Power on / off Switch
CN2	PS/2 and USB2.0 Ports
CN3	LAN1 and LAN2 Ports
CN4	Mini PCI-Express / mSATA Socket
COM1_2_1, COM3_4_1, COM5_6_1	RS232 / RS422 / RS485 Connector
COM12_SEL1, COM34_SEL1, COM56_SEL1	COM1 / COM2 / COM3 / COM4 / COM5 / COM6 with Power Select
DC_IN1	3-pin DC 9~48V Power Input with Power Ignition Connector
DIO1	4DI / 4DO Connector
DP1	DisplayPort Connector
DVI_I1	DVI-I Connector
LED1	System LED Connector
MINIPCIE1	Mini PCI-Express Socket
PCIE1	PCI-Express X1 Socket
POWER1	Power Connector
POWER2	Power Connector
PWR_SW1	Power Switch
SATA1, SATA2	SATA with Power Connector
SIM1	SIM Card Socket
SW1	System Power off Timing Setting
USB2_1, USB2_2	USB 2.0 Ports
USB3_1	USB 3.0 Port

2.4 Switches Definition

AT_ATX1: AT / ATX Power Mode Switch (based on bottom view)

Pin	Definition
1-2 (Left)	AT Power Mode
2-3 (Right)	ATX Power Mode (Default)

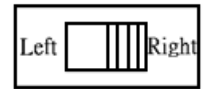

CLR_CMOS1: Clear CMOS Switch (based on top view)

Pin	Definition
1-2 (Right)	Normal Status (Default)
2-3 (Left)	Clear CMOS

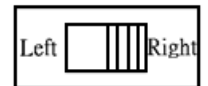

CN1: Remote Power on / off Switch

Pin	Definition
1	PWR_SW
2	RESET_SW
3	GND
4	GND

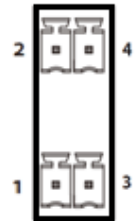

CAR_PWR1: Car Power Enable / Disable Switch (based on top view of section 2.2.1)

Pin	Definition
1-2	Car Power Disable (Default)
2-3	Car Power Enable

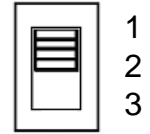
**12V_24V_1: 12V / 24V Car Battery Switch (based on top view)**

Pin	Definition
1-2	12V Car Battery Input (Default)
2-3	24V Car Battery Input

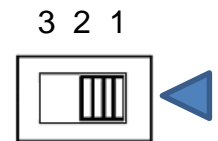
**SW1: Set shutdown delay timer when ACC is turned off**

Pin 1	Pin 2	Pin 3	Definition
OFF	OFF	OFF	0 second (Default)
ON	ON	OFF	1 minute
ON	OFF	ON	5 minutes
ON	OFF	OFF	10 minutes
OFF	ON	ON	30 minutes
OFF	ON	OFF	1 hour
OFF	OFF	ON	2 hours
ON	ON	ON	Reserved

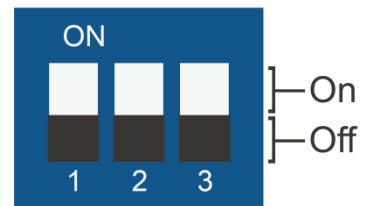

When ignition (IGN or ACC) is turned on, the system will power on in 10 seconds. When the system has shut down with IGN switched off and the shutdown delay timer, it needs at least 60 seconds to be able to start ignition again.

PWR_SW1: Power Switch

Pin	Definition
1	NC
2	Power Button
3	NC
4	GND
5	NC
6	GND



2.5 Jumpers Definition

COM12_SEL1: COM1 / COM2 with Power Select

Connector Type: 2X5 10-pin Header, 2.54mm pitch

COM1		COM2	
Pin	Definition	Pin	Definition
1-3 On	+5V	2-4 On	+5V
3-5 On	+12V	4-6 On	+12V
7-9 On (Default)	Reserved	8-10 On (Default)	Reserved

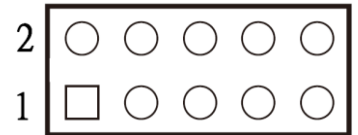

COM34_SEL1: COM3 / COM4 with Power Select

Connector Type: 2X5 10-pin Header, 2.54mm pitch

COM3		COM4	
Pin	Definition	Pin	Definition
1-3 On	+5V	2-4 On	+5V
3-5 On	+12V	4-6 On	+12V
7-9 On (Default)	Reserved	8-10 On (Default)	Reserved

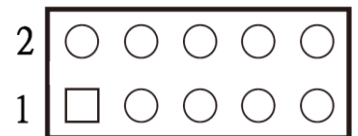

COM56_SEL1: COM5 / COM6 with Power Select

Connector Type: 2X5 10-pin Header, 2.54mm pitch

COM5		COM6	
Pin	Definition	Pin	Definition
1-3 On	+5V	2-4 On	+5V
3-5 On	+12V	4-6 On	+12V
7-9 On (Default)	Reserved	8-10 On (Default)	Reserved

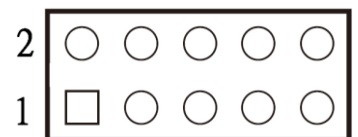

2.6 Connector Definition

CFAST1: CFast Connector

Pin	Definition	Pin	Definition	Pin	Definition
S1	GND	PC1	NC	PC10	NC
S2	TX+	PC2	GND	PC11	NC
S3	TX-	PC3	NC	PC12	NC
S4	GND	PC4	NC	PC13	+3.3V
S5	RX-	PC5	NC	PC14	+3.3V
S6	RX+	PC6	NC	PC15	GND
S7	GND	PC7	GND	PC16	GND
		PC8	NC	PC17	NC
		PC9	NC		

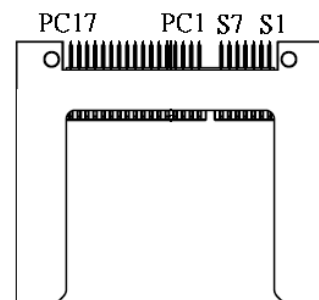

COM1_2_1: RS232 / RS422 / RS485 Connector

Connector Type: 9-pin D-Sub

COM1			
Pin	RS232 Definition	RS422 / 485 Full Duplex Definition	RS485 Half Duplex Definition
1	DCD1	TX1-	DATA1-
2	RxD1	TX1+	DATA1+
3	TxD1	RX1+	
4	DTR1	RX1-	
5	GND1		
6	DSR1		
7	RTS1		
8	CTS1		
9	RI1		

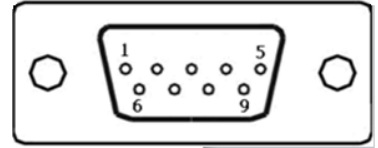

Power over Serial PIN Definitions			
Pin	RS232	RS422/485	RS485
5	GND	GND	GND
9	0/5/12V	0/5/12V	0/5/12V

COM2			
Pin	RS232 Definition	RS422 / 485 Full Duplex Definition	RS485 Half Duplex Definition
10	DCD2	TX2-	DATA2-
11	RxD2	TX2+	DATA2+
12	TxD2	RX2+	
13	DTR2	RX2-	
14	GND2		
15	DSR2		
16	RTS2		
17	CTS2		
18	RI2		

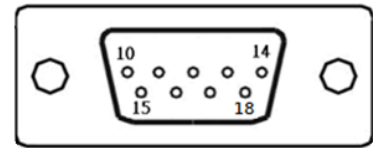

Power over Serial PIN Definitions			
Pin	RS232	RS422/485	RS485
14	GND	GND	GND
18	0/5/12V	0/5/12V	0/5/12V

COM3_4_1: RS232 / RS422 / RS485 Connector

Connector Type: 9-pin D-Sub

COM3			
Pin	RS232 Definition	RS422 / 485 Full Duplex Definition	RS485 Half Duplex Definition
1	DCD3	TX3-	DATA3-
2	RxD3	TX3+	DATA3+
3	TxD3	RX3+	
4	DTR3	RX3-	
5	GND3		
6	DSR3		
7	RTS3		
8	CTS3		
9	RI3		

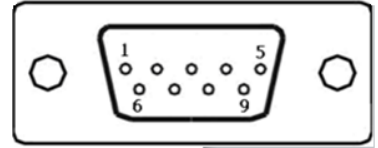

Power over Serial PIN Definitions			
Pin	RS232	RS422/485	RS485
5	GND	GND	GND
9	0/5/12V	0/5/12V	0/5/12V

COM4			
Pin	RS232 Definition	RS422 / 485 Full Duplex Definition	RS485 Half Duplex Definition
10	DCD4	TX4-	DATA4-
11	RxD4	TX4+	DATA4+
12	TxD4	RX4+	
13	DTR4	RX4-	
14	GND4		
15	DSR4		
16	RTS4		
17	CTS4		
18	RI4		

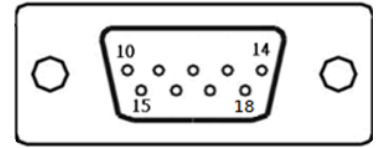

Power over Serial PIN Definitions			
Pin	RS232	RS422/485	RS485
14	GND	GND	GND
18	0/5/12V	0/5/12V	0/5/12V

COM5_6_1: RS232 / RS422 / RS485 Connector

Connector Type: 9-pin D-Sub

COM5			
Pin	RS232 Definition	RS422 / 485 Full Duplex Definition	RS485 Half Duplex Definition
1	DCD5	TX5-	DATA5-
2	RxD5	TX5+	DATA5+
3	TxD5	RX5+	
4	DTR5	RX5-	
5	GND5		
6	DSR5		
7	RTS5		
8	CTS5		
9	RI5		

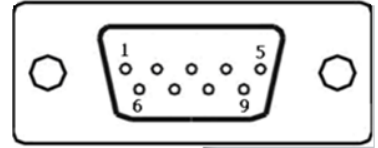

Power over Serial PIN Definitions			
Pin	RS232	RS422/485	RS485
5	GND	GND	GND
9	0/5/12V	0/5/12V	0/5/12V

COM6			
Pin	RS232 Definition	RS422 / 485 Full Duplex Definition	RS485 Half Duplex Definition
10	DCD6	TX6-	DATA6-
11	RxD6	TX6+	DATA6+
12	TxD6	RX6+	
13	DTR6	RX6-	
14	GND6		
15	DSR6		
16	RTS6		
17	CTS6		
18	RI6		

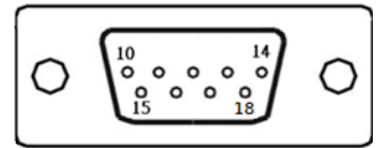

Power over Serial PIN Definitions			
Pin	RS232	RS422/485	RS485
14	GND	GND	GND
18	0/5/12V	0/5/12V	0/5/12V

DC_IN1: DC Power Input Connector (+9~48V)

Connector Type: Terminal Block 1X3 3-pin, 5.0mm pitch

Pin	Definition
1	+9~48VIN
2	Ignition (IGN)
3	GND

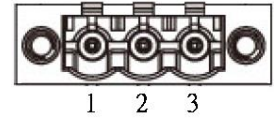

DIO1: Digital Input / Output Connector

Connector Type: Terminal Block 2X5 10-pin, 3.5mm pitch

Pin	Definition	Pin	Definition
1	DI1	2	DO1
3	DI2	4	DO2
5	DI3	6	DO3
7	DI4	8	DO4
9	DC INPUT	10	GND

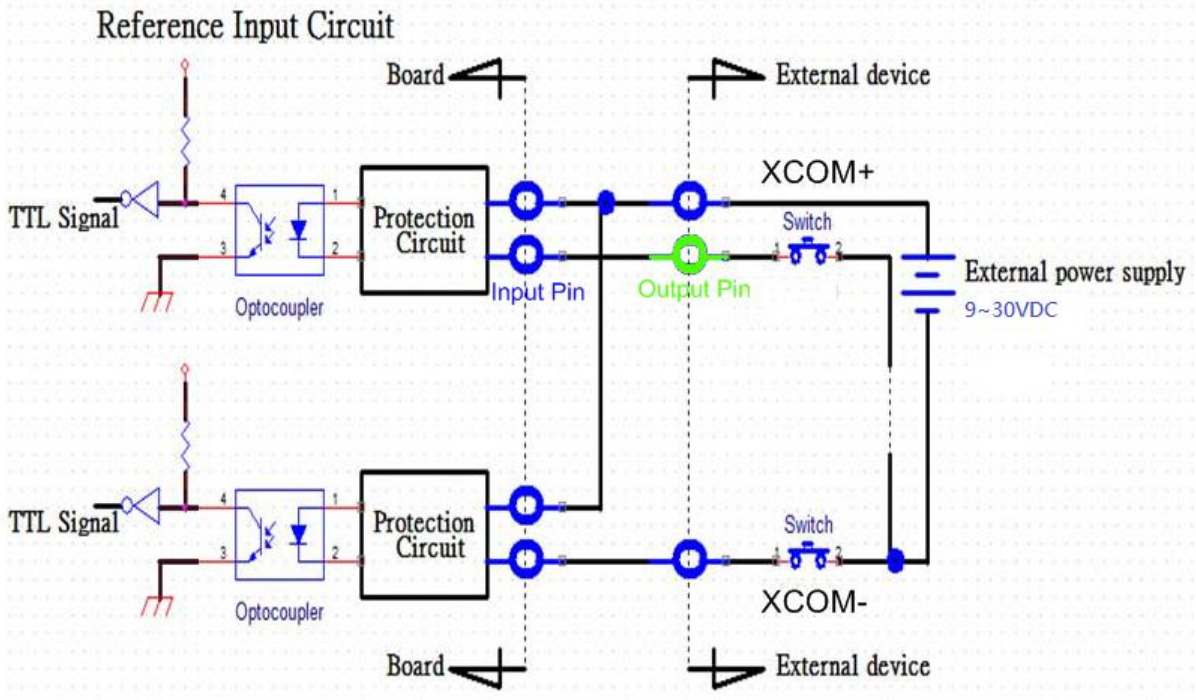
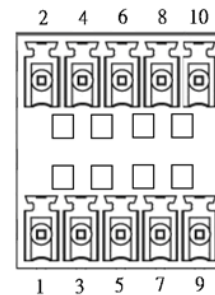

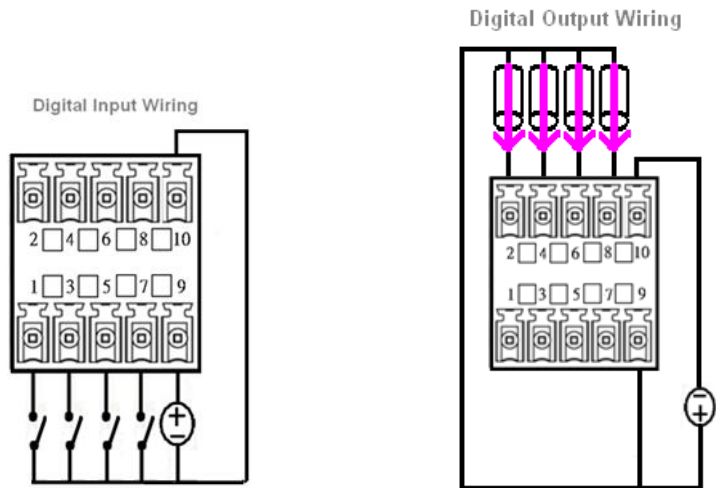
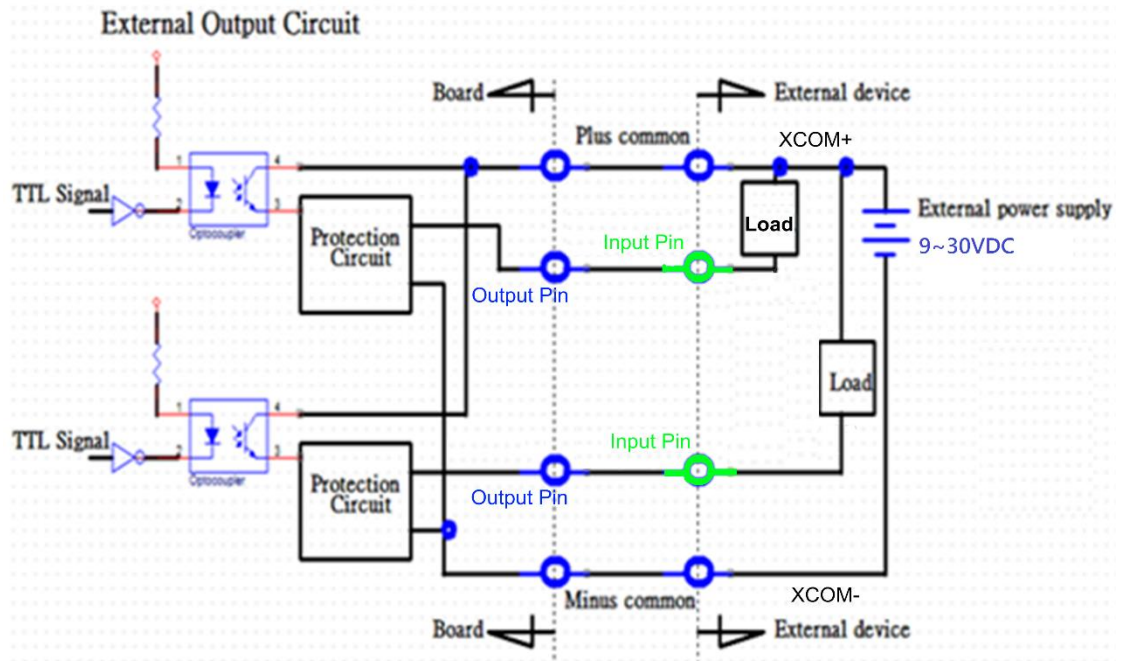

DP1: DisplayPort Connector

Pin	Definition	Pin	Definition
1	DPC_LANE0_P	11	GND
2	GND	12	DPC_LANE3_N
3	DPC_LANE0_N	13	GND
4	DPC_LANE1_P	14	GND
5	GND	15	DPC_AUX_P
6	DPC_LANE1_N	16	GND
7	DPC_LANE2_P	17	DPC_AUX_N
8	GND	18	DPC_HPD
9	DPC_LANE2_N	19	GND
10	DPC_LANE3_P	20	DPC_PWR

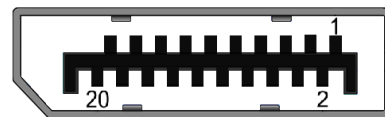
**DVI_I1: DVI-I Connector**

Pin	Definition	Pin	Definition
1	DVI_TX2-	16	DVI Hot Plug Detect
2	DVI_TX2+	17	DVI_TX0-
3	GND	18	DVI_TX0+
4	NC	19	GND
5	NC	20	NC
6	DDC_CLOCK	21	NC
7	DDC_DATA	22	GND
8	VGA_VSYNC	23	DVI_TXCLK+
9	DVI_TX1-	24	DVI_TXCLK-
10	DVI_TX1+	C1	VGA_RED
11	GND	C2	VGA_GREEN
12	NC	C3	VGA_BLUE
13	NC	C4	VGA_HSYNC
14	+5V	C5	GND
15	GND		

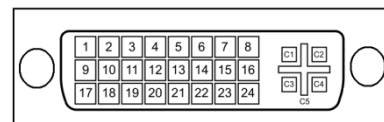

CN2: PS/2 and USB2.0 Ports

Connector Type: 6-pin Mini-DIN and dual USB 2.0 ports

Pin	Definition	Pin	Definition	Pin	Definition
1	+5V	5	+5V	9	+5V
2	USB_HUB_D1-	6	USB_HUB_D2-	10	MS_DATA
3	USB_HUB_D1+	7	USB2_HUB_D2+	11	KB_DATA
4	GND	8	GND	12	GND
				13	MS_CLK
				14	KB_CLK

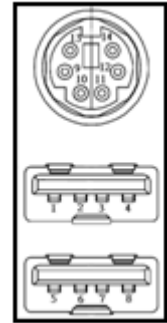

CN3: LAN1 and LAN2 Ports

Connector Type: RJ45 with LEDs Port

Pin	Definition	Pin	Definition
A1	LAN1_MDI0P	A5	LAN1_MDI2N
A2	LAN1_MDI0N	A6	LAN1_MDI1N
A3	LAN1_MDI1P	A7	LAN1_MDI3P
A4	LAN1_MDI2P	A8	LAN1_MDI3N
B1	LAN2_MDI0P	B5	LAN2_MDI2N
B2	LAN2_MDI0N	B6	LAN2_MDI1N
B3	LAN2_MDI1P	B7	LAN2_MDI3P
B4	LAN2_MDI2P	B8	LAN2_MDI3N

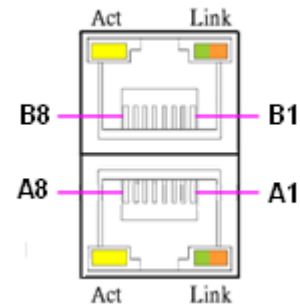

Act LED Status	Definition	Link LED Status	Definition
Blinking Yellow	Data Activity	Steady Green	1Gbps Network Link
Off	No Activity	Steady Orange	100Mbps Network Link
		Off	10Mbps Network Link

CN4: Mini PCI-Express / mSATA Socket

Pin	Definition	Pin	Definition	Pin	Definition
1	WAKE#	19	NC	37	GND
2	+3.3V	20	+3.3V	38	USB2_D+
3	NC	21	GND	39	+3.3V
4	GND	22	MINIPCIE_RST#	40	GND
5	NC	23	MINIPCIE_RXN / SATA_RXP	41	+3.3V
6	+1.5V	24	+3.3V	42	NC
7	CLKREQ#	25	MINIPCIE_RXP / SATA_RXN	43	GND
8	NC	26	GND	44	NC
9	GND	27	GND	45	NC
10	NC	28	+1.5V	46	NC
11	MINIPCIE_CLKN	29	GND	47	NC
12	NC	30	SMB_CLK	48	+1.5V
13	MINIPCIE_CLKP	31	MINIPCIE_TXN / SATA_TXN	49	NC
14	NC	32	SMB_DATA	50	GND
15	GND	33	MINIPCIE_TXP / SATA_TXP	51	NC
16	NC	34	GND	52	+3.3V
17	NC	35	GND		
18	GND	36	USB2_D-		

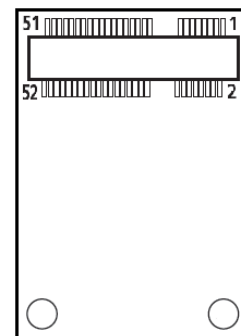
**AUDIO1: Line-out Jack (Green) and Microphone Jack (Pink)**

Connector Type: 5-pin Phone Jack

Pin	Definition	Pin	Definition
1	GND	22	OUT_L
2	MIC_L	23	GND
3	GND	24	OUT_JD
4	MIC_JD	25	OUT_R
5	MIC_R		

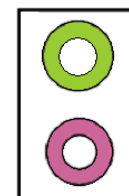

MINIPCIE1: Mini PCI-Express Socket

Pin	Definition	Pin	Definition	Pin	Definition
1	WAKE#	19	NC	37	GND
2	+3.3V	20	+3.3V	38	USB2_D+
3	NC	21	GND	39	+3.3V
4	GND	22	MINIPCIE_RST#	40	GND
5	NC	23	MINIPCIE_RXN7	41	+3.3V
6	+1.5V	24	+3.3V	42	NC
7	CLKREQ#	25	MINIPCIE_RXP7	43	GND
8	UIM_PWR	26	GND	44	NC
9	GND	27	GND	45	NC
10	UIM_DATA	28	+1.5V	46	NC
11	MINIPCIE_CLKN	29	GND	47	NC
12	UIM_CLK	30	SMB_CLK	48	+1.5V
13	MINIPCIE_CLKP	31	MINIPCIE_TXN	49	NC
14	UIM_RESET	32	SMB_DATA	50	GND
15	GND	33	MINIPCIE_TXP	51	NC
16	UIM_VPP	34	GND	52	+3.3V
17	NC	35	GND		
18	GND	36	USB2_D-		

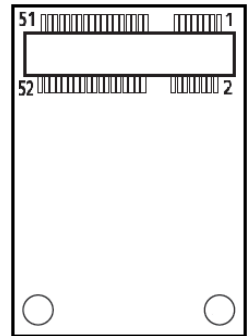

PCIE2: PCI-Express X1 Socket

Connector Type: PCI-Express X1 Slot

Pin	Definition	Pin	Definition
A1	CPUFAN_CONTROL	B1	+12V
A2	+12V	B2	+12V
A3	+12V	B3	+12V
A4	GND	B4	GND
A5	NC	B5	SMB_CLK
A6	NC	B6	SMB_DATA
A7	NC	B7	GND
A8	NC	B8	+3.3V
A9	+3.3V	B9	NC
A10	+3.3V	B10	+3.3VSB
A11	PCIE_RESET#	B11	PCIE_WAKE#
A12	GND	B12	+12V
A13	PCIE_CLKP	B13	GND
A14	PCIE_CLKN	B14	PCIE_TXP
A15	GND	B15	PCIE_TXN
A16	PCIE_RXP	B16	GND
A17	PCIE_RXN	B17	CPUFAN_SENSE
A18	GND	B18	GND

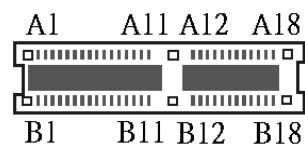

POWER1: Power Connector

Connector Type: 1X4-pin Wafer, 2.54mm pitch

Pin	Definition
1	+5V
2	GND
3	GND
4	+12V

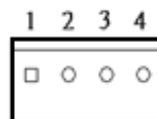

POWER2: Power Connector

Connector Type: 1X4-pin Wafer, 2.0mm pitch

Pin	Definition
1	+5V
2	GND
3	GND
4	+12V

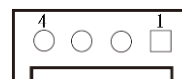

USB2_1, USB2_2: USB2.0 Connector, Type A

Pin	USB2_1 Definition	USB2_2 Definition
1	+5V	+5V
2	USB_HUB_D3-	USB_HUB_D4-
3	USB_HUB_D3+	USB_HUB_D4+
4	GND	GND

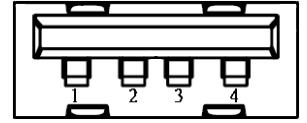
**USB3_1: USB 3.0 Port , Type A**

Pin	Definition	Pin	Definition
1	+5V	6	USB3_RX+
2	USB_HUB_D5-	7	GND
3	USB_HUB_D5+	8	USB3_TX-
4	GND	9	USB3_TX+
5	USB3_RX-		

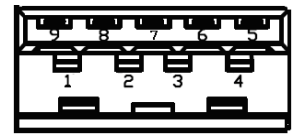



Chapter 3

System Setup

3.1 Removing the Chassis Bottom Cover



WARNING

In order to prevent electric shock or system damage, before removing the chassis cover, must turn off power and disconnect the unit from power source.

1. Flip over the unit to have the bottom side up. Loosen the 6 screws from bottom cover and place them aside for later use.



2. Remove the cover from the chassis.



3.2 Removing the Chassis

1. Loosen 4 screws as they are marked on photo, remove the base holders, and place them aside for later use.

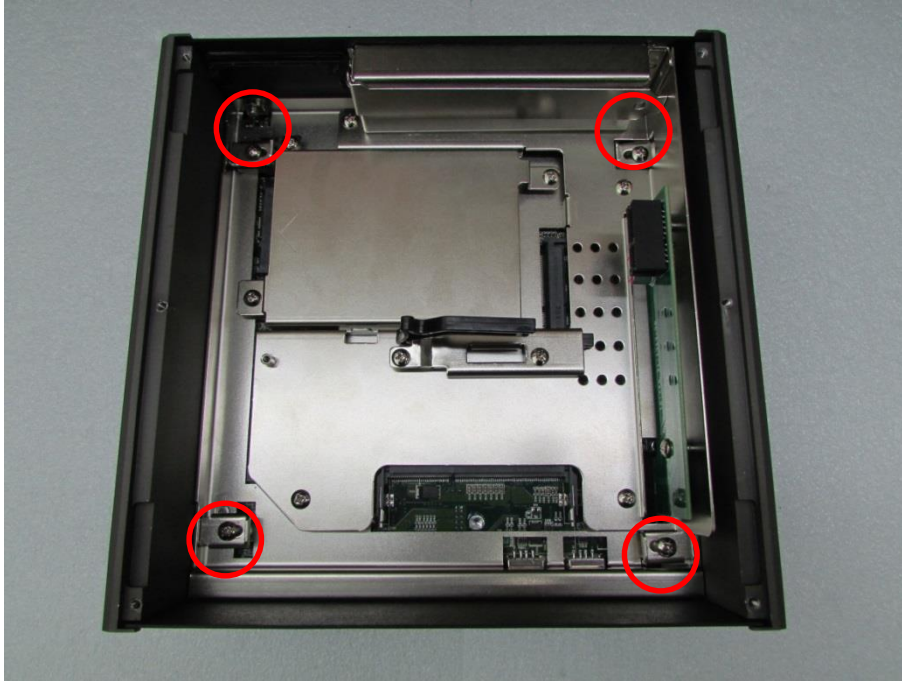

2. Lift up the body unit vertically by holding the front and rear panel.

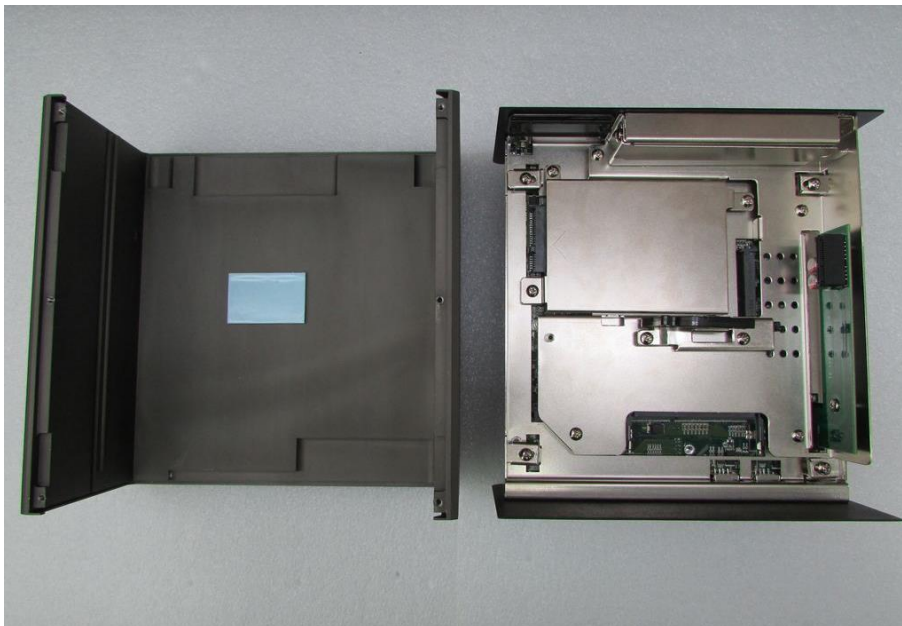

3.3 Installing a Half Size Mini PCIe Card on Upper Side

1. Flip over the body unit and place it on the table gently.

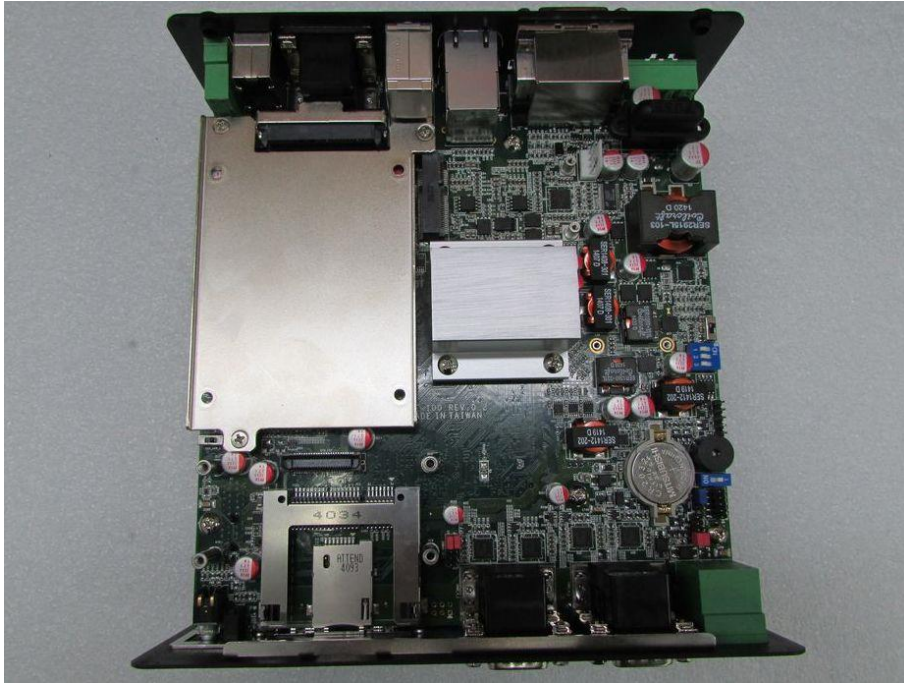

2. Locate the Mini PCIe slot.

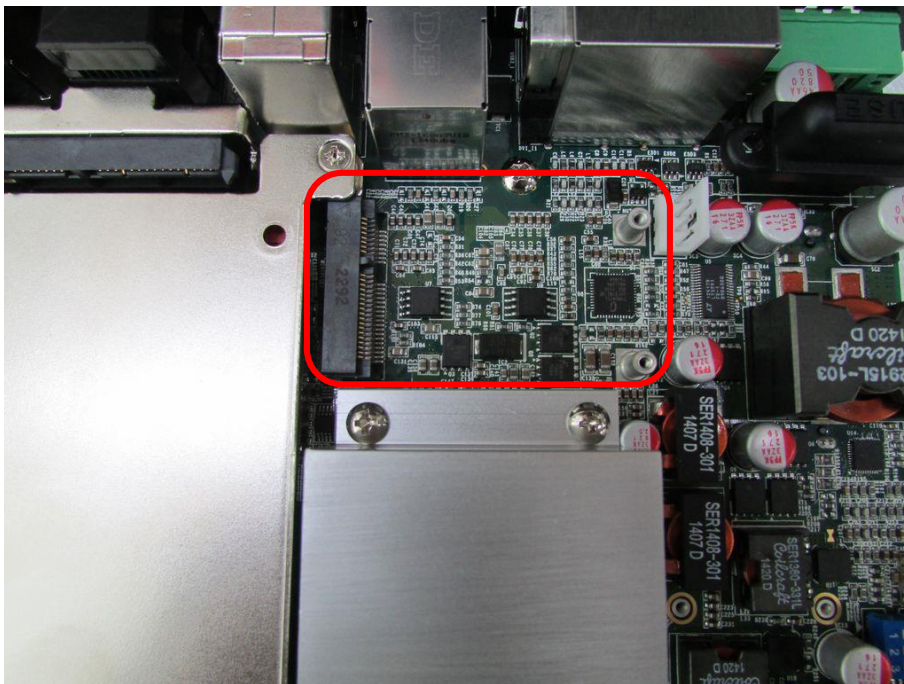

3. Fasten the module and bracket together with 2 screws.



4. Tilt the Mini PCIe module at 45 degree angle and insert it to the Mini PCIe slot. Be sure the gold-plated connects to the Mini PCIe slot firmly.

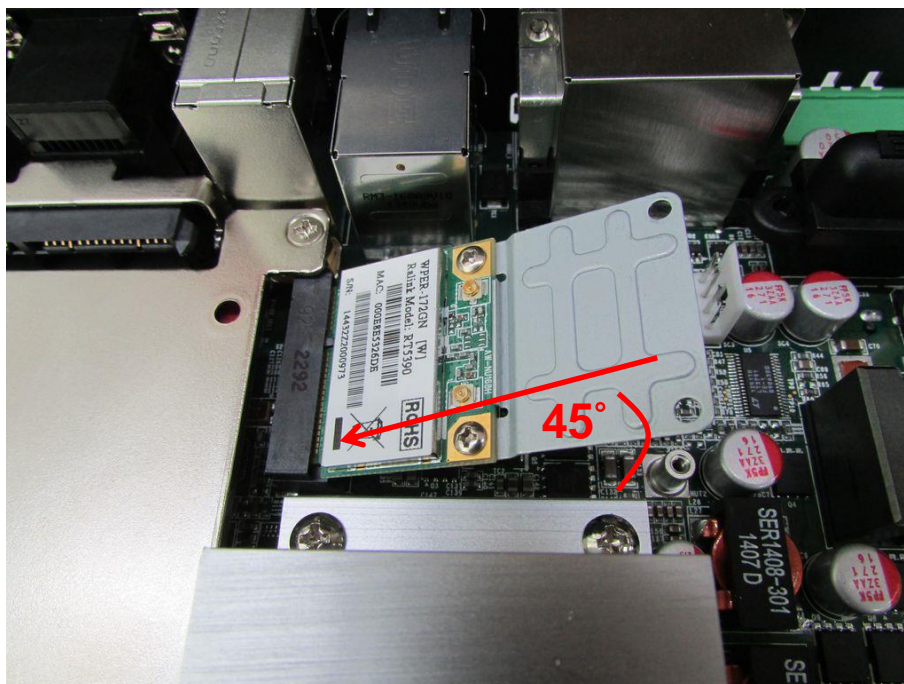

5. Press down the module and fasten the module with 2 screws.

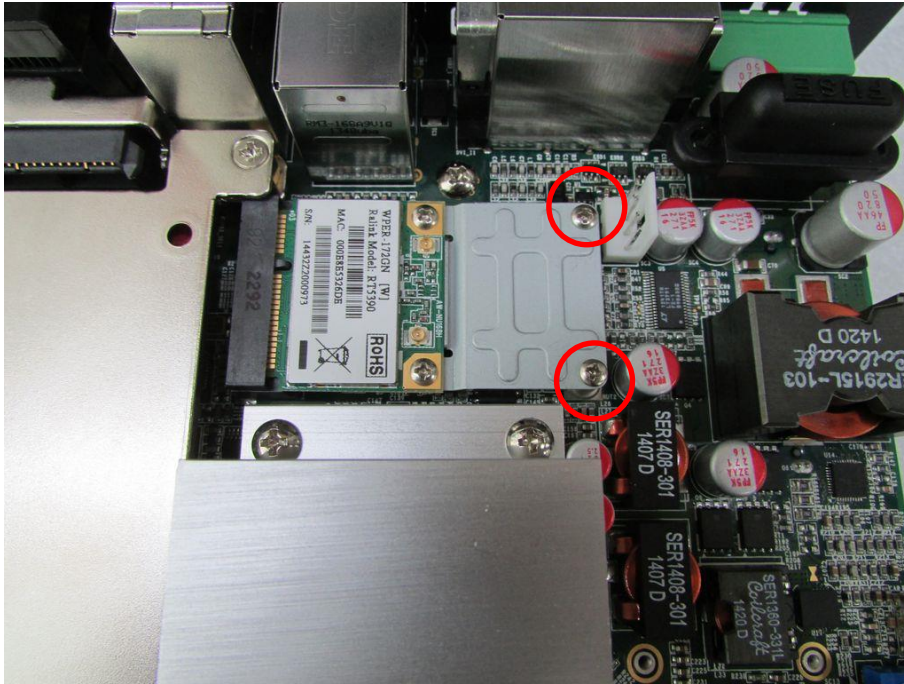

3.4 Installing a Full Size Mini PCIe Card on Upper Side

1. Flip over the body unit and place it on the table gently.

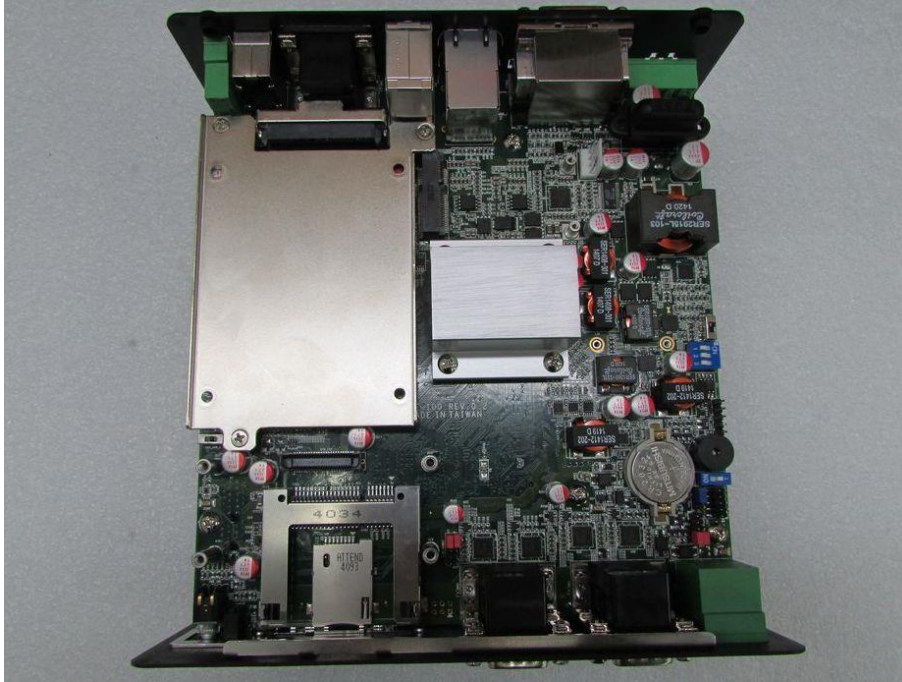

2. Locate the Mini PCIe slot.

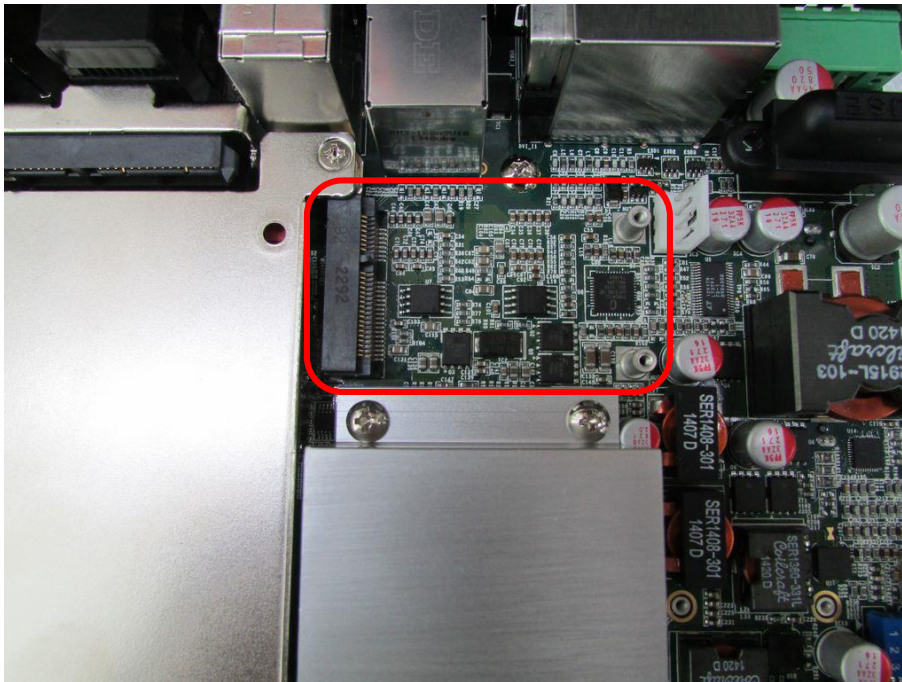

3. Tilt the Mini PCIe module at 45 degree angle and insert it to the Mini PCIe slot. Be sure the gold-plated connects to the Mini PCIe slot firmly.

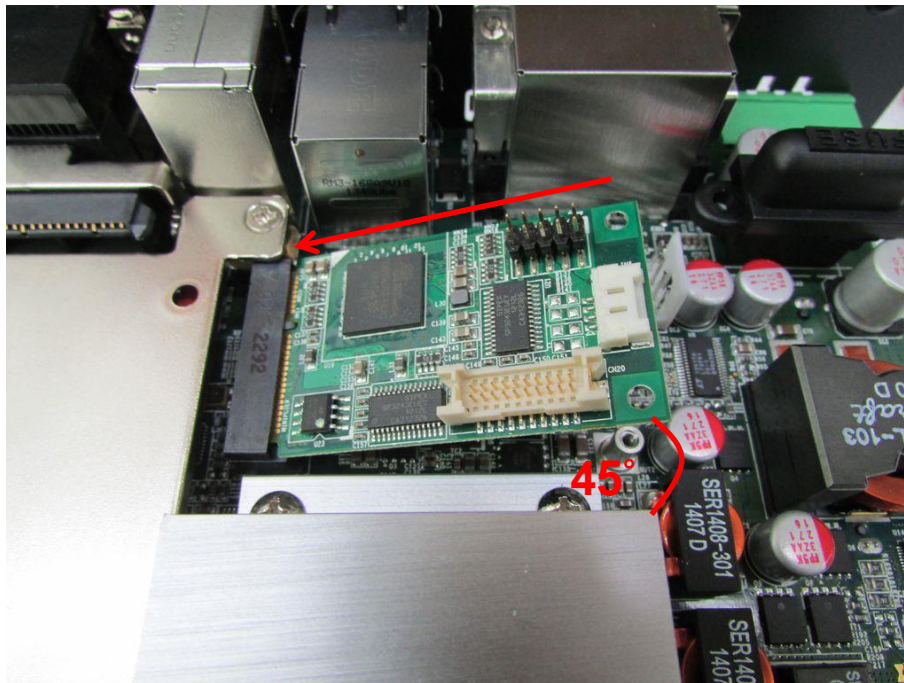

4. Press down the module and fasten the module with 2 screws.

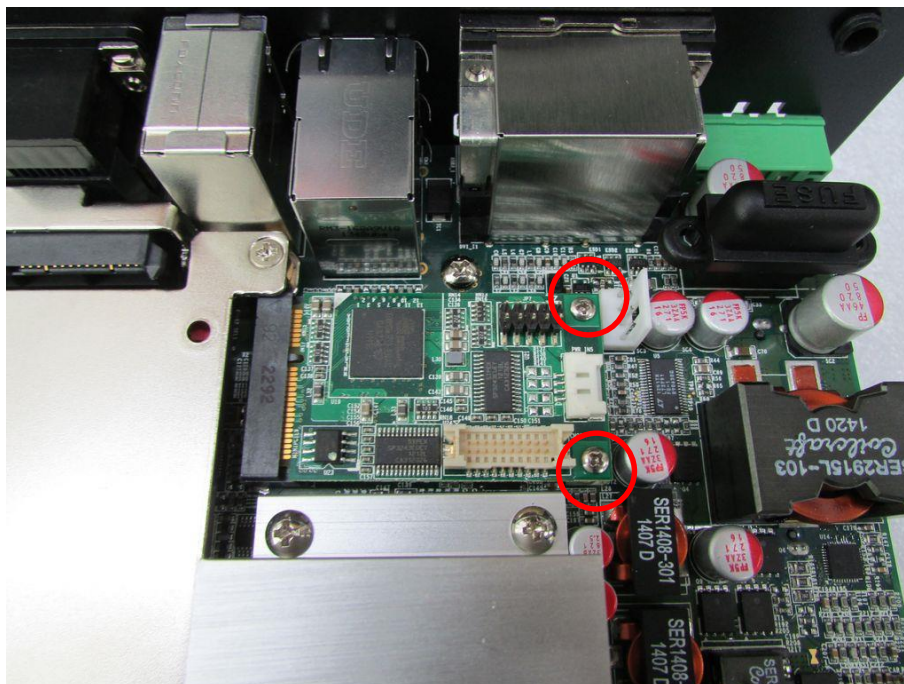

3.5 Installing Antenna



CAUTION

Please installing a Mini PCIe Wireless LAN Card on top side before you put on washer and fasten the nut with antenna jack.

1. Remove the antenna covers on rear panel.



2. Have antenna jack penetrate through the hole.



3. Place on washer and fasten the nut with antenna jack.



4. Assemble the antenna and antenna jack together.



5. Attach the RF connector at the other end of cable onto the module.

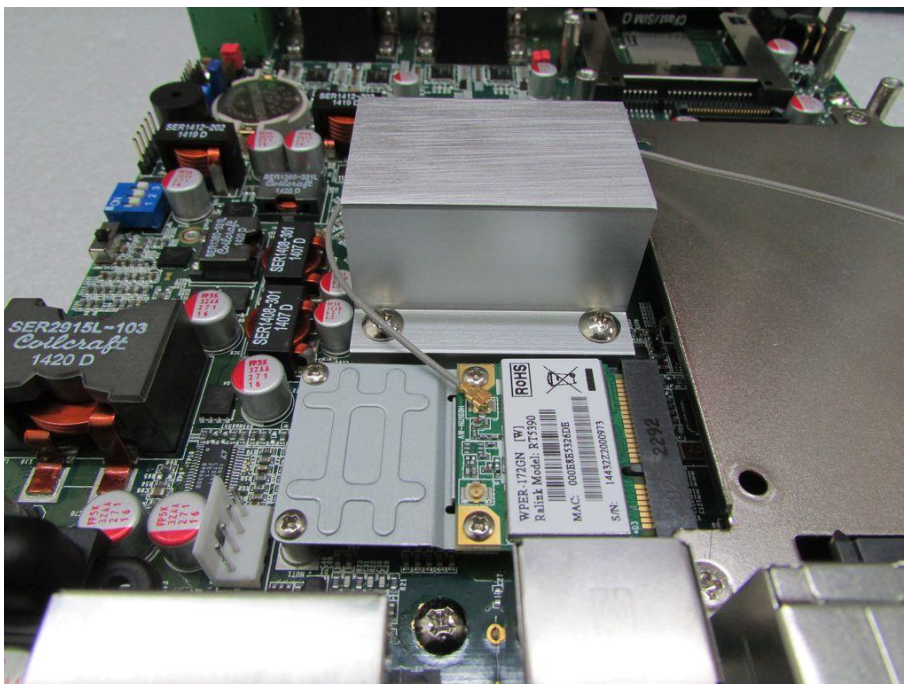

3.6 Installing a SATA Hard Drive on Upper Side

1. Flip over the body unit and place it on the table gently.

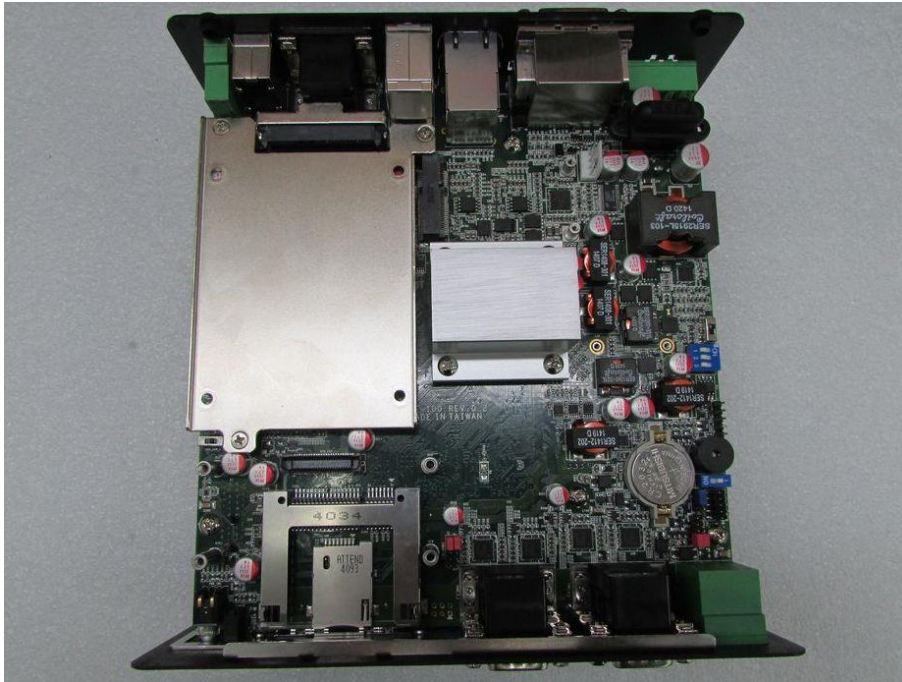

2. Loosen the 3 screws on HDD bracket and remove the bracket.

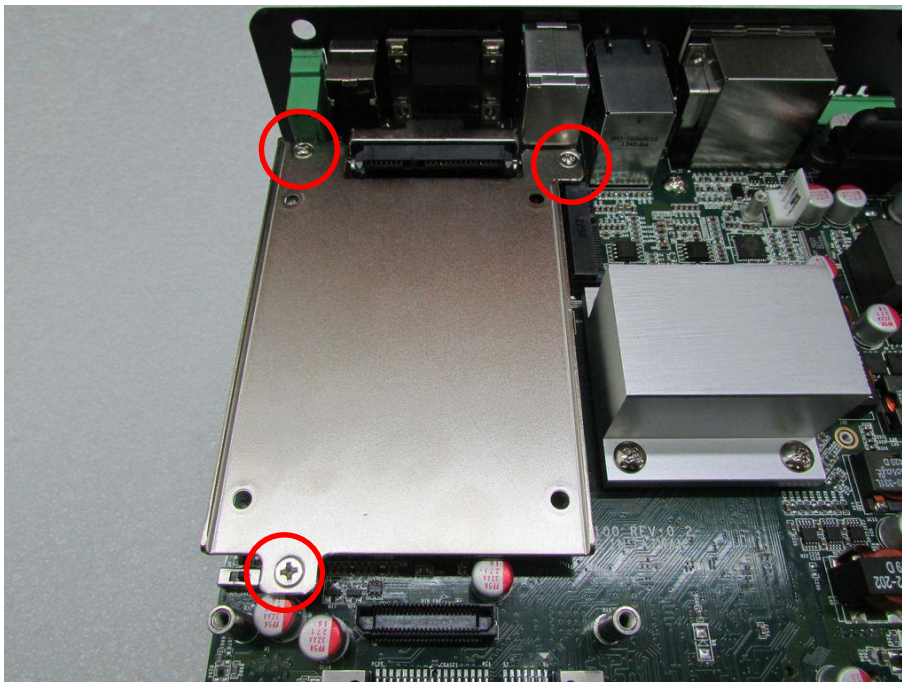

- To have PCB side up, place the HDD bracket on it. Ensure the direction of bracket is correct and use 4 provided screws to fasten HDD and HDD bracket together.



- Flip over the HDD bracket. Connect the HDD bracket to the SATA connector and fasten it with 3 screws.

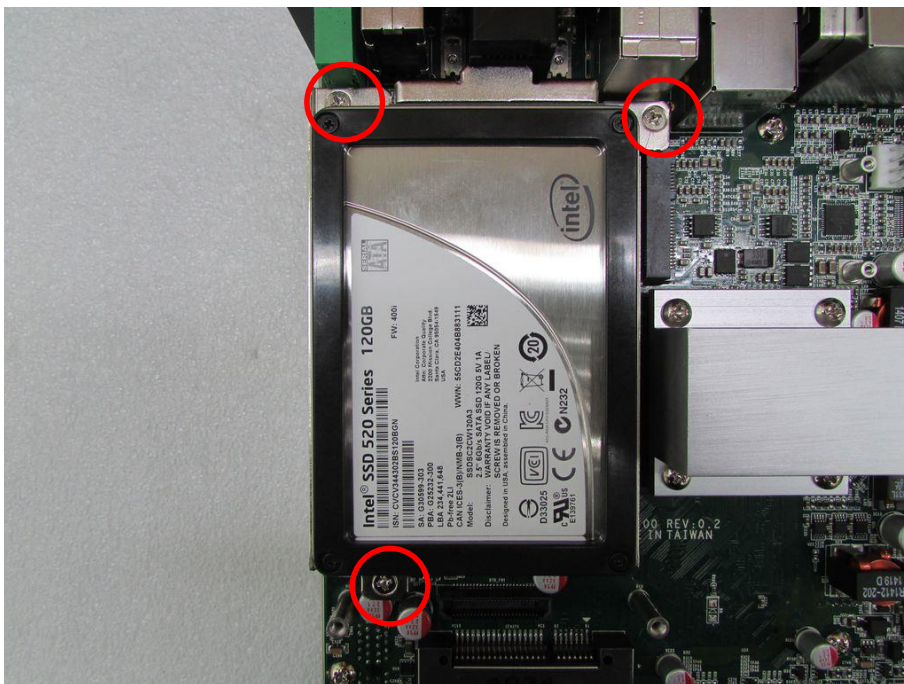

3.7 Installing a SATA Hard Drive on Bottom Side

1. Flip over the body unit and locate SATA socket on the bottom side. Loosen the 3 screws on HDD bracket and remove the bracket.

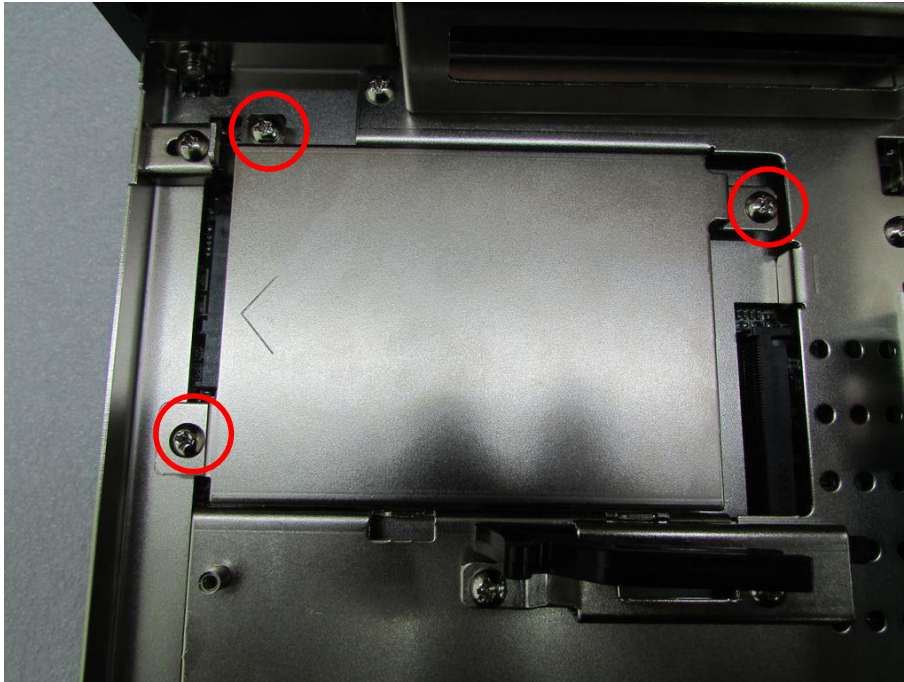

2. To have the PCB side up, and place the HDD on HDD bracket. Ensure the direction of bracket is correct and use 4 provided screws to fasten HDD and HDD bracket together.

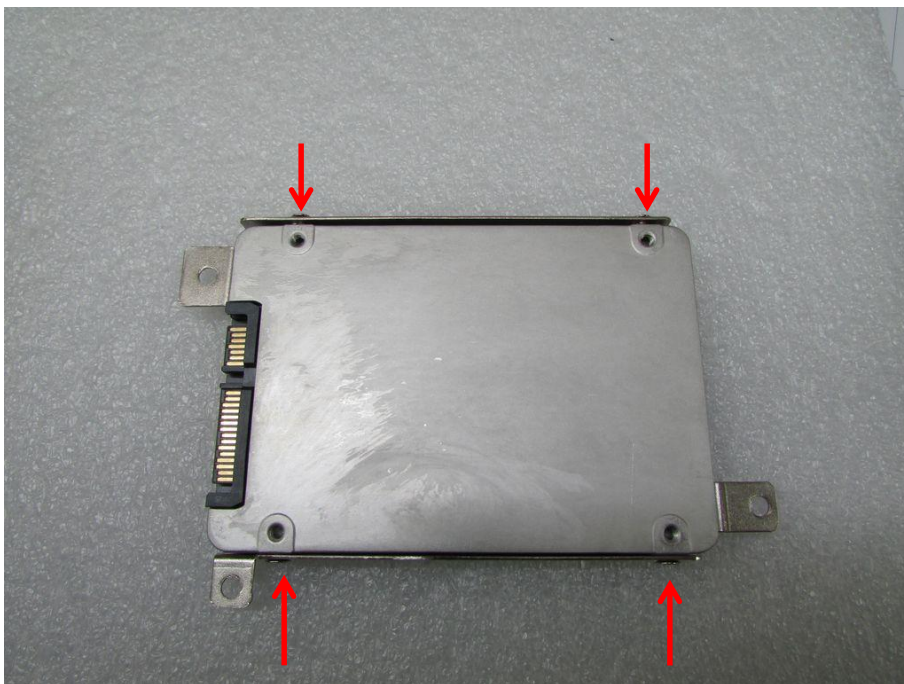

3. Flip over the HDD bracket. Connect the HDD bracket to SATA connector and fasten it with 3 screws.

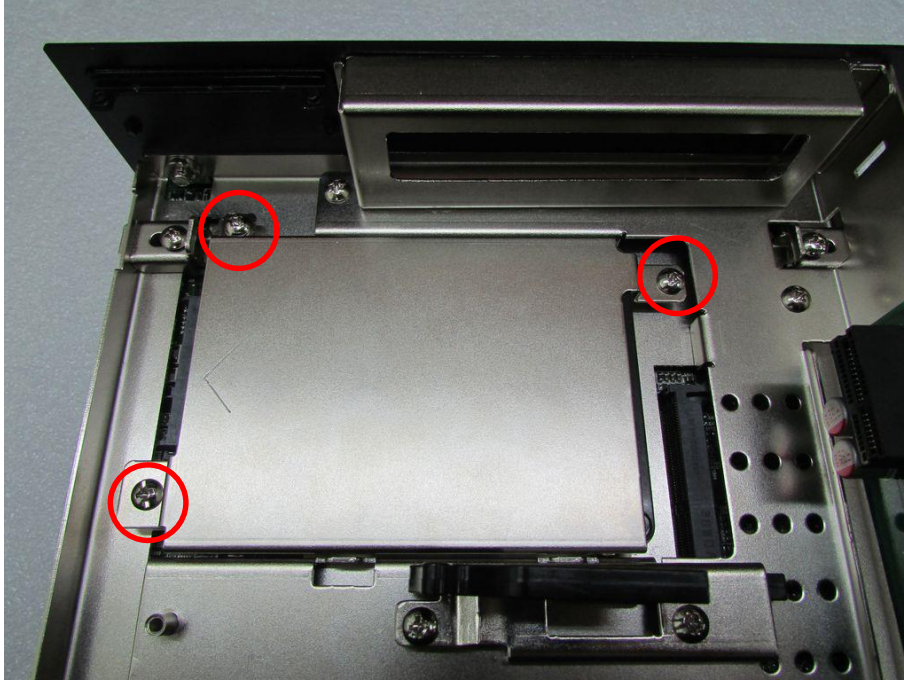

3.8 Installing SO-DIMM 1

1. Flip over the body unit and locate SO-DIMM socket on the bottom.

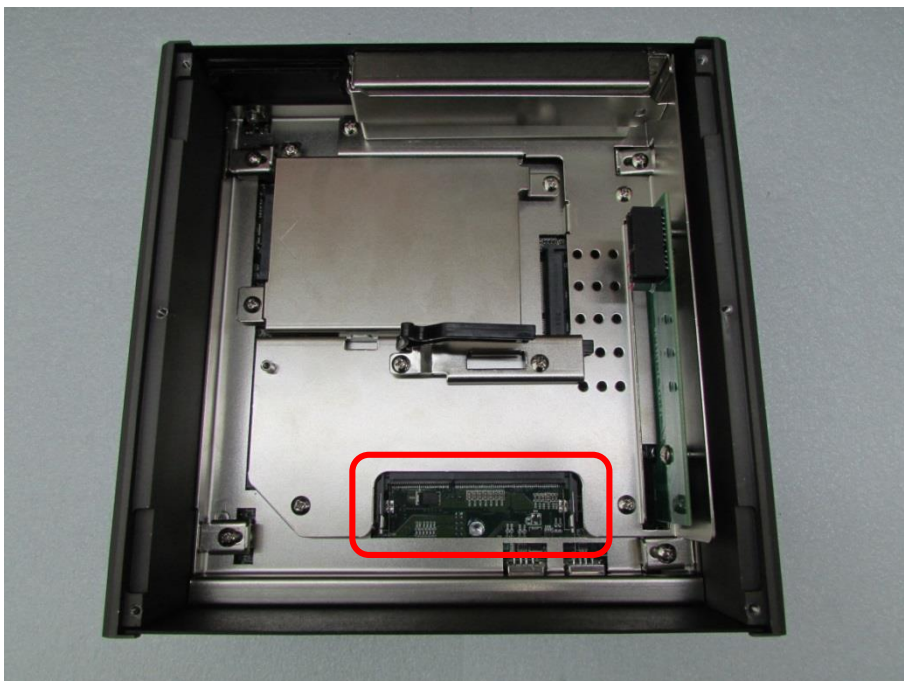

2. Tilt the SO-DIMM module at 45 degree angle and insert it to SO-DIMM socket. Be sure the gold-plated connects to SO-DIMM slot firmly.

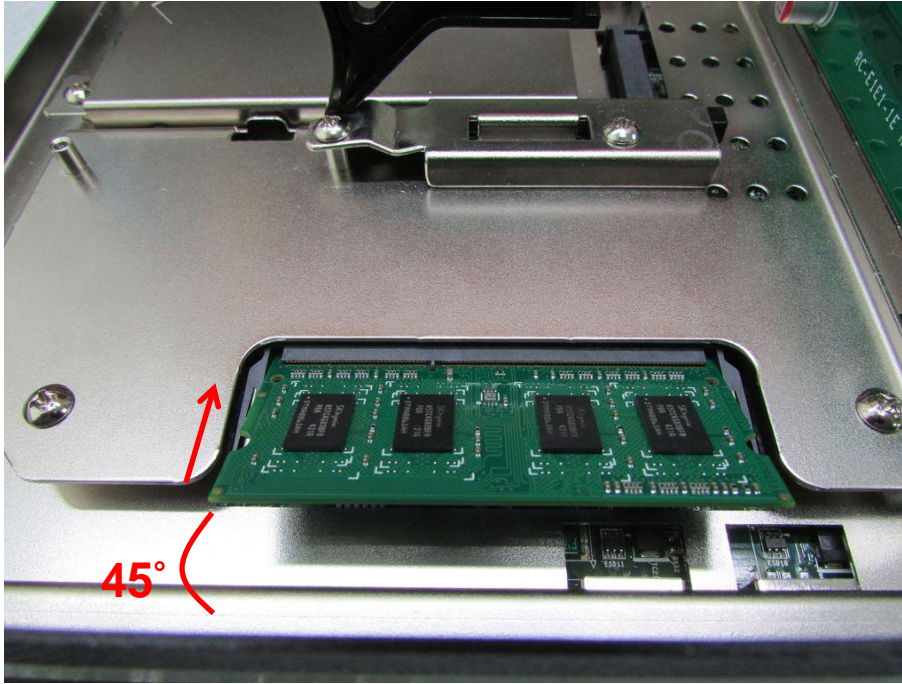

3. Press the module down until its fixed firmly by the two locking latches on each side.

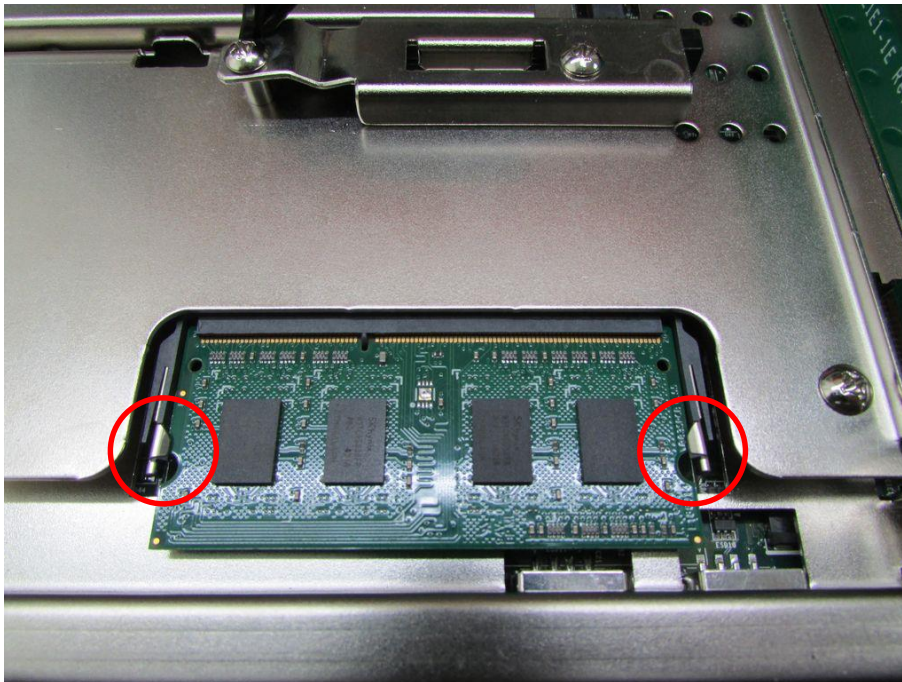

3.9 Installing SO-DIMM 2

1. Flip over the body unit and locate SO-DIMM socket on the bottom. Loosen screws and take expansion module out of system.

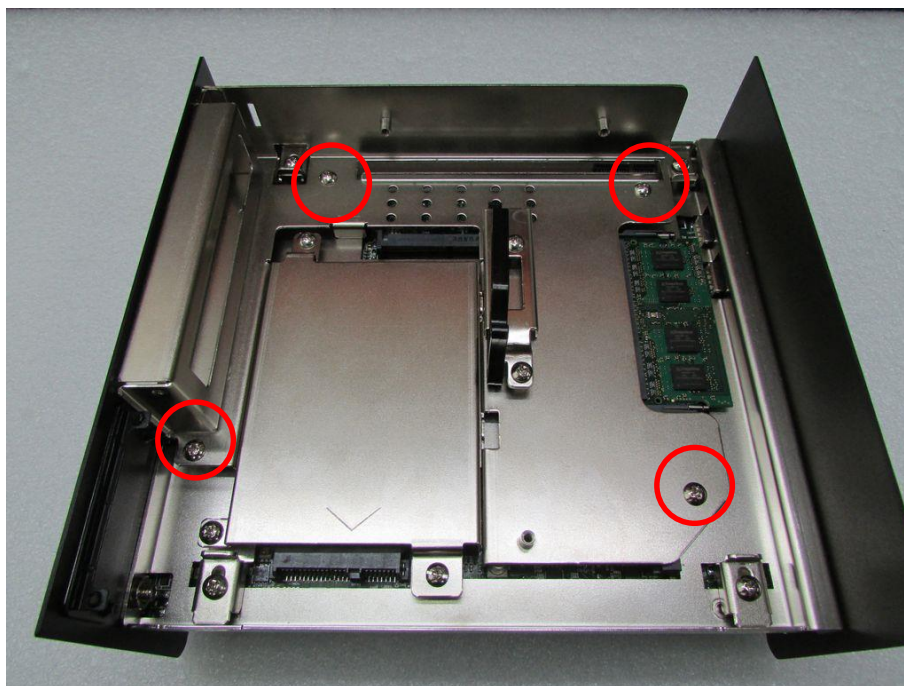

2. Locate SO-DIMM socket on the bottom.

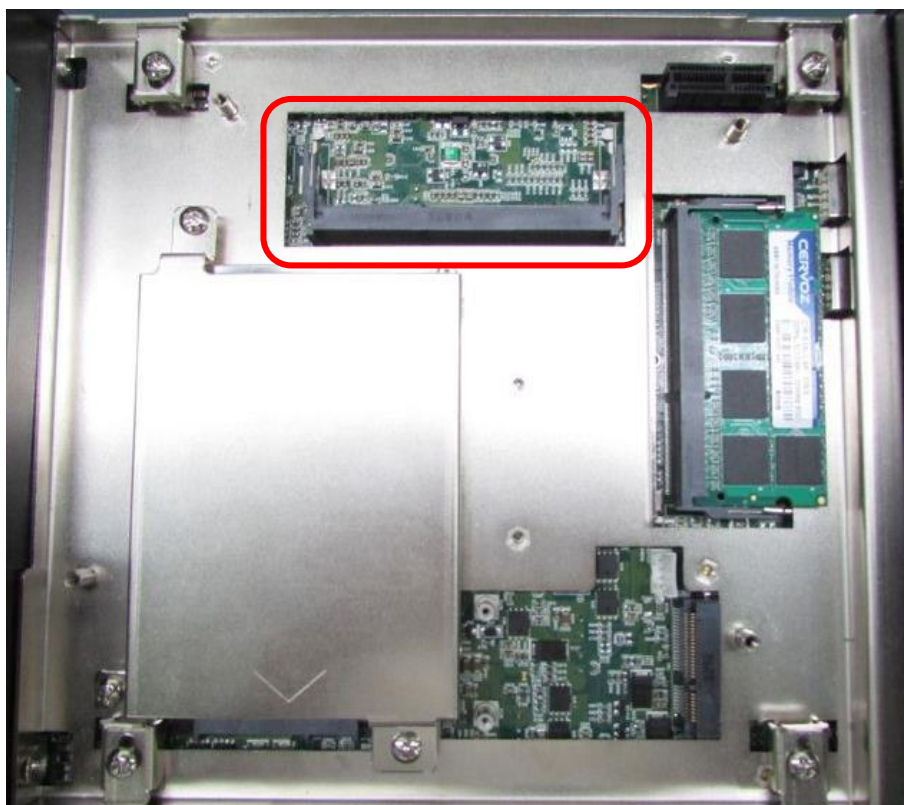

3. Tilt the SO-DIMM module at 45 degree angle and insert it to SO-DIMM socket. Be sure the gold-plated connects to SO-DIMM socket firmly.



4. Press the module down and it's fixed firmly by the two locking latches on each side.

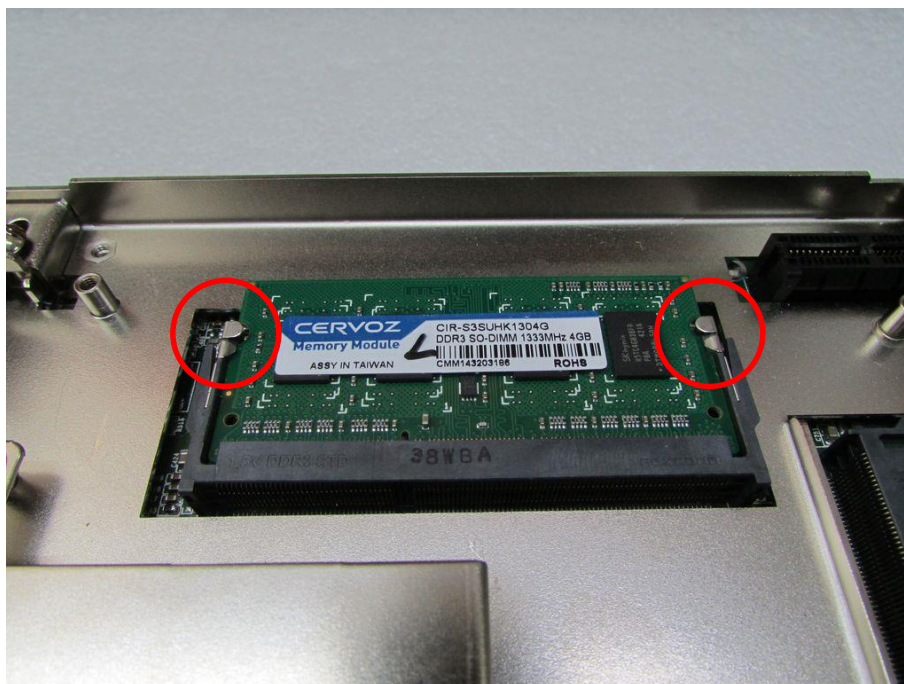

5. Place the expansion module back to chassis and fasten it with screws afterwards.

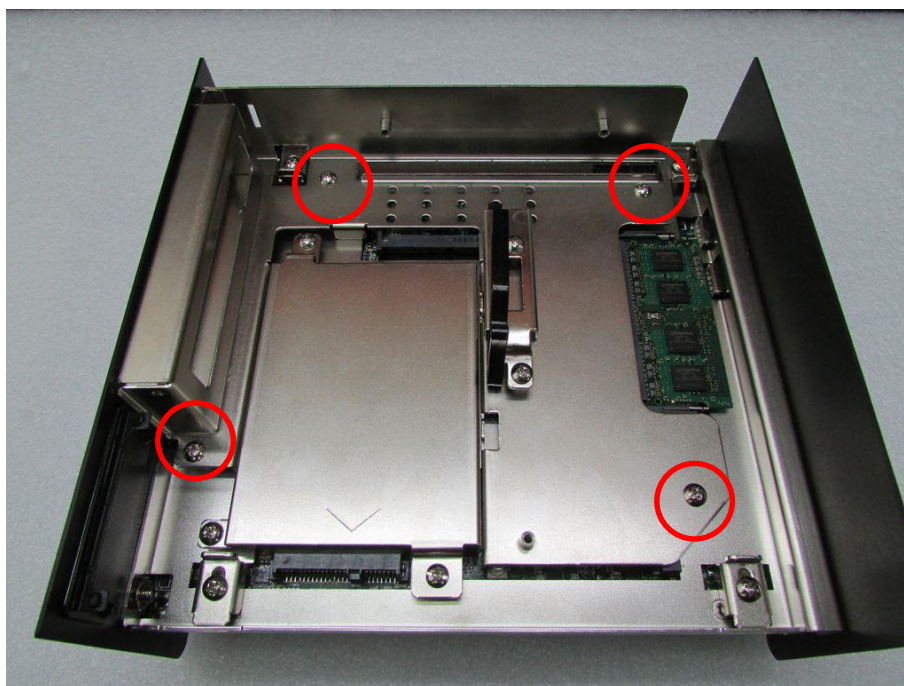

3.10 Installing Half Size Mini PCIe Card on Bottom Side

1. Flip over the body unit and locate Mini PCIe or mSATA slot on the bottom side. Loosen screws and take expansion module out of system gently.

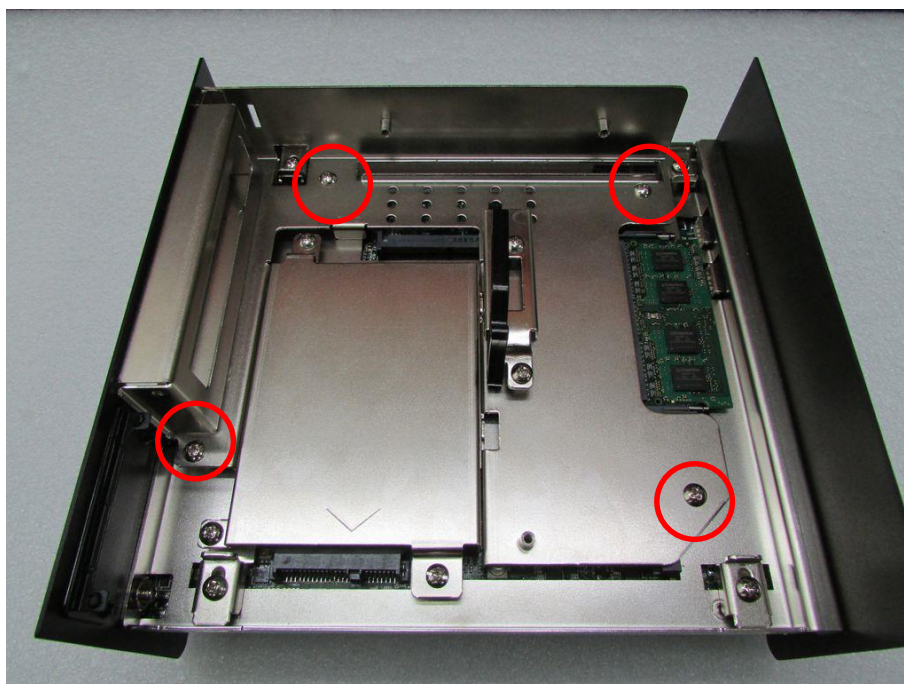

2. Locate the Mini PCIe slot.

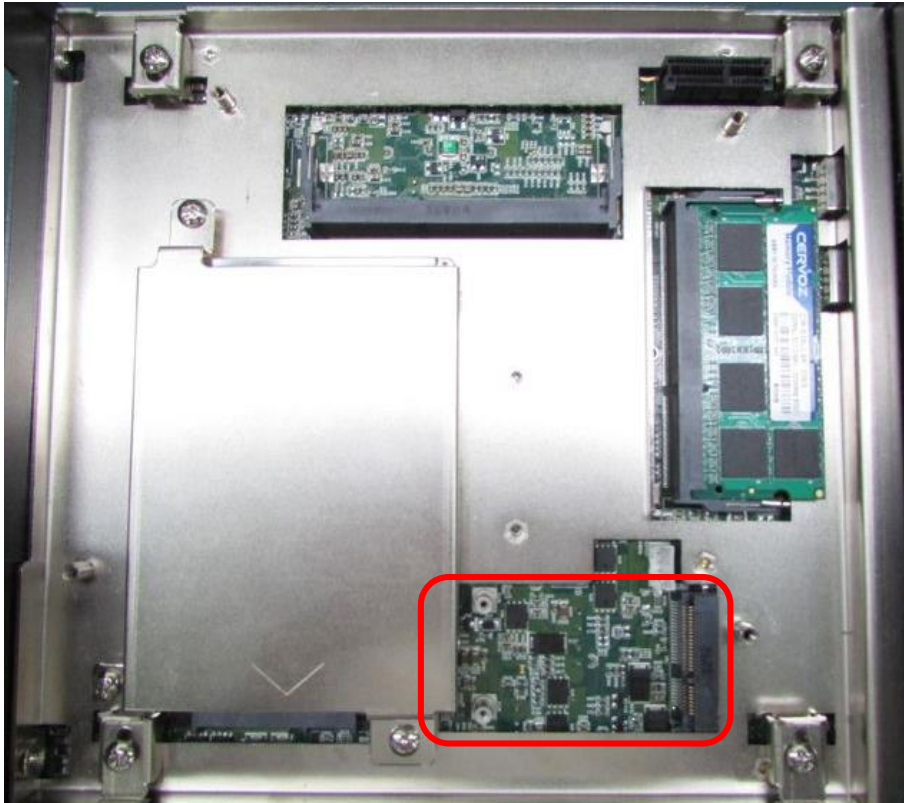

3. Fasten the module and bracket together with 2 screws.



4. Tilt the Mini PCIe module at 45 degree angle and insert it to Mini PCIe slot . Be sure the gold-plated connects to the Mini PCIe slot firmly.



5. Press down the module and use previous two screws to fix the module.

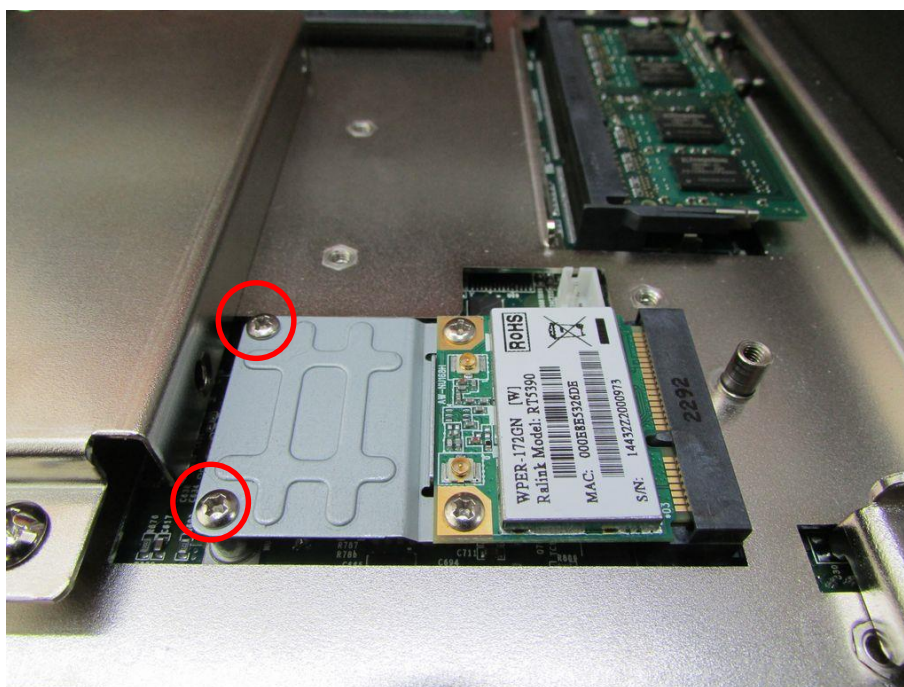

6. Place the expansion module back to chassis and fasten the screws afterwards.

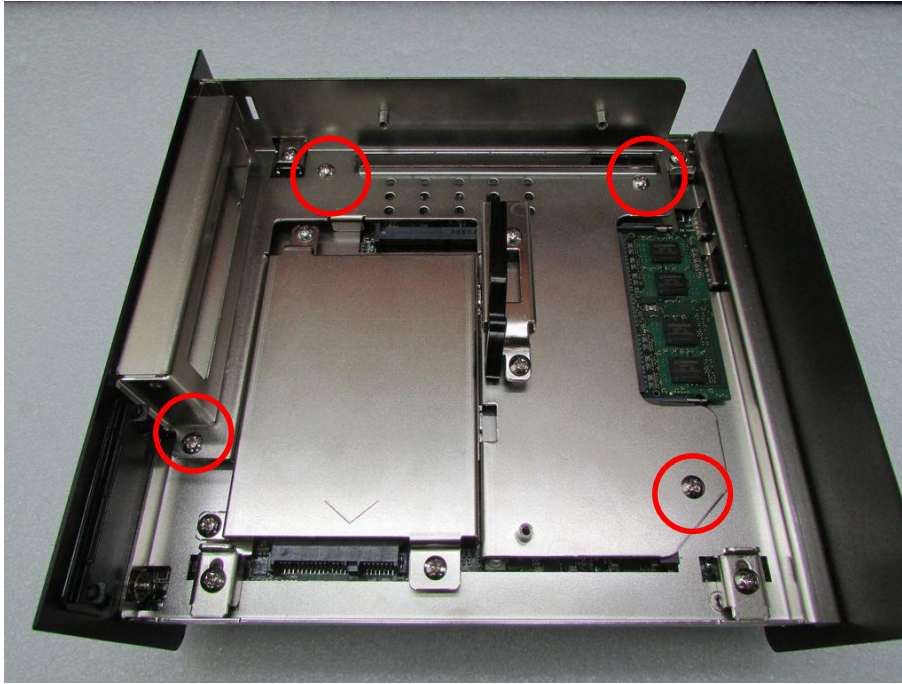

3.11 Installing Full Size Mini PCIe Cards on Bottom Side

1. Flip over the body unit and locate Mini PCIe or mSATA slot on the bottom. Loosen screws and take expansion module out of system.

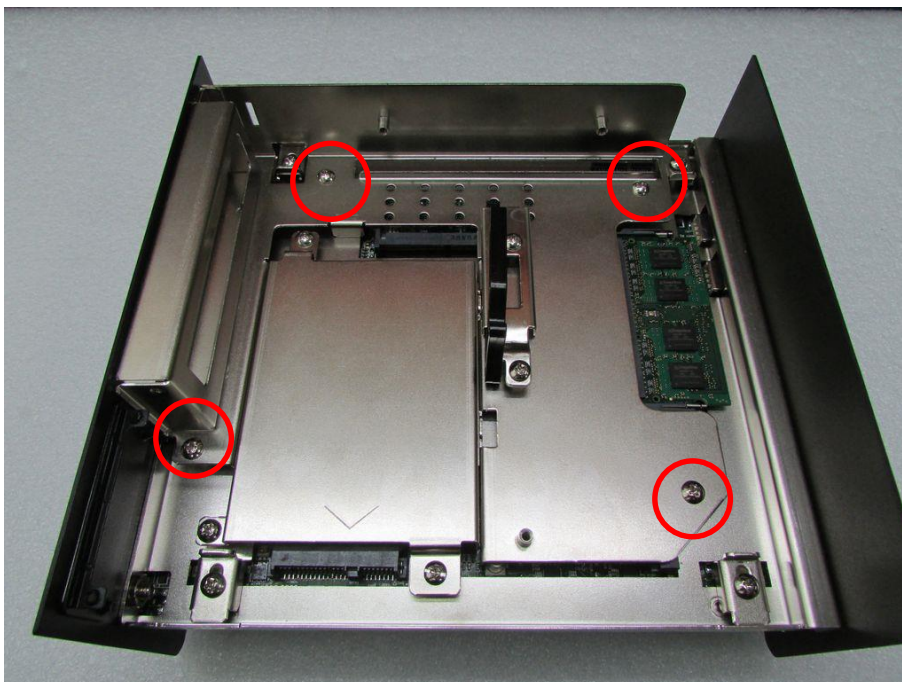

2. Locate the Mini PCIe slot.

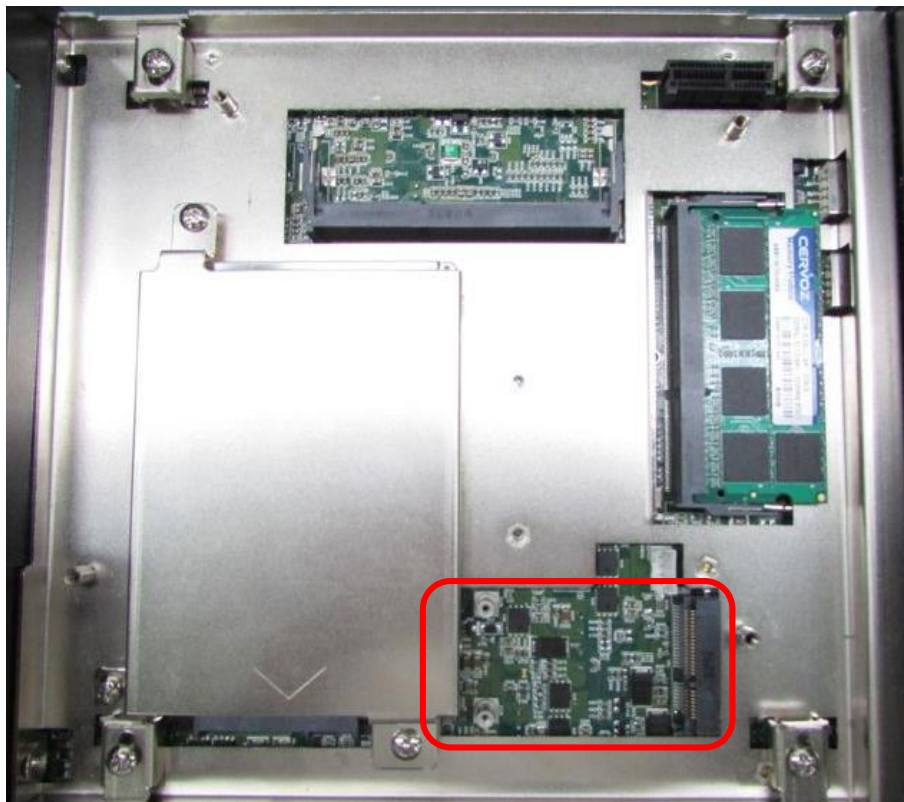

3. Tilt the Mini PCIe or mSATA module at 45 degree angle and insert it to Mini PCIe slot. Be sure the gold-plated connects to the Mini PCIe slot firmly.

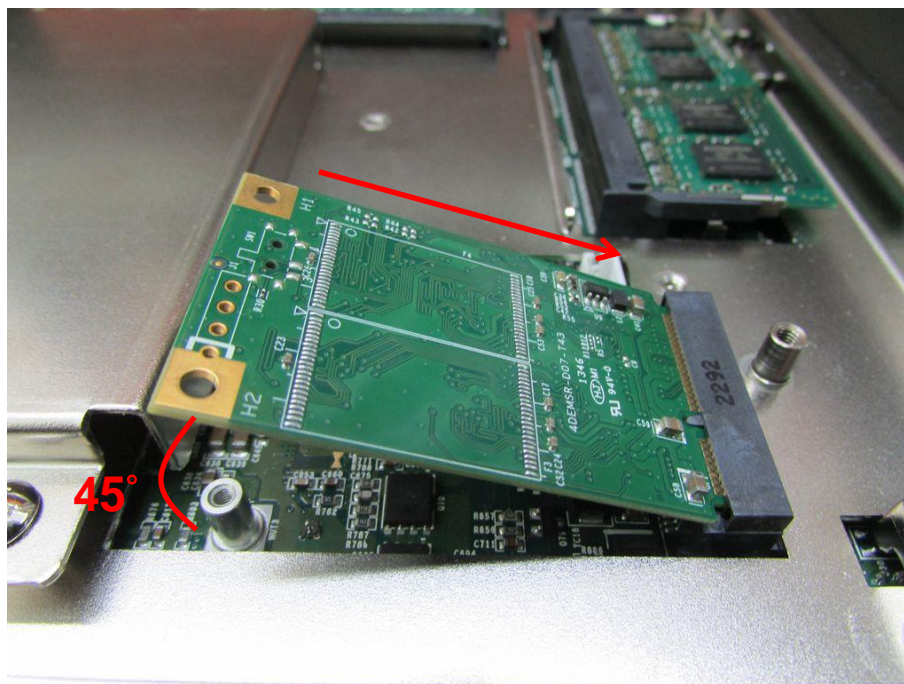

4. Press down the module and use previous two screws to fix the module.

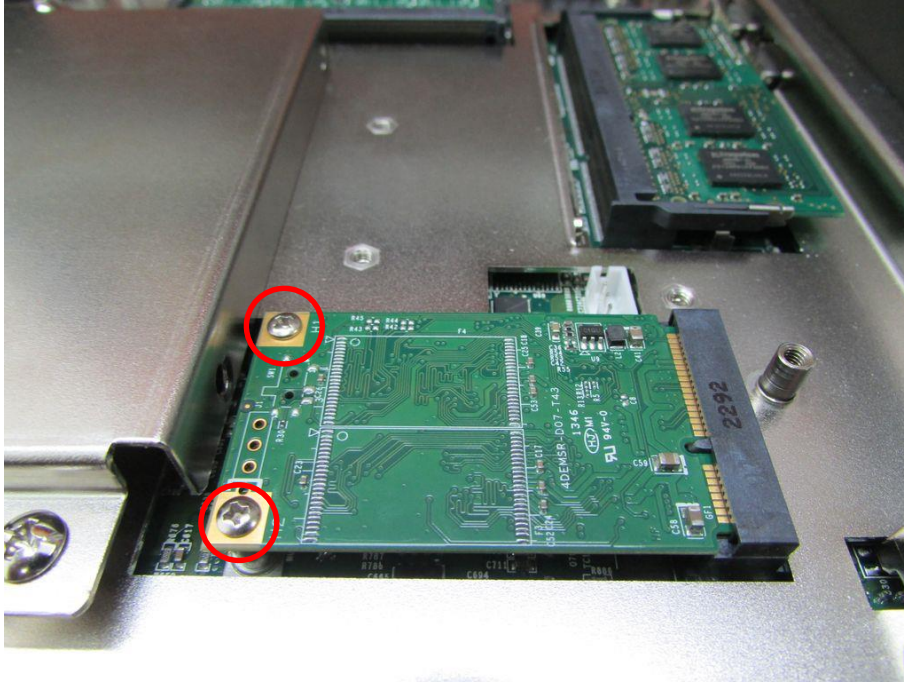

5. Place the expansion module back to chassis and fasten the screws afterwards.

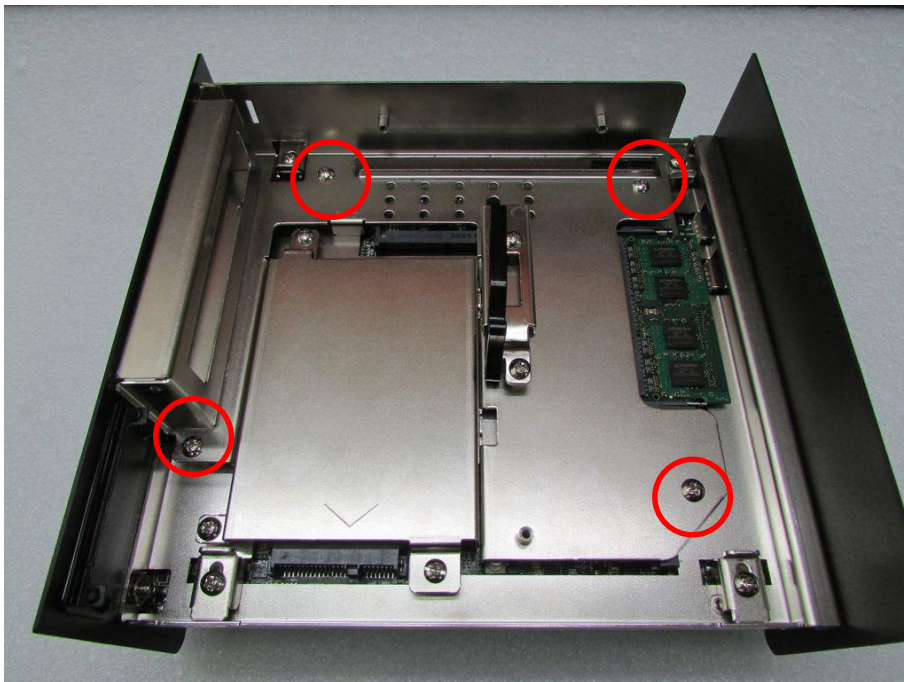

3.12 Installing the PCI/PCle Cards on Expansion Module (DE-1001 and DE-1002 Only)

1. Locate the PCI/ PCIe expansion module, loosen screws , and take expansion module out of system (Take DE-1001 for example).

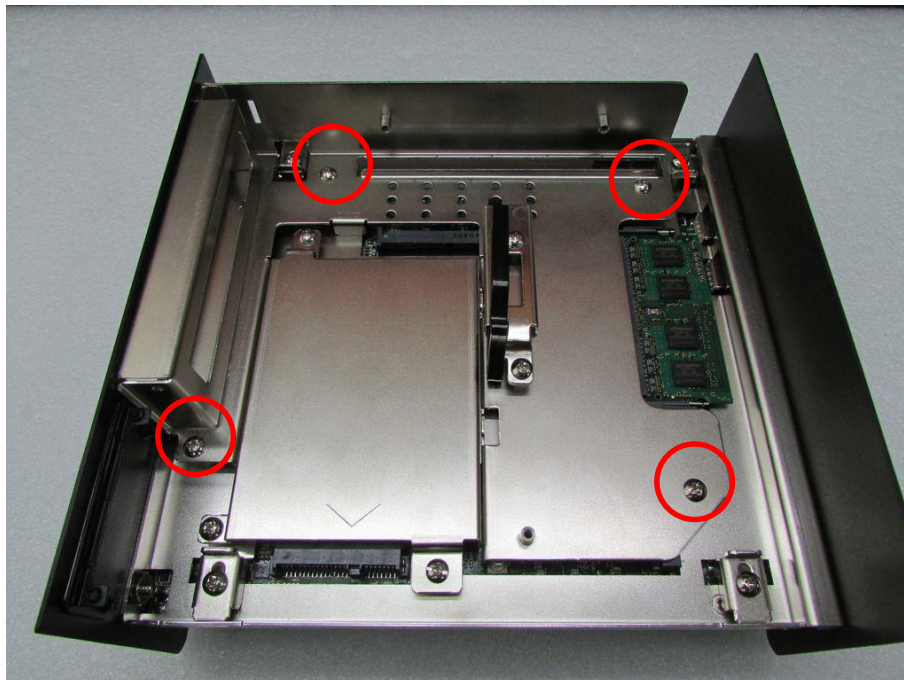

2. Loosen the screw on PCI bracket to remove the bracket.

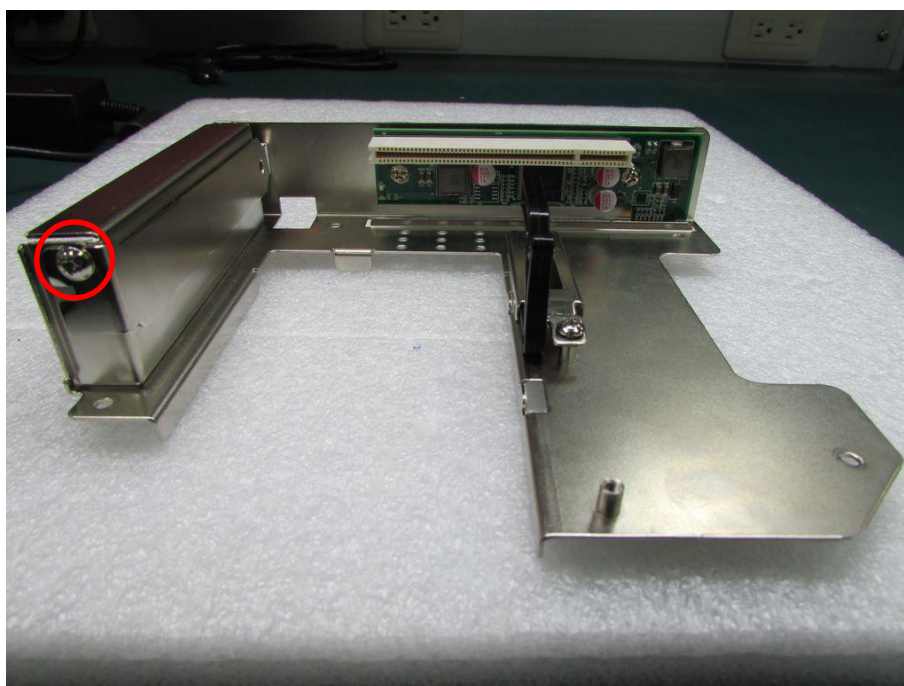

3. Loosen the screw to remove the card retainer .

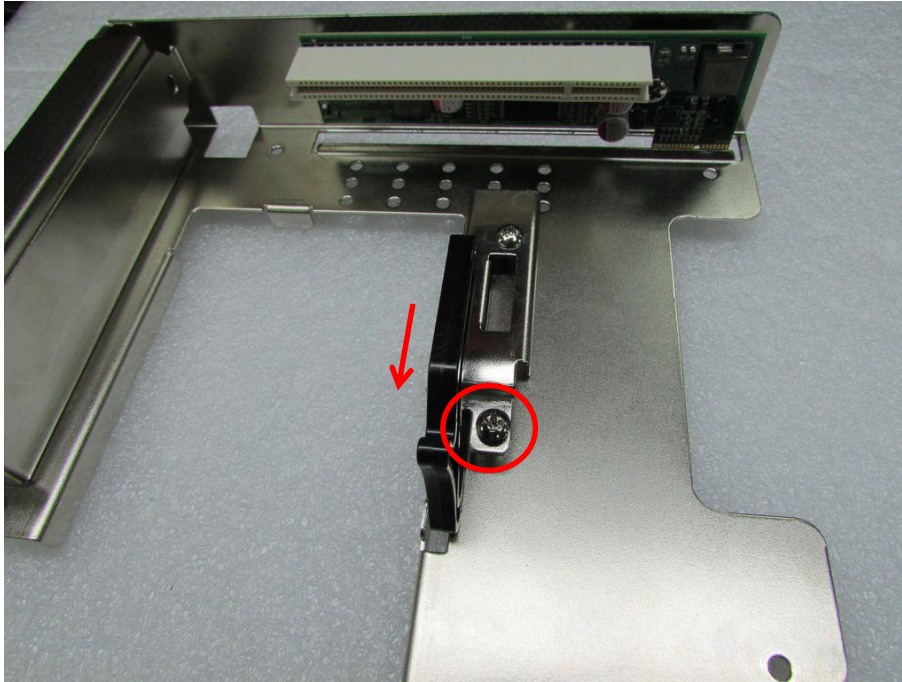

4. Please check the following photos for instruction of placing expansion module. Insert the PCI or PCIe card to the slot and fasten the screw on PCI bracket.

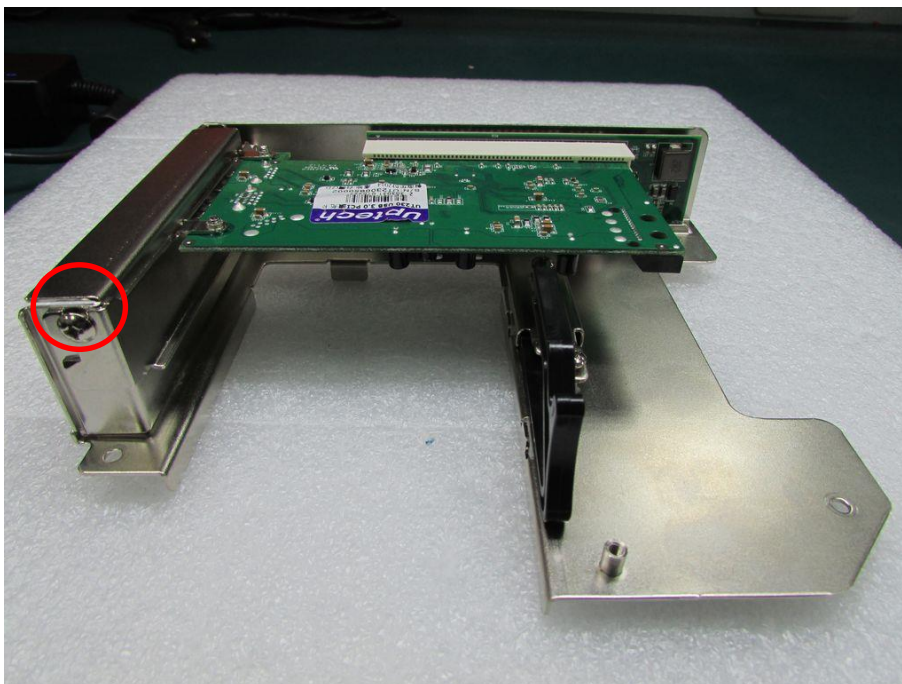

5. Before fastening the screw, you need to have the edge of PCI or PCIe module in the grooves properly. Be sure the card retainer holds the expansion module firmly.

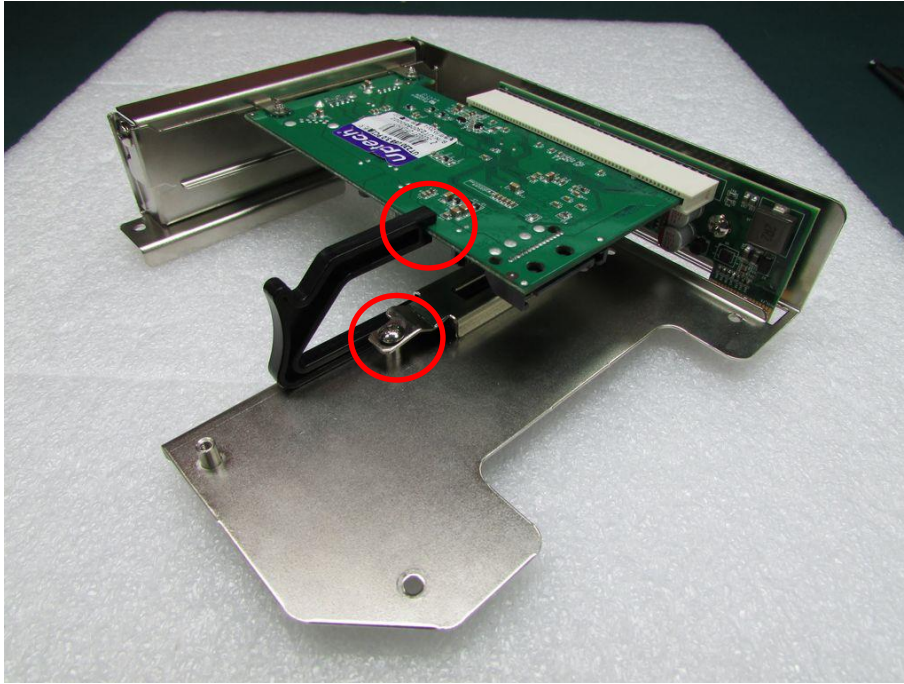

6. Place the expansion module back to chassis and fasten the screws afterwards.

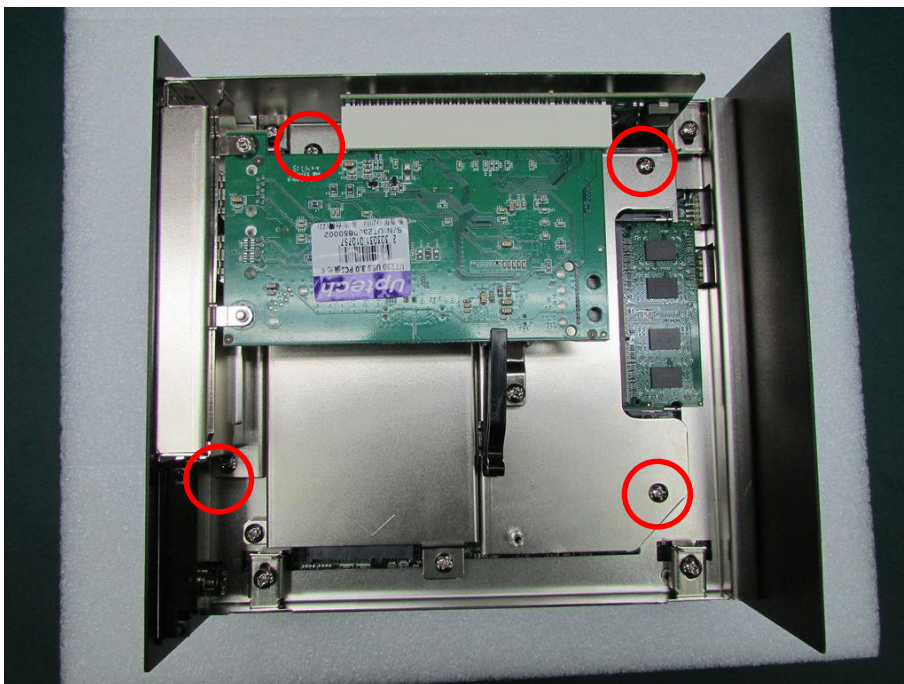

3.13 Installing the Chassis

1. Be sure to align the grooves with front and rear panels. Put the cover back on and fasten the screws to fix the cover.

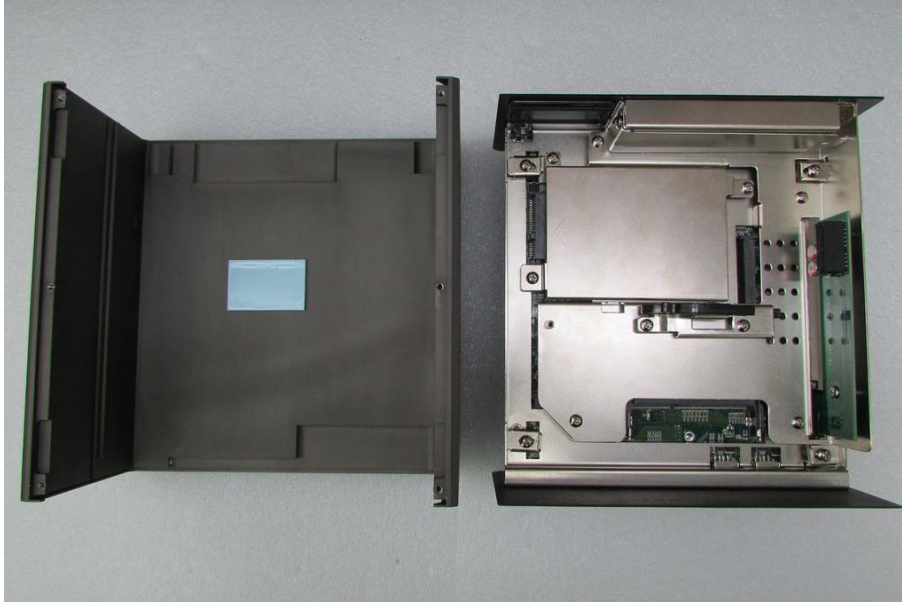

2. When place back the body of unit, you need to have 4 pieces of base holders and edges of front and rear panels are in the chassis grooves in order to assemble the body onto chassis firmly. Fasten the base holders with 4 screws afterwards.

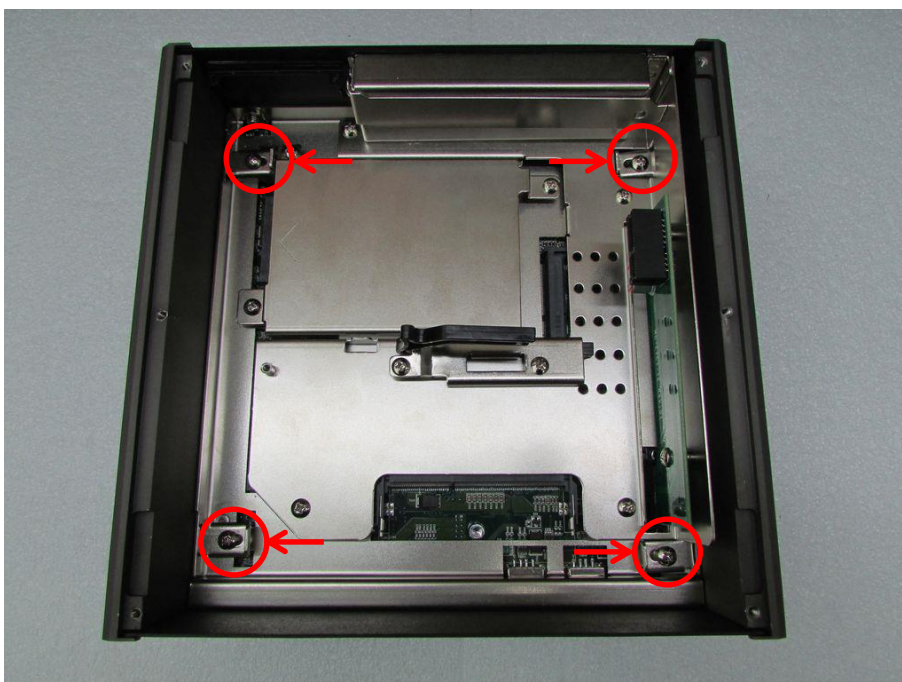

3.14 Installing the Chassis Bottom Cover

1. Be sure to align the grooves with front and rear panels. Have the bottom cover back on the system and fasten the screws to fix the cover.

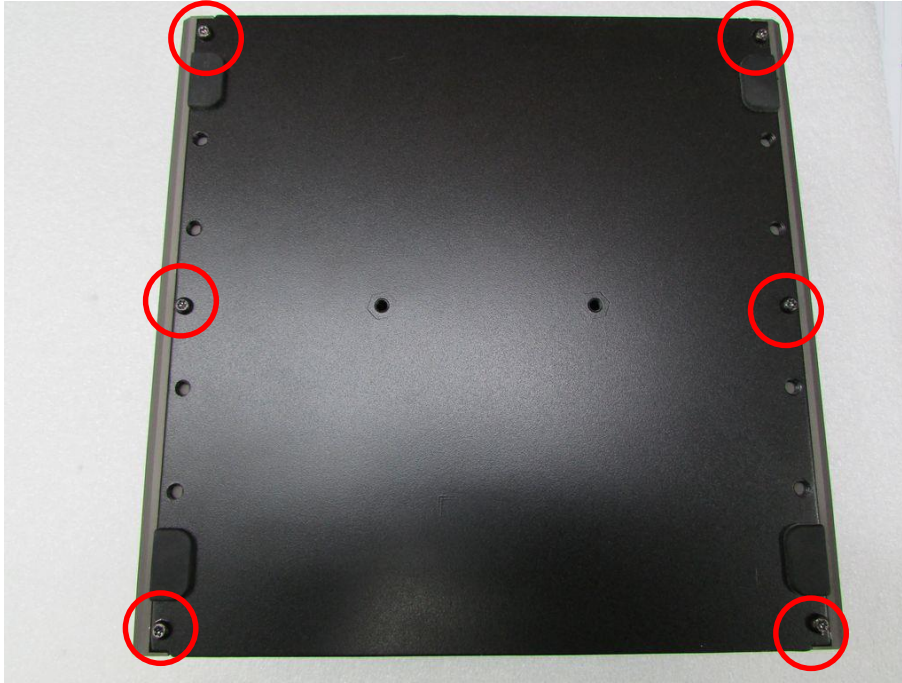

3.15 Installing a SIM Card

1. Loosen the screws in order to remove the expansion plate in the front.



2. Locate the SIM card slot to insert SIM card (according to the icon instruction aside).

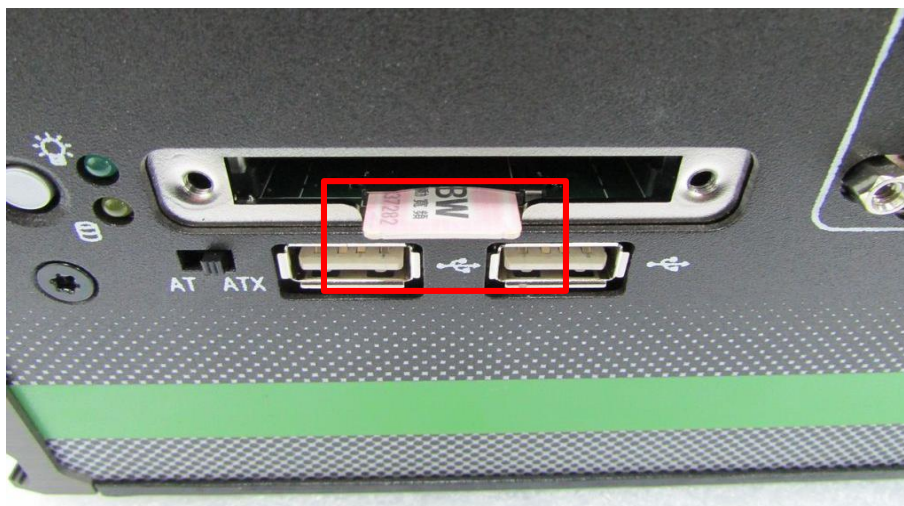

3. Fasten the cover back on by using 2 screws.



3.16 Installing a CFast Card

1. Loosen the screws in order to remove the expansion plate in the front.



2. Locate the CFast card slot to insert the CFast card.

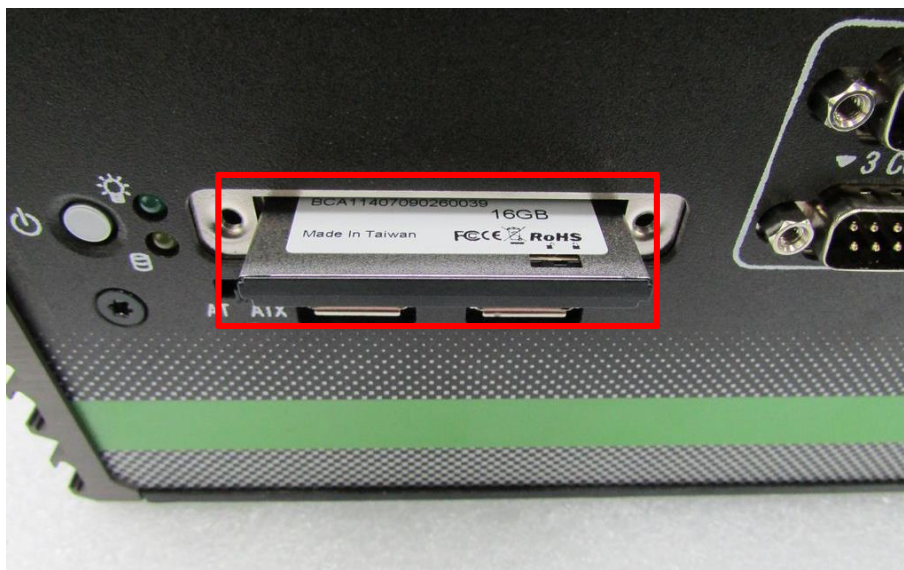

3. Fasten the cover back on by using 2 screws.



3.17 Wall Mount Bracket

DE-1000 series offers wall mount that customers can install system on the wall in convenient and economical ways.



1. The mounting holes are on the bottom of system. Use provided 8 screws to fasten the brackets on each side of the system.

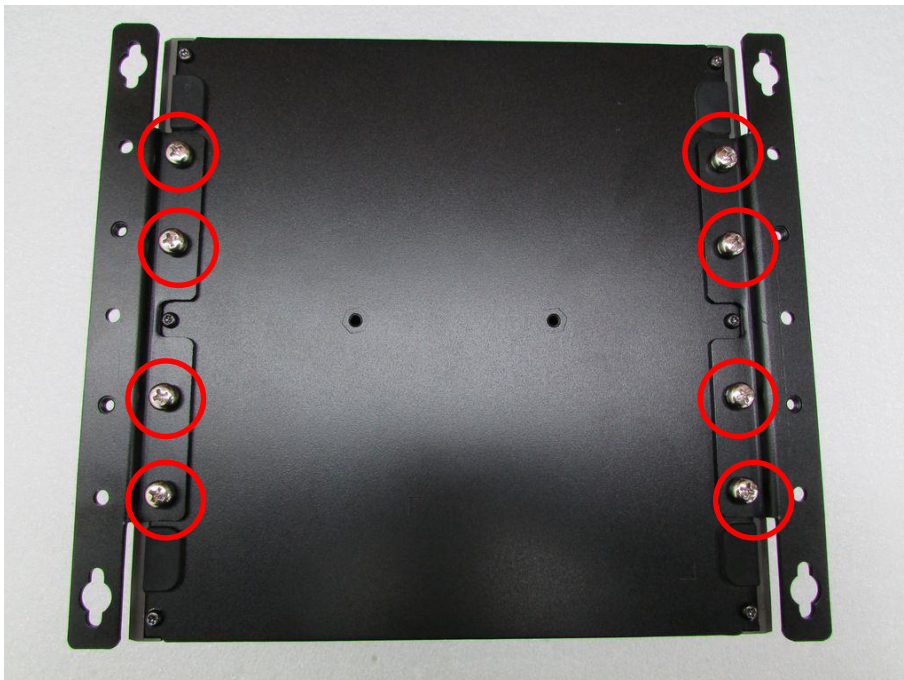

2. Fasten the screws through the mounting hole to mount system on the wall.

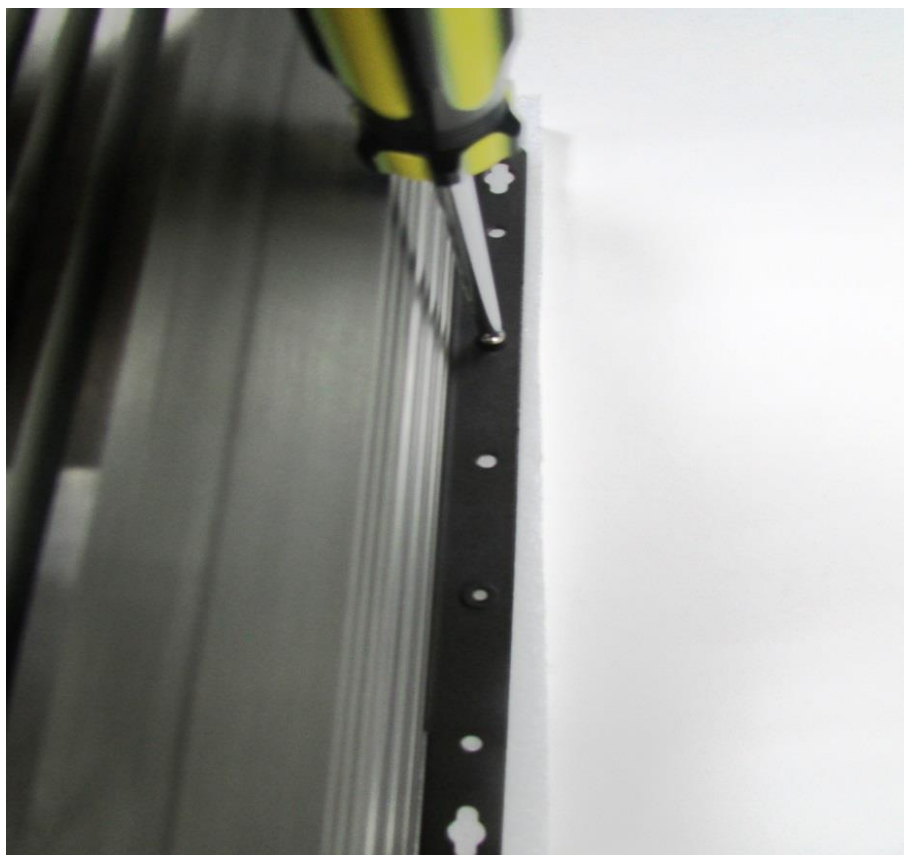



Chapter 4

BIOS Setup

4.1 BIOS Introduction

The BIOS (Basic Input/Output System) is a program located on a Flash Memory on the motherboard. When you start the computer, the BIOS program will gain control. The BIOS first operates an auto-diagnostic test called POST (power on self test) for all the necessary hardware, it detects the entire hardware device and configures the parameters of the hardware synchronization.

BIOS Setup

Power on the computer and by pressing immediately allows you to enter Setup. If the message disappears before your respond and you still wish to enter Setup, restart the system to try again by turning it OFF then ON or pressing <Ctrl>, <Alt> and <Delete> keys.

Control Keys	
<←> <→>	Move to select screen
<↑> <↓>	Move to select item
<Esc>	Quit the BIOS Setup
<Enter>	Select item
<Page Up/+>	Increases the numeric value or makes changes
<Page Down/->	Decreases the numeric value or makes changes
<Tab>	Select setup fields
<F1>	General help
<F2>	Previous value
<F3>	Load Optimized defaults
<F10>	Save configuration and Exit

Main Menu

The main menu lists the setup functions you can make changes to. You can use the arrow keys (↑↓) to select the item. The on-line description of the highlighted setup function is displayed at the bottom of the screen.

Sub-Menu

If you find a right pointer symbol appears to the left of certain fields that means a sub-menu can be launched from this field. A sub-menu contains additional options for a field parameter. You can use arrow keys (↑↓) to highlight the field and press <Enter> to call up the sub-menu. Then you can use the control keys to enter values and move from field to field within a sub-menu. If you want to return to the main menu, just press the <Esc >.

4.2 Main Setup

Press to enter BIOS CMOS Setup Utility, the Main Menu (as shown below) will appear on the screen. Use arrow keys to move among the items and press <Enter> to accept or enter a sub-menu.

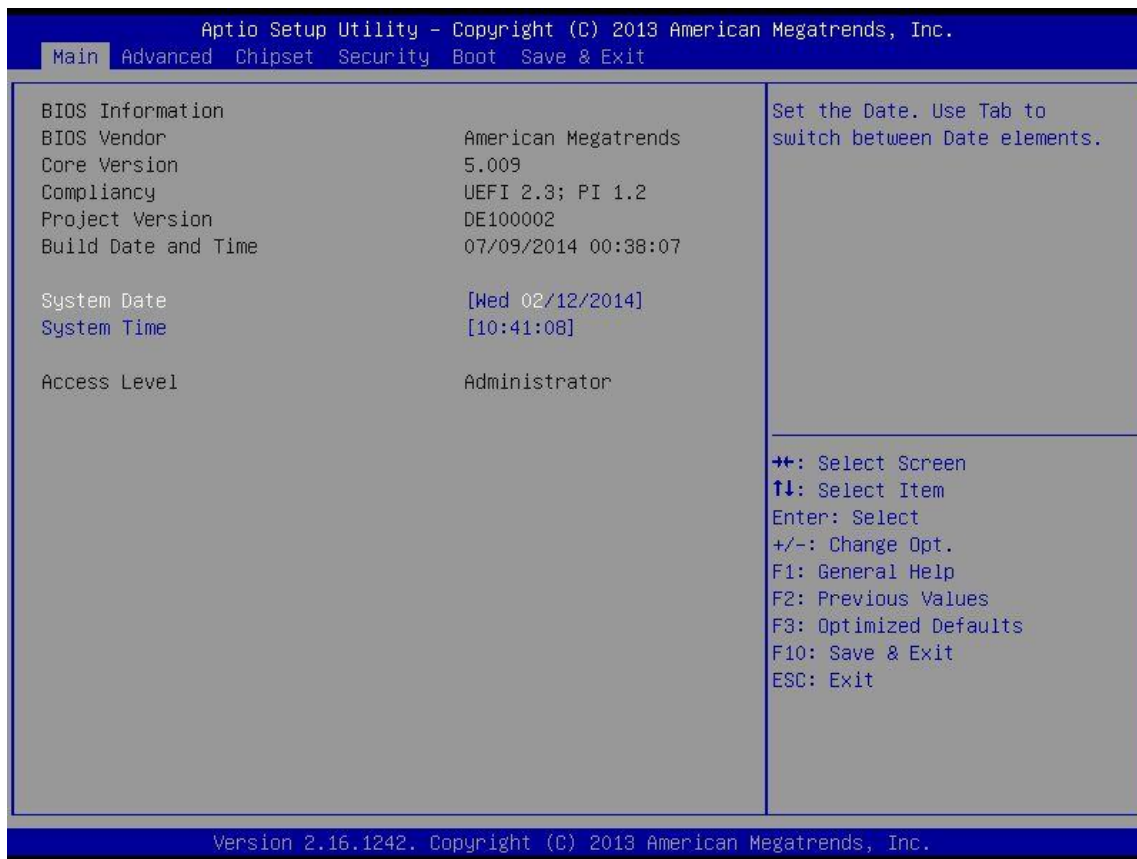

4.2.1 System Date

Set the date. Please use <Tab> to switch between data elements.

4.2.2 System Time

Set the time. Please use <Tab> to switch between time elements.

4.3 Advanced Setup

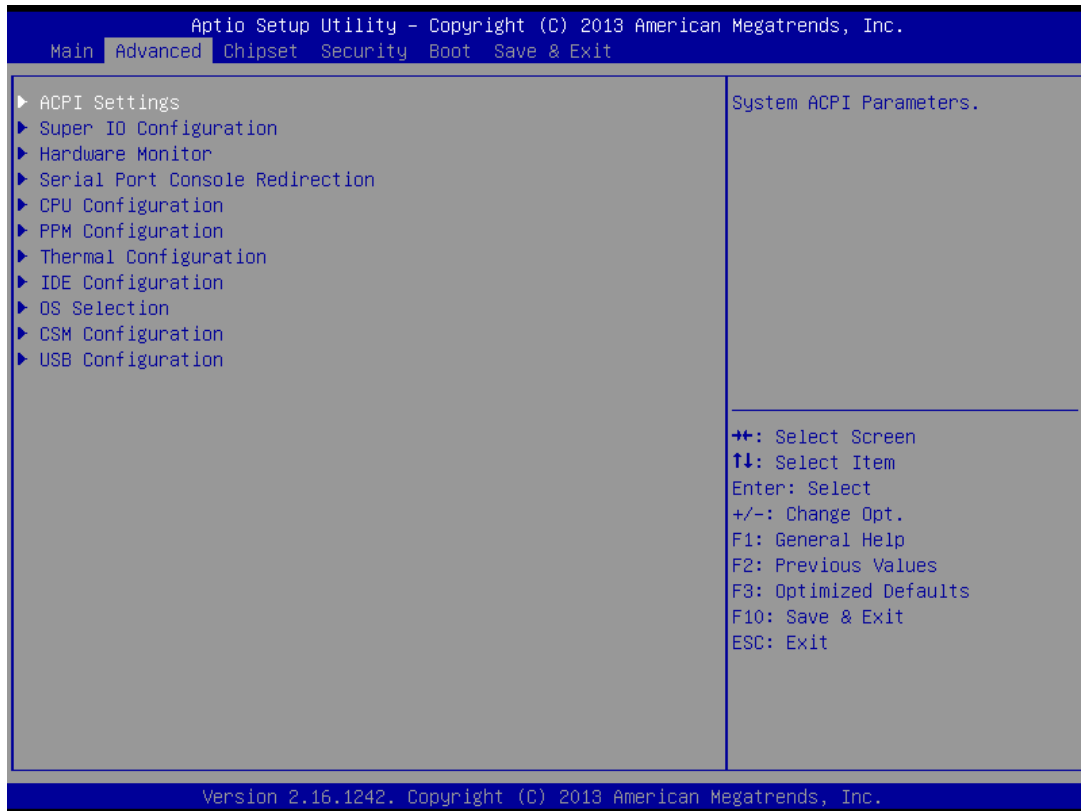

4.3.1 ACPI Settings

Enable or disable BIOS ACPI Auto Configuration.

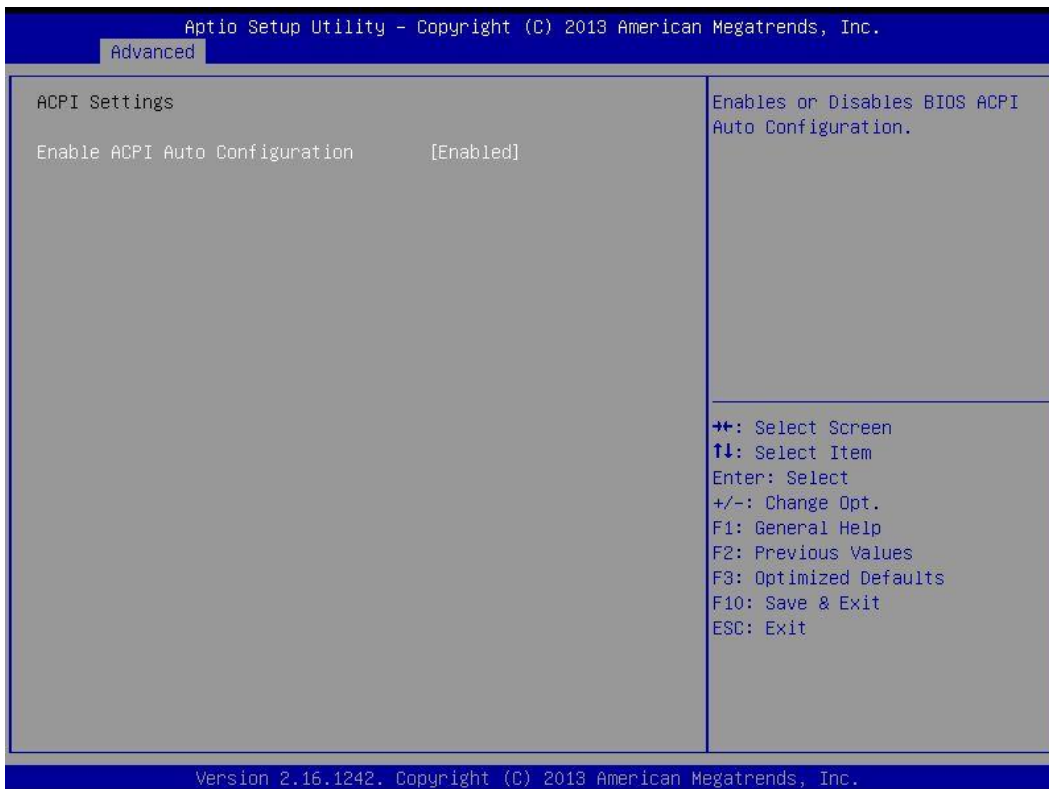

4.3.2 Super IO Configuration

You can use this screen to select options for the Super IO Configuration, and change the value of the selected option.

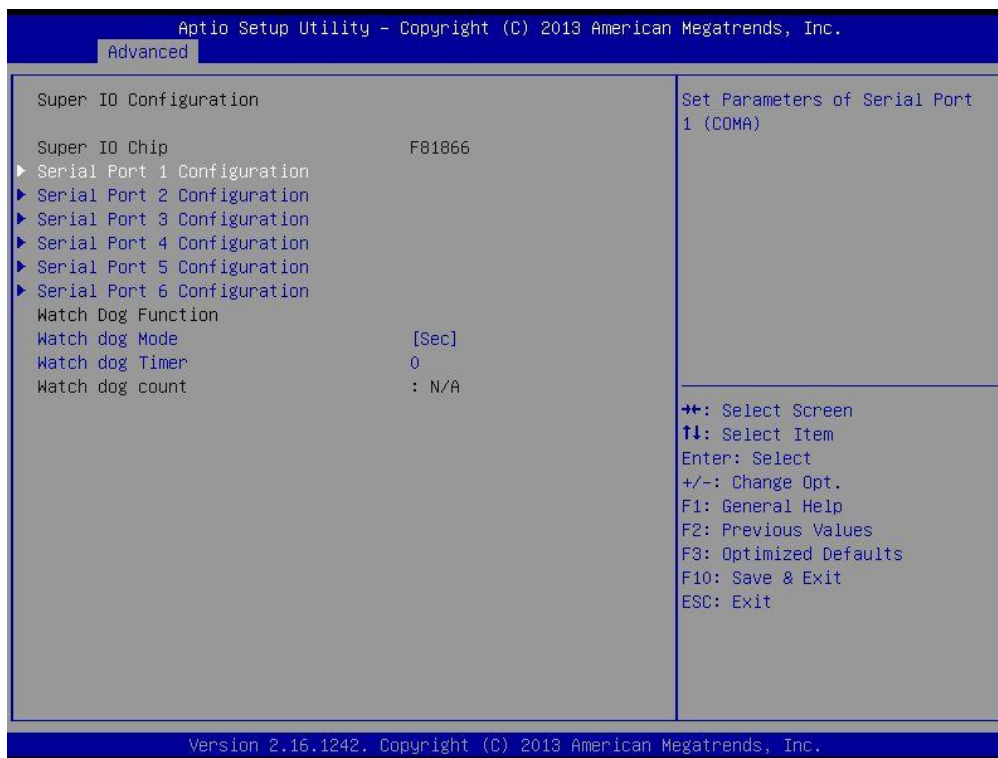

Serial Port 1 Configuration

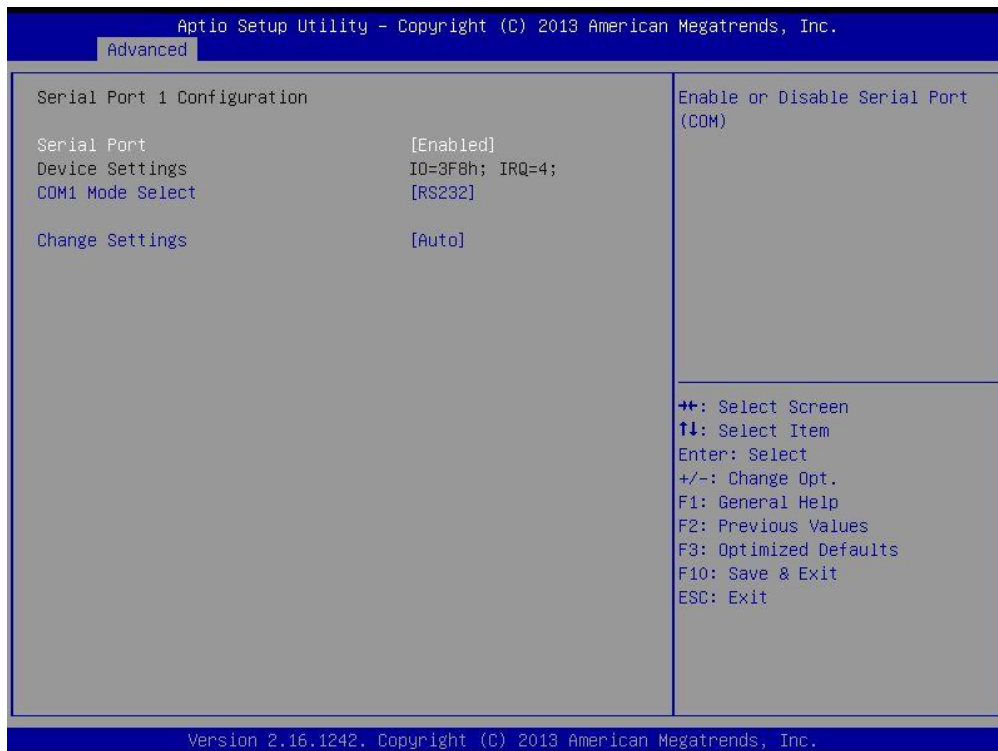

Serial Port

This item will allow users to enable or disable serial port.

COM1 Mode Select

Change the Serial interface. Select <RS232> ,<RS422> or <RS485> interface.

Change Settings

This setting is used to change the address & IRQ settings of the specified serial port.

Serial Port 2 Configuration

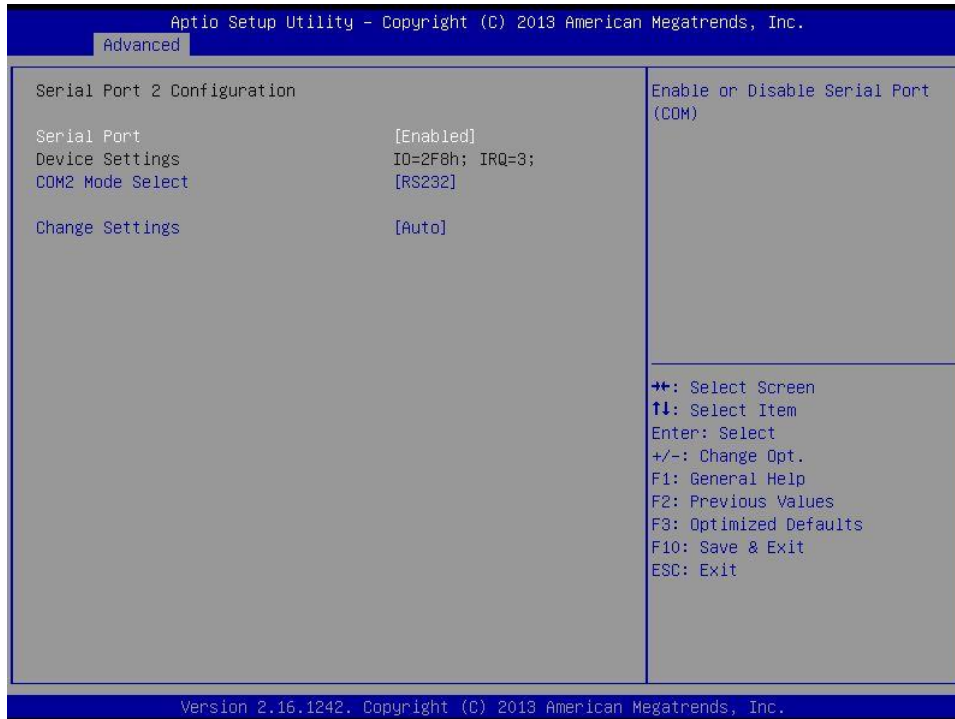

Serial Port

This item will allow users to enable or disable serial port.

COM2 Mode Select

Change the Serial interface. Select <RS232> ,<RS422> or <RS485> interface.

Change Settings

This setting is used to change the address & IRQ settings of the specified serial port.

Serial Port 3 Configuration

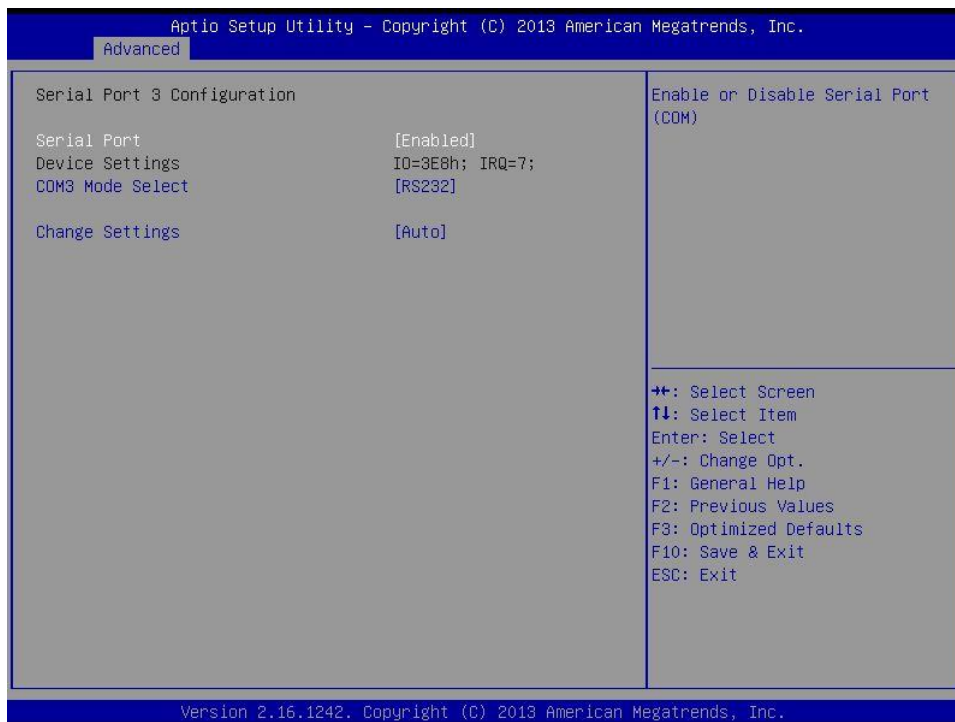

Serial Port

This item will allow users to enable or disable serial port.

COM3 Mode Select

Change the Serial interface. Select <RS232> ,<RS422> or <RS485> interface.

Change Settings

This setting is used to change the address & IRQ settings of the specified serial port.

Serial Port 4 Configuration

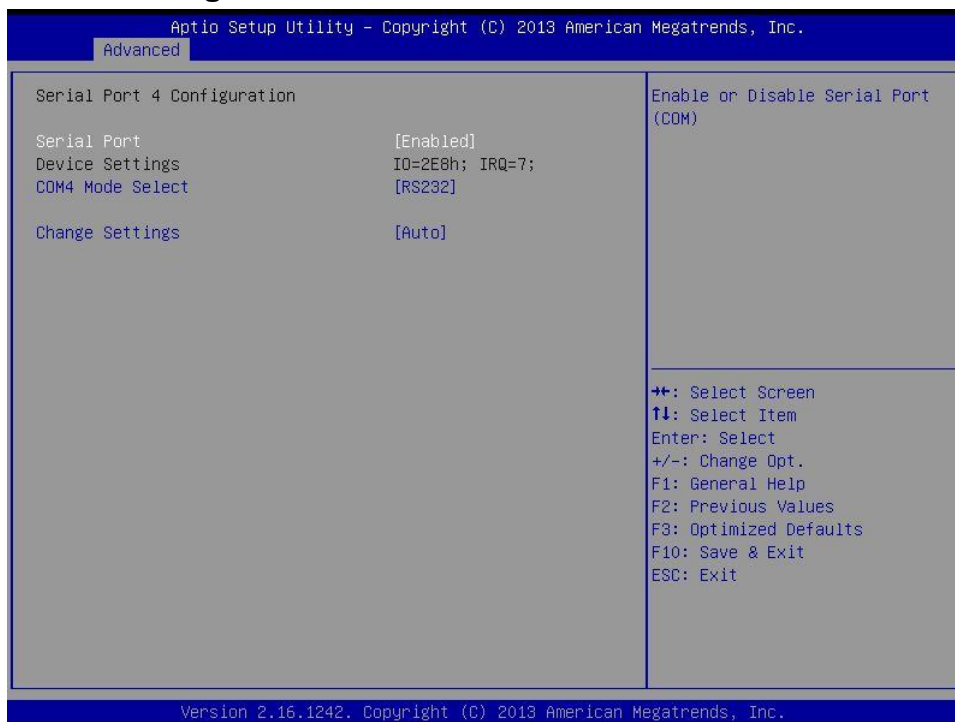

Serial Port

This item will allow users to enable or disable serial port.

COM4 Mode Select

Change the Serial interface. Select <RS232> ,<RS422> or <RS485> interface.

Change Settings

This setting is used to change the address & IRQ settings of the specified serial port.

Serial Port 5 Configuration

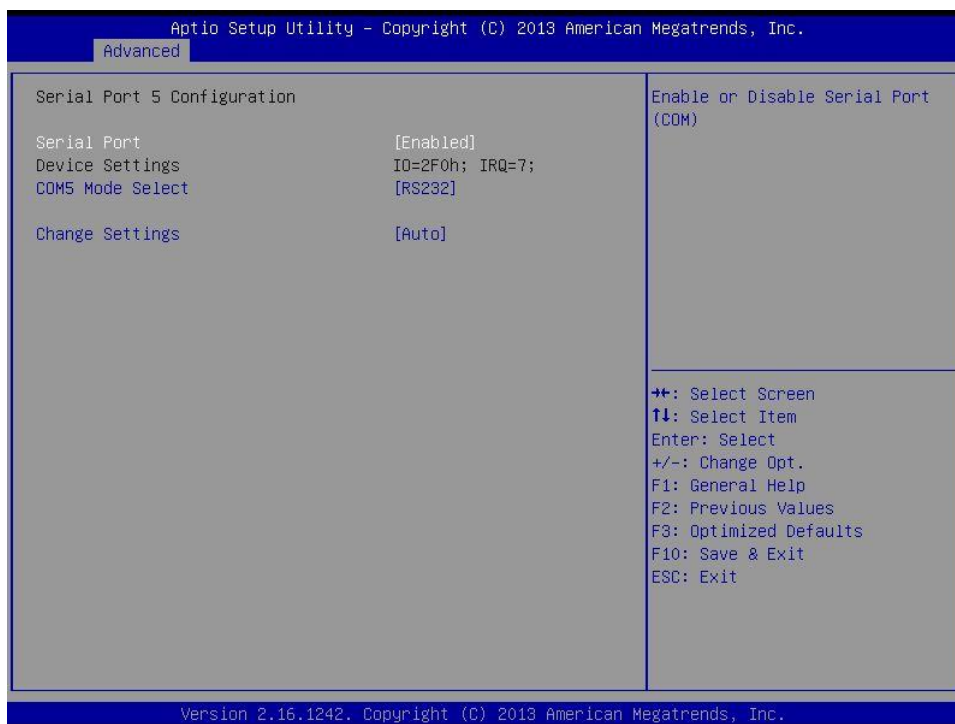

Serial Port

This item will allow users to enable or disable serial port.

COM5 Mode Select

Change the Serial interface. Select <RS232> ,<RS422> or <RS485> interface.

Change Settings

This setting is used to change the address & IRQ settings of the specified serial port.

Serial Port 6 Configuration

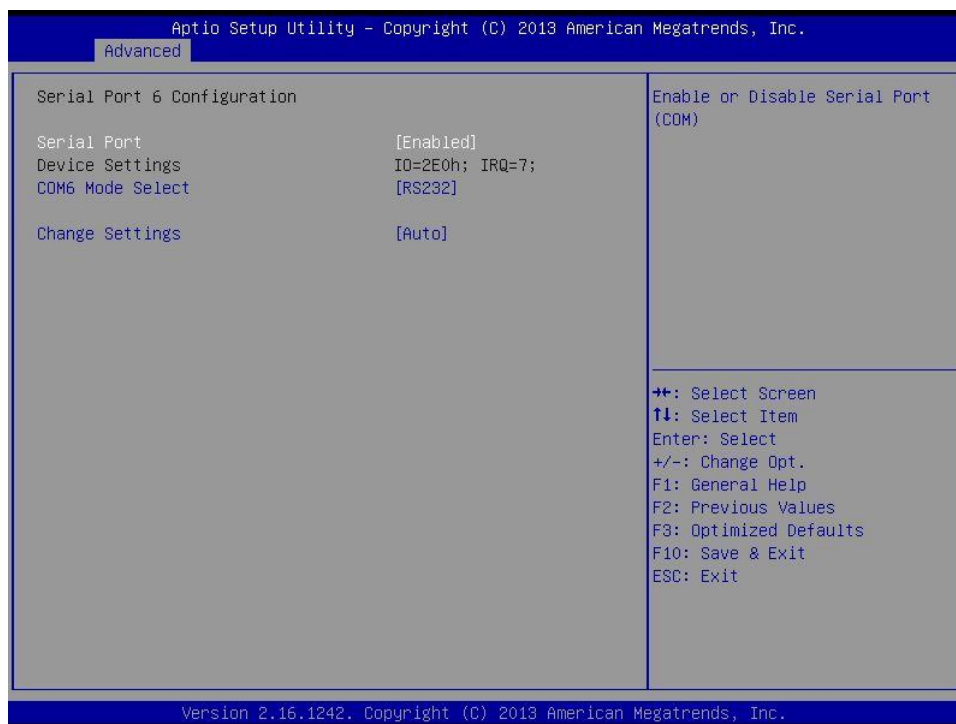

Serial Port

This item will allow users to enable or disable serial port.

COM6 Mode Select

Change the Serial interface. Select <RS232> ,<RS422> or <RS485> interface.

Change Settings

This setting is used to change the address & IRQ settings of the specified serial port.

Watch Dog Function

You can setup the system watch-dog timer, a hardware timer that generates a reset when the software that it monitors does not respond as expected each time the watch dog polls it.

Watch Dog Mode

Change the Watch dog mode. Select <Sec> or <Min> mode.

Watch Dog Timer

User can set a value in the range of 0 to 255.

4.3.3 Hardware Monitor

These items display the current status of all monitored hardware devices/ components such as voltages and temperatures.



■ PWM Fan Function

This item will allow users to enable or disable PWM Fan.

■ PWM Fan Mode Configuration

PWM Fan Duty

This item allows users to change the PWM Fan duty.

4.3.4 Serial Port Console Redirection

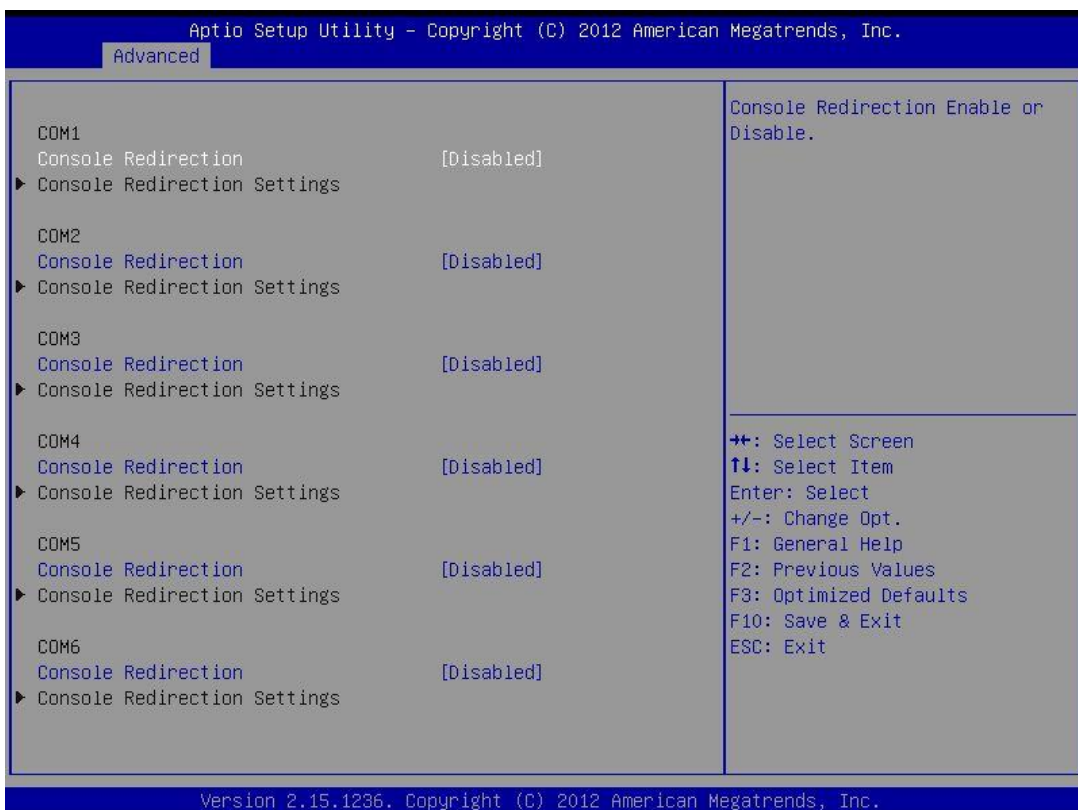

■ Console Redirection

This item allows users to enable or disable console redirection.

4.3.5 CPU Configuration

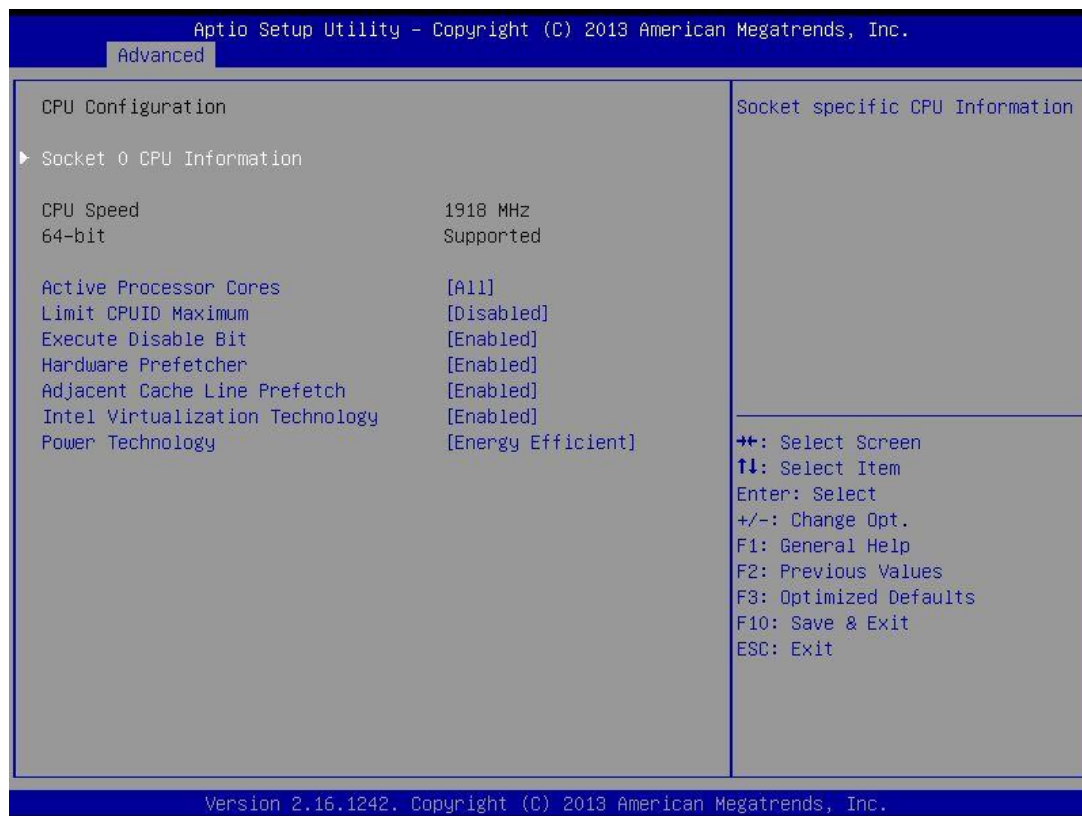

■ Socket 0 CPU Information

This section provides information on your CPU, frequency, and cache memory.

■ Active Processor Cores

Change the active processor cores. Select <All> or <1> mode.

■ Limit CPUID Maximum

Allows user to determine whether to limit CPUID maximum value. Set this item to Disabled: For Windows XP operating system.

Enabled: For legacy operating system such as Windows NT4.0. (Default: Disabled)

■ Execute Disable Bit

Enables or disables Intel Execute Disable Bit function.

■ Hardware Prefetcher

Enables or disables L2 Cache Hardware Prefetcher.

■ Adjacent Cache Line Prefetch

Enables or disables L2 prefetching of adjacent cache lines.

■ Intel Virtualization Technology

Enables or disables Intel Virtualization Technology. Virtualization enhanced by Intel Virtualization Technology will allow a platform to run multiple operating systems and applications in independent partitions. With virtualization, one computer system can function as multiple virtual systems.

■ Power Technology

Allows user to configure Intel power management features.

4.3.6 PPM Configuration

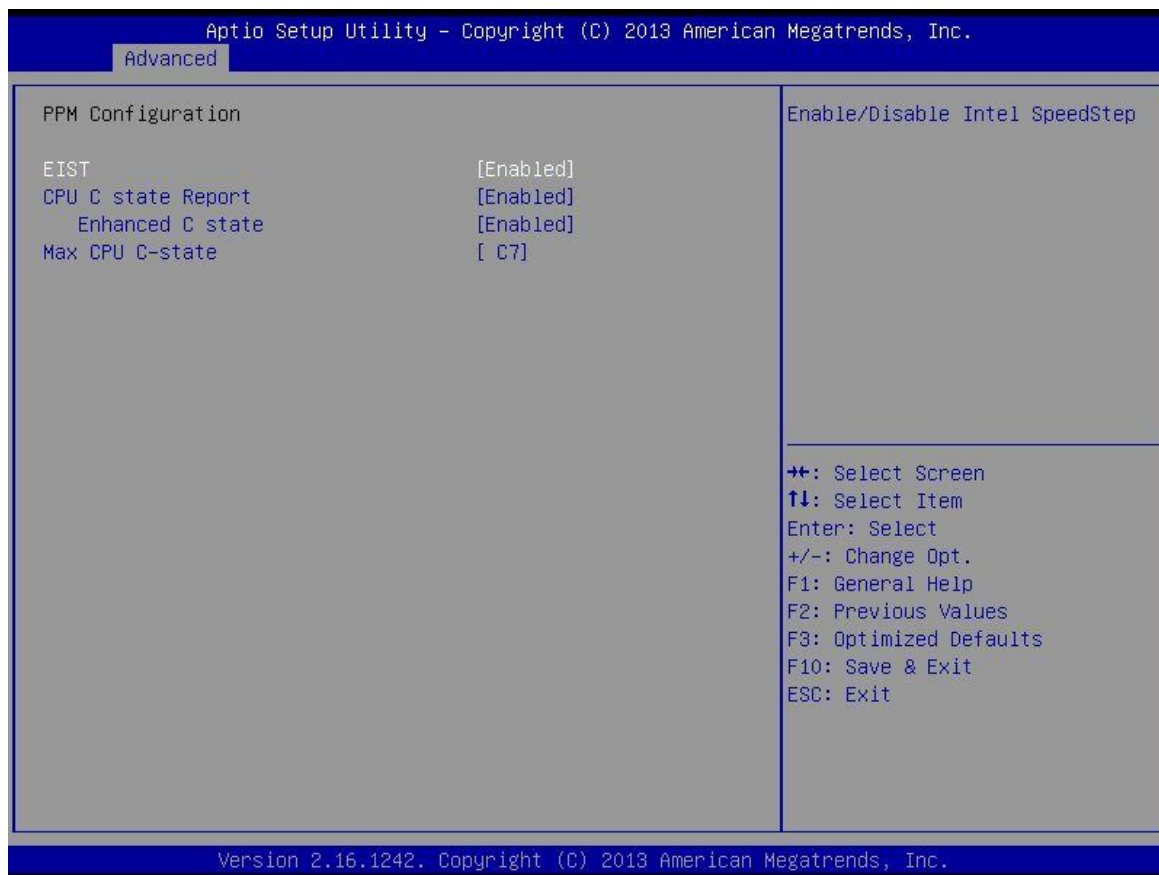

■ EIST

Enable or disable Intel SpeedStep.

■ CPU C state Report

Enables or disables support for CPU's power-saving functions.

■ Enhanced C state

Enables or disables Intel CPU Enhanced Halt (C1E) function, a CPU power-saving function in system halt state. When enabled, the CPU core frequency and voltage will be reduced during system halt state to decrease power consumption. This item is configurable only when CPU C state Report is enabled.

■ Max CPU C-state

Allows user to determine the maximum C state that the CPU will support.

4.3.7 Thermal Configuration

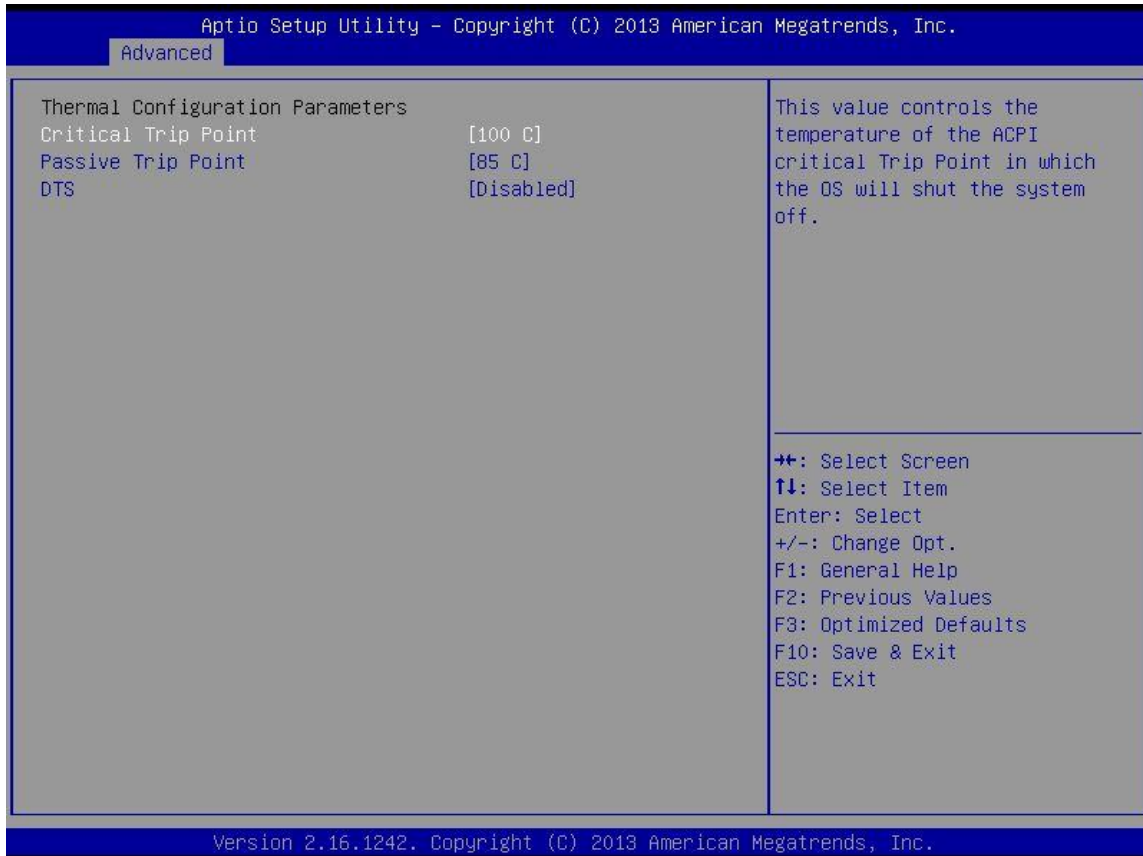

■ Critical Trip Point

Allows user to set the CPU temperature threshold. If the CPU temperature reaches this value, the operating system will shut down the system. This item is configurable only when DTS is enabled.

■ Passive Trip Point

Allows user to set the CPU temperature threshold. If the CPU temperature reaches this value, the CPU frequency will be automatically reduced. This item is configurable only when DTS is enabled.

■ DTS

Enables or disables the CPU overheating protection function. (Default: Disabled)

4.3.8 IDE Configuration

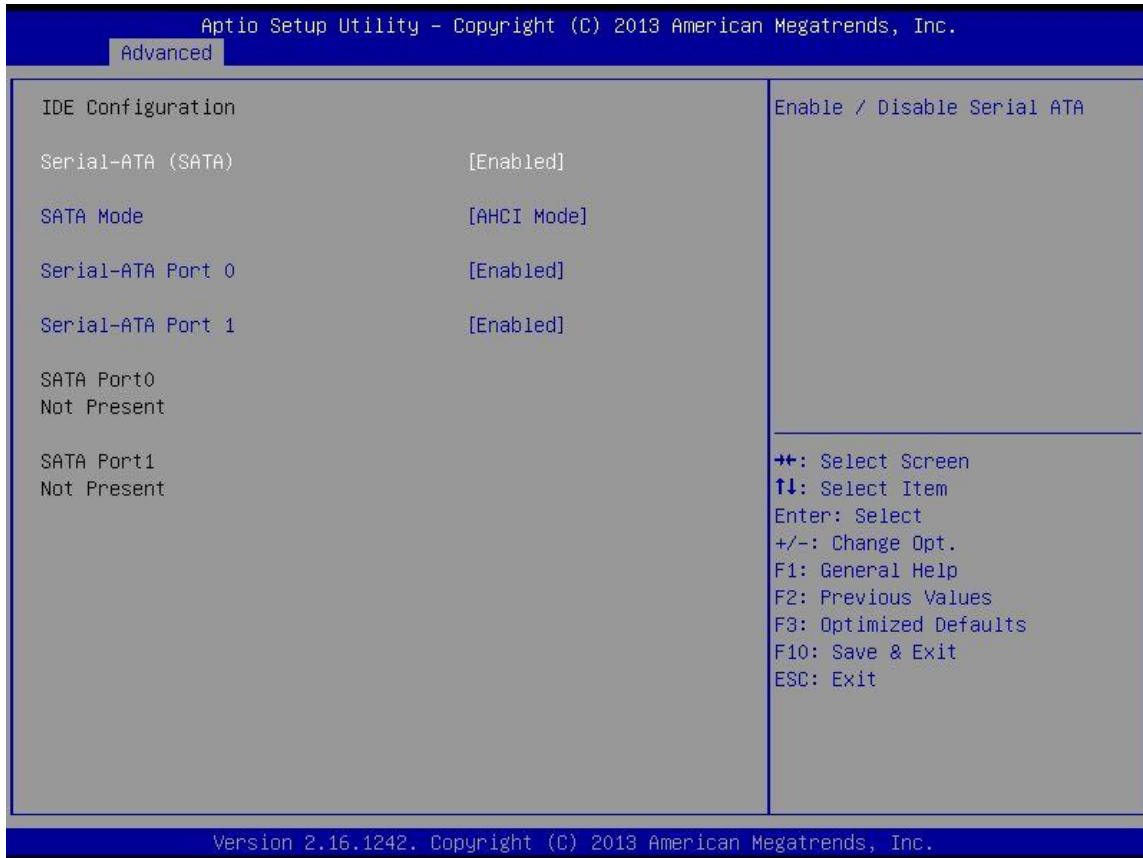

■ Serial-ATA (SATA)

This item will allow users to enable or disable Serial ATA.

■ SATA Mode

This item will allow users to select IDE or AHCI Mode.

■ Serial – ATA Port 0

This item will allow users to enable or disable Serial-ATA Port 0.

■ Serial – ATA Port 1

This item will allow users to enable or disable Serial-ATA Port 1.

4.3.9 OS Selection

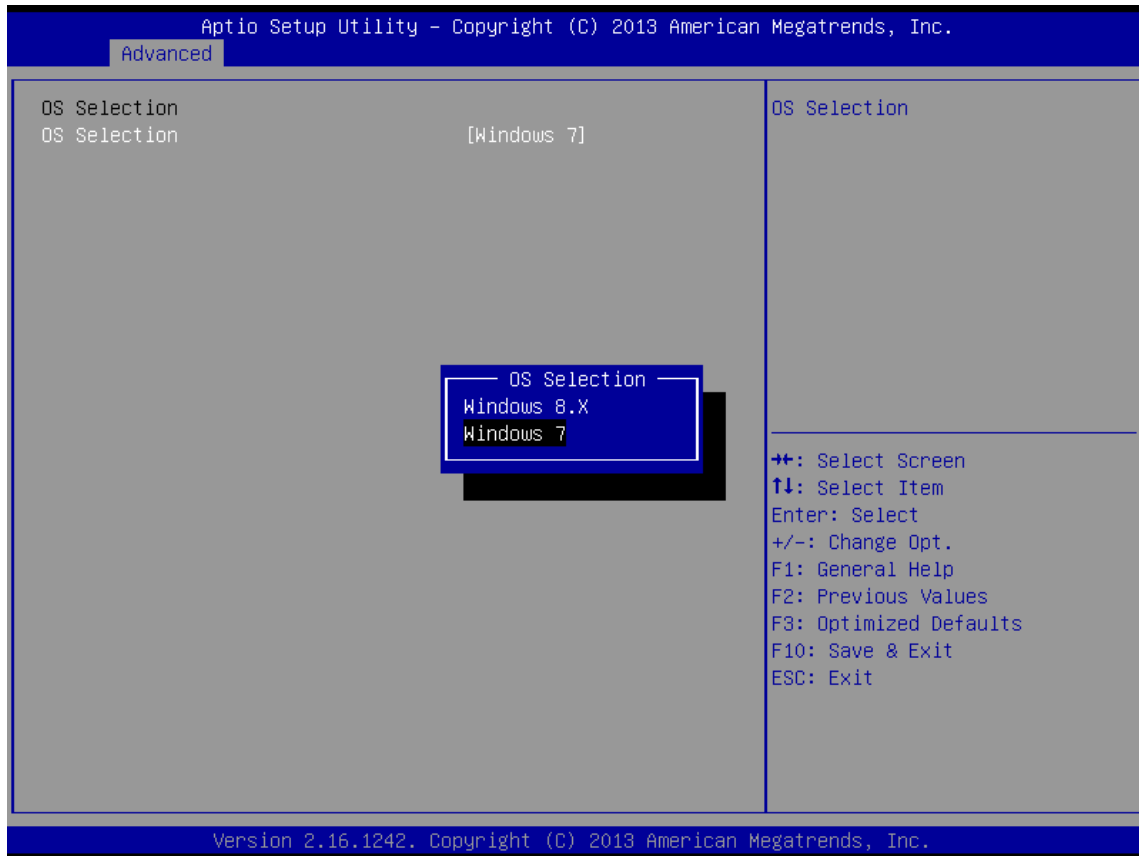

■ OS Selection

This item will allow users to select Windows 8.X or Windows 7 OS.

4.3.10 CSM (Compatibility Support Module) Configuration

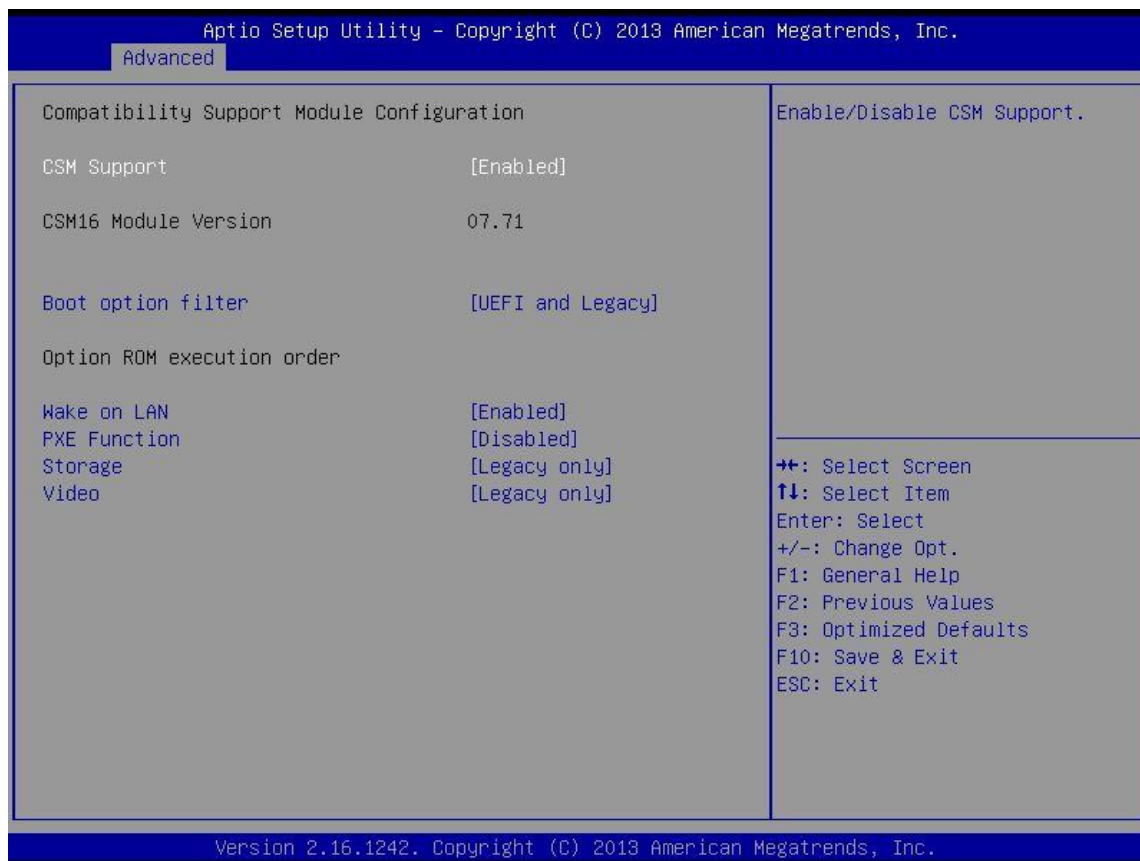

■ CSM Support

Enables or disables UEFI CSM (Compatibility Support Module) to support a legacy PC boot process.

■ Boot option filter

Allows user to select which type of operating system to boot.

UEFI and Legacy: Allows booting from operating systems that support legacy option ROM or UEFI option ROM.

Legacy only: Allows booting from operating systems that only support legacy option ROM.

UEFI only: Allows booting from operating systems that only support UEFI option ROM.

This item is configurable only when CSM Support is set to Enabled.

■ Wake on LAN

This item will allow users to enable or disable wake on LAN function.

■ PXE Function

This item will allow users to enable or disable PXE function.

■ Storage

Allows user to select whether to enable the UEFI or legacy option ROM for the storage device controller.

Do not launch: Disables option ROM.

UEFI only: Enables UEFI option ROM only.

Legacy only: Enables legacy option ROM only.

■ Video

Allows user to select whether to enable the UEFI or legacy option ROM for the storage device controller.

Do not launch: Disables option ROM.

UEFI only: Enables UEFI option ROM only.

Legacy only: Enables legacy option ROM only.

4.3.11 USB Configuration

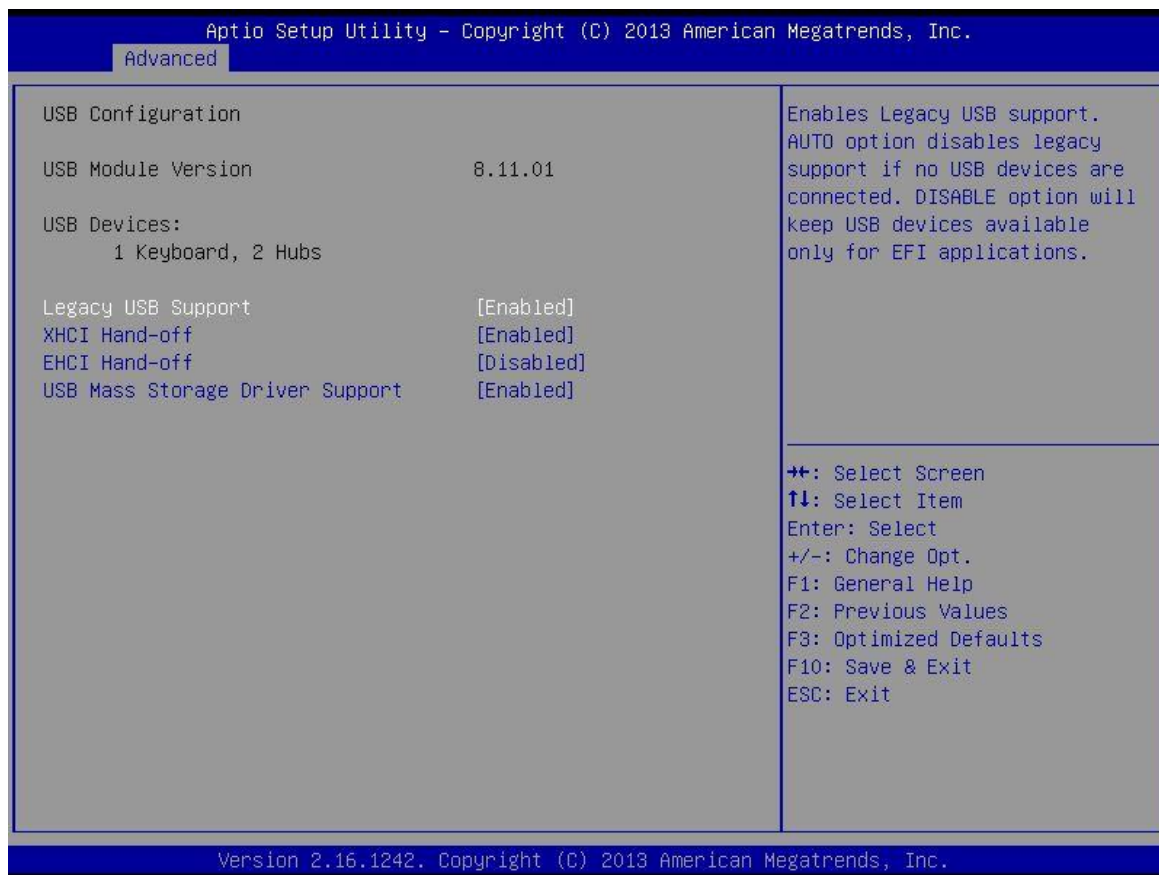

■ Legacy USB Support

Allows USB keyboard/ mouse to be used in MS-DOS.

■ XHCI Hand-off

Determines whether to enable XHCI (USB3.0) Hand-off feature for an operating system without XHCI (USB3.0) Hand-off support.

■ EHCI Hand-off

Determines whether to enable EHCI Hand-off feature for an operating system without EHCI Hand-off support.

■ USB Mass Storage Driver Support

Enables or disables support for USB storage devices.

4.4 Chipset



4.4.1 North Bridge

This section provides information on the installed memory size and memory/onboard graphics-related configuration options.

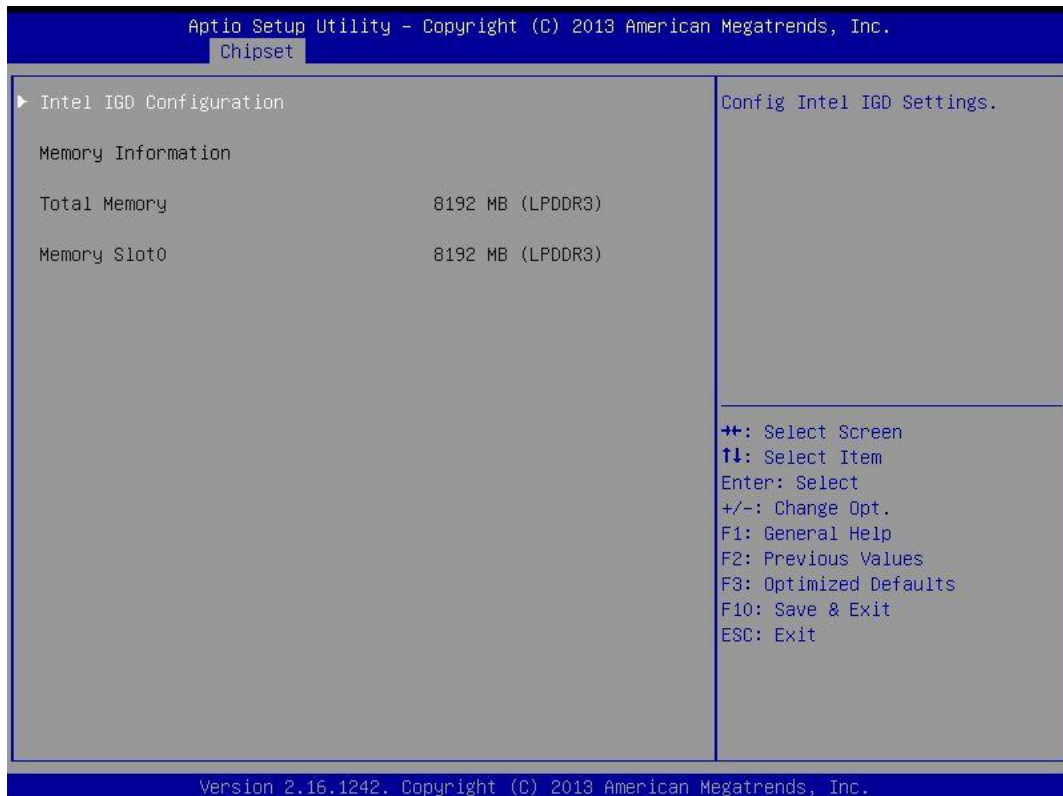

■ Intel IGD Configuration

This section provides onboard graphics-related configuration options.

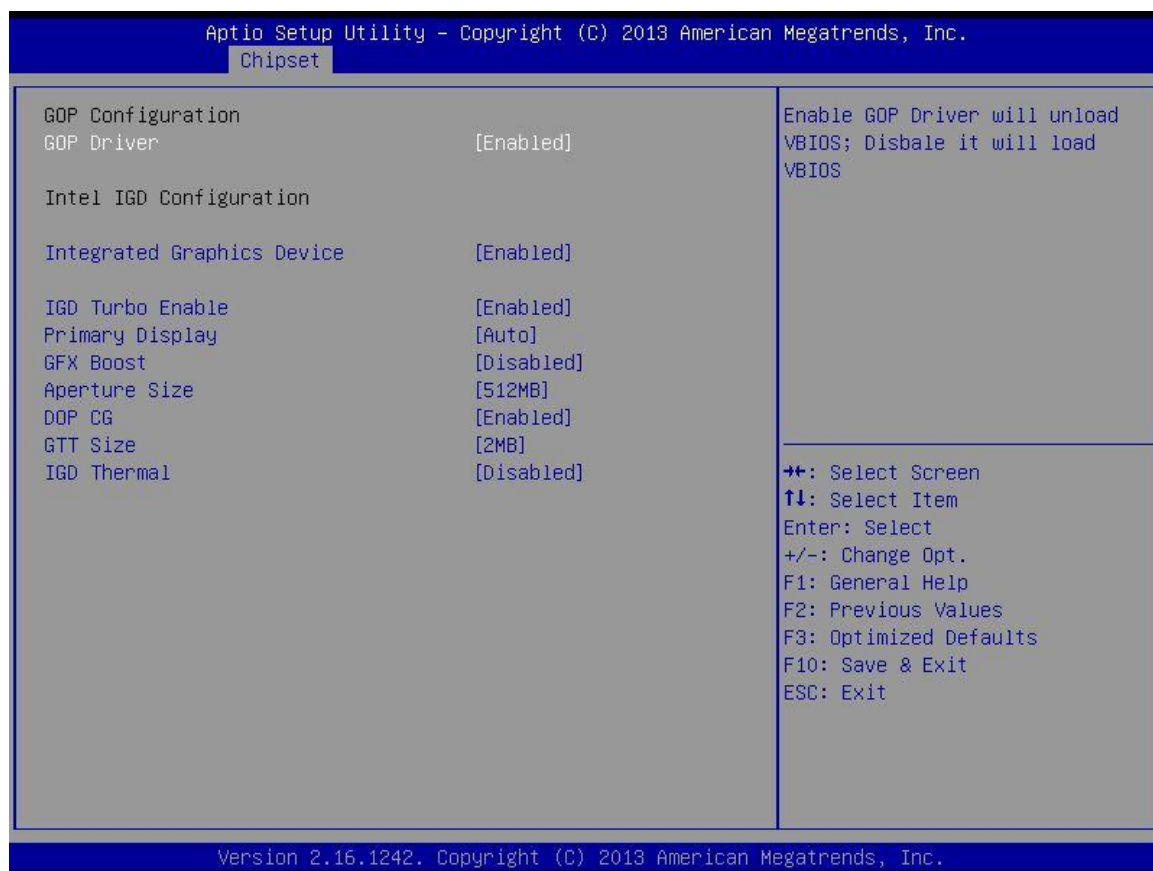

❑ GOP Driver

This item will allow users to enable or disable GOP Driver.

❑ Integrated Graphics Device

This item will allow users to enable or disable Integrated Graphics Device.

❑ IGD Turbo Enable

This item will allow users to enable or disable IGD Turbo.

❑ Primary Display

"Auto or IGFX or PEG or PCIE or SG" optimal to Primary Display.

❑ GFX Boost

This item will allow users to enable or disable GFX Boost.

❑ Aperture Size

Aperture size optimal between 128MB, 256MB, or 512MB.

❑ DOP CG

This item will allow users to enable or disable DOP CG.

❑ GTT Size

GTT size optimal between 1MB or 2MB.

❑ IGD Thermal

This item will allow users to enable or disable IGD Thermal.

4.4.2 South Bridge

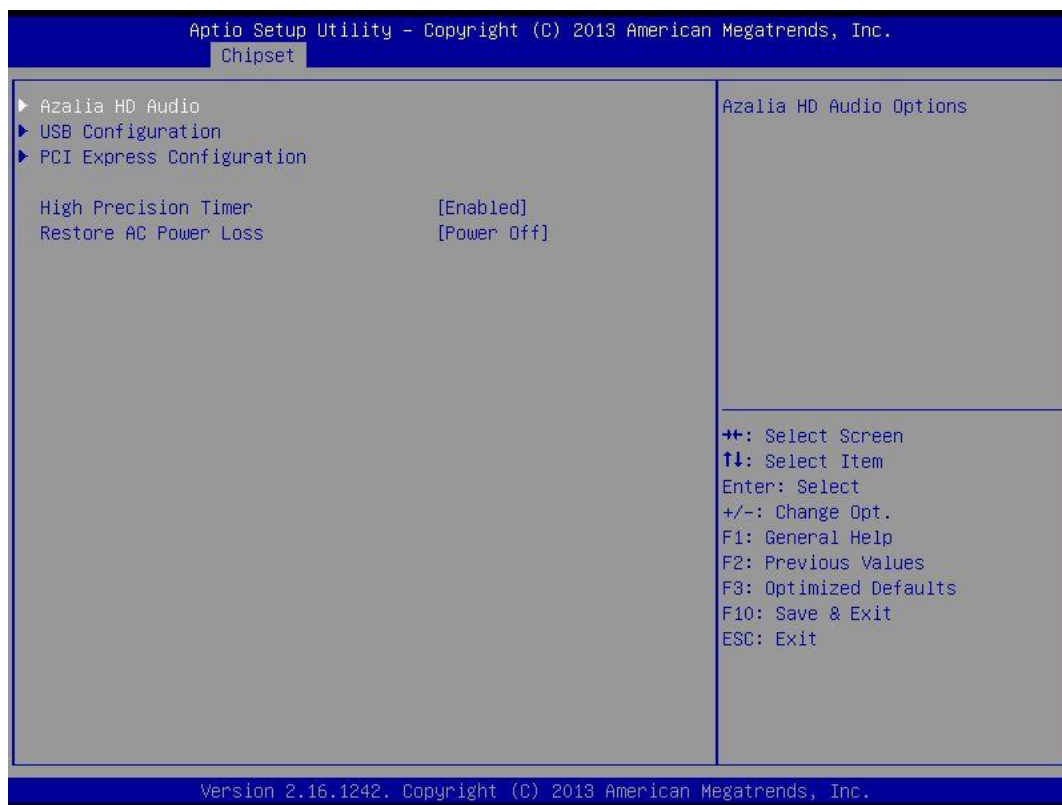

■ Azalia HD Audio

Control detection of the Azalia device.

□ Audio Controller

Enabled: Azalia will be unconditionally enabled.

Disabled: Azalia will be unconditionally disabled.

■ USB Configuration

□ XHCI Mode

This setting disables/enables the USB XHCI controller. The eXtensible Host Controller Interface (XHCI) is a computer interface specification that defines a register-level description of a Host Controller for Universal Serial Bus (USB), which is capable of interfacing to USB 1.0, 2.0, and 3.0 compatible devices. The specification is also referred to as the USB 3.0 Host Controller specification.

□ USB 2 Link Power Management

This setting disables/enables the USB 2 Link Power Management function.

□ USB 2.0 (EHCI) Support

This setting disables/enables the USB EHCI controller. The Enhanced Host Controller Interface (EHCI) specification describes the register-level interface for a Host Controller for the Universal Serial Bus (USB) Revision 2.0.

□ USB Port 0

This item will allow users to enable or disable USB Port 0.

□ USB Port 1

This item will allow users to enable or disable USB Port 1.

□ USB Port 2

This item will allow users to enable or disable USB Port 2.

□ USB Port 3

This item will allow users to enable or disable USB Port 3.

■ PCI Express Configuration

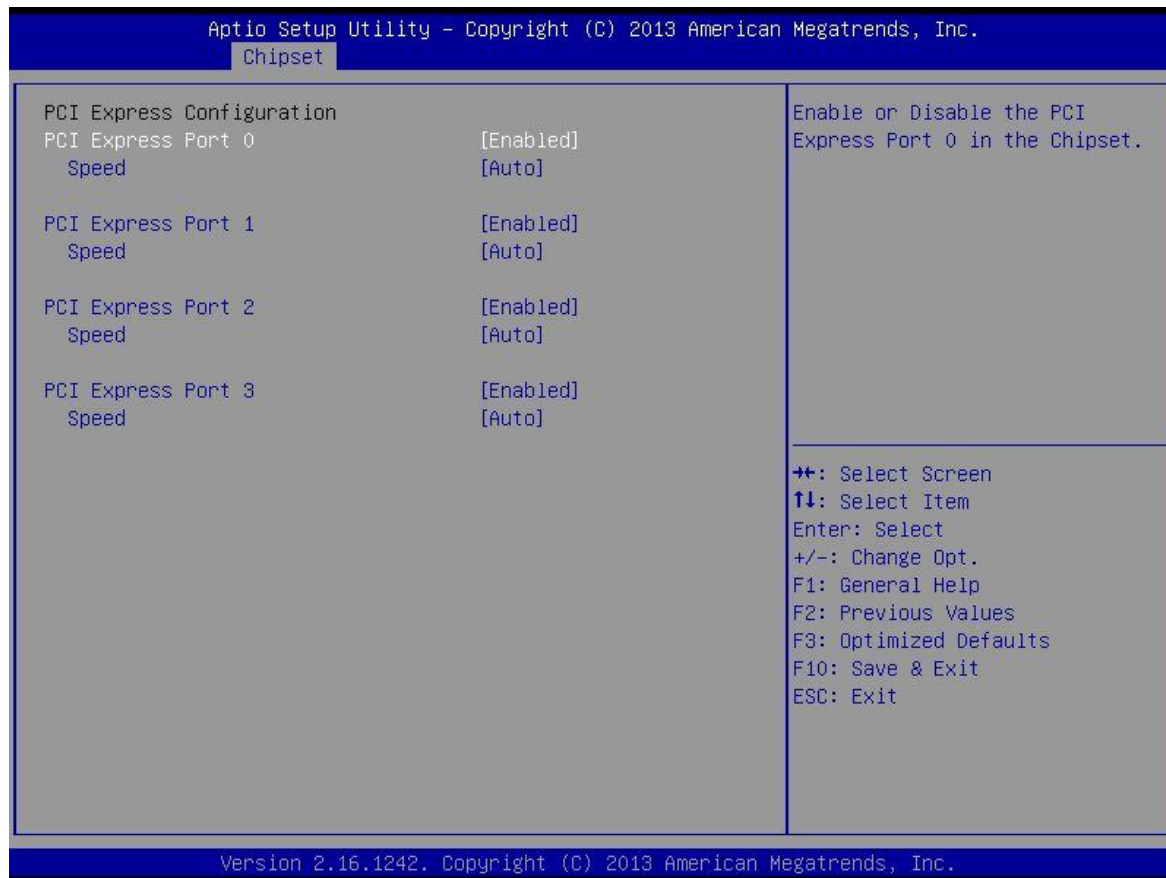

□ PCI Express Port 0

This item will allow users to enable or disable PCI Express Port 0.

□ Speed

Change the PCI Express interface speed. Select <AUTO> ,<Gen 2> or <Gen 1>

□ PCI Express Port 1

This item will allow users to enable or disable PCI Express Port 1.

□ Speed

Change the PCI Express interface speed. Select <AUTO> ,<Gen 2> or <Gen 1>

□ PCI Express Port 2

This item will allow users to enable or disable PCI Express Port 2.

□ Speed

Change the PCI Express interface speed. Select <AUTO> ,<Gen 2> or <Gen 1>

□ PCI Express Port 3

This item will allow users to enable or disable PCI Express Port 3.

□ Speed

Change the PCI Express interface speed. Select <AUTO> ,<Gen 2> or <Gen 1>

■ High Precision Timer

Enable or disable High Precision Event Timer (HPET) in the operating system.

■ Restore AC Power Loss

This setting specifies whether your system will reboot after a power failure or interrupt occurs. Available settings are:

Power Off: Leave the computer in the power off state.

Power On: Leave the computer in the power on state.

Last State: Restore the system to the previous status before power failure or interrupt occurred.

■ Mini-PCIe/MSATA Select (CN4)

This item allows users to select Mini-PCIE or MSATA interface.

4.5 Security

This section allows you to configure and improve your system and allows you to set up some system features according to your preference.

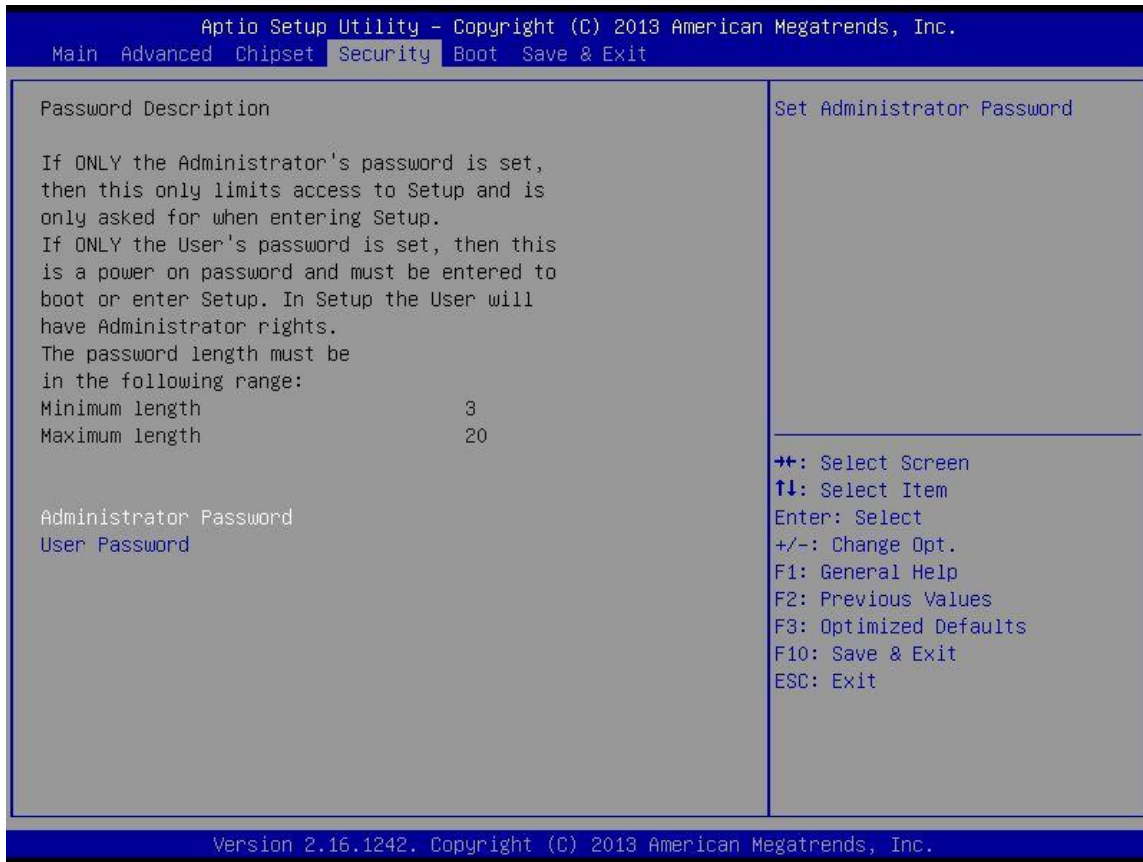

4.5.1 Administrator Password

Administrator Password controls access to the BIOS Setup utility.

4.5.2 User Password

User Password controls access to the system at boot and to the BIOS Setup utility.

4.6 Boot

This section allows you to configure the boot settings.

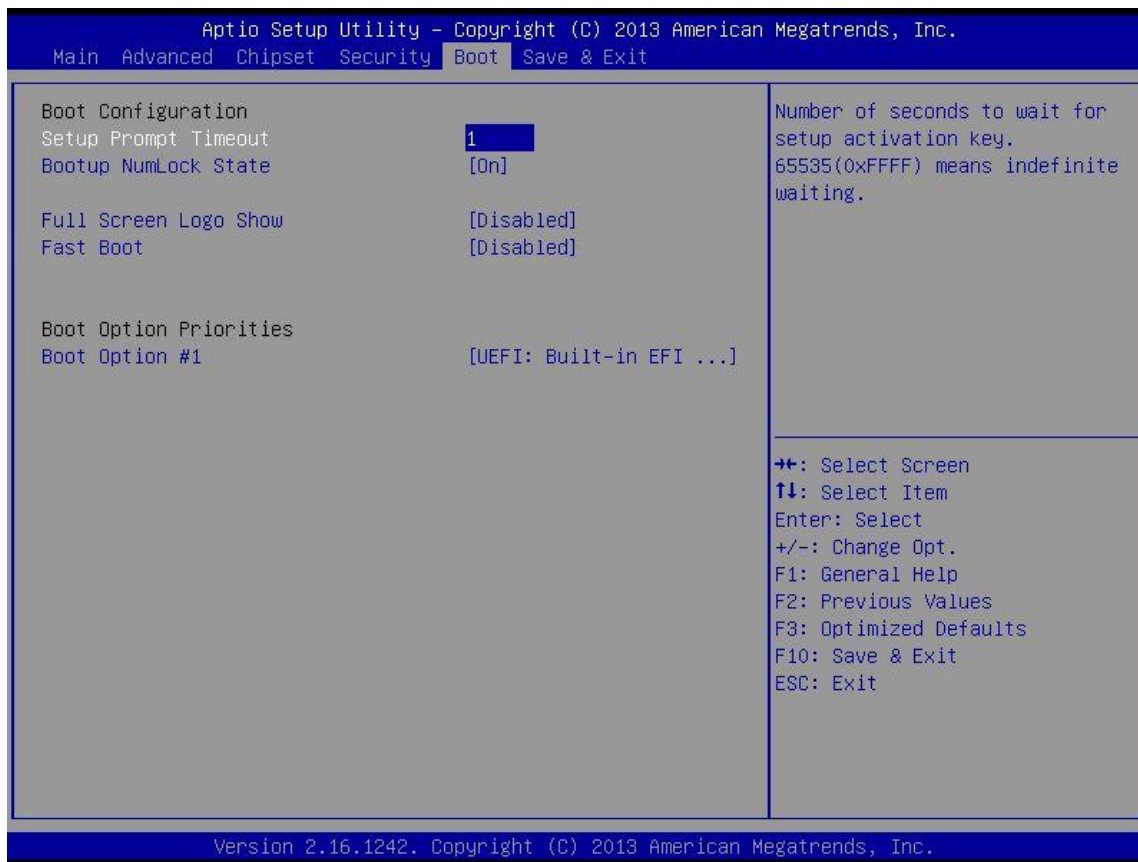

4.6.1 Setup Prompt Timeout

Use this item to set number of seconds to wait for setup activation key.

4.6.2 Bootup NumLock State

Select the Power-on state for Numlock.

4.6.3 Full Screen Logo Show

This item allows user to enable or disable full screen logo show.

4.6.4 Fast Boot

This item allows user to enable or disable Fast Boot option.

4.7 Save & Exit

This section allows you to configure the boot settings.

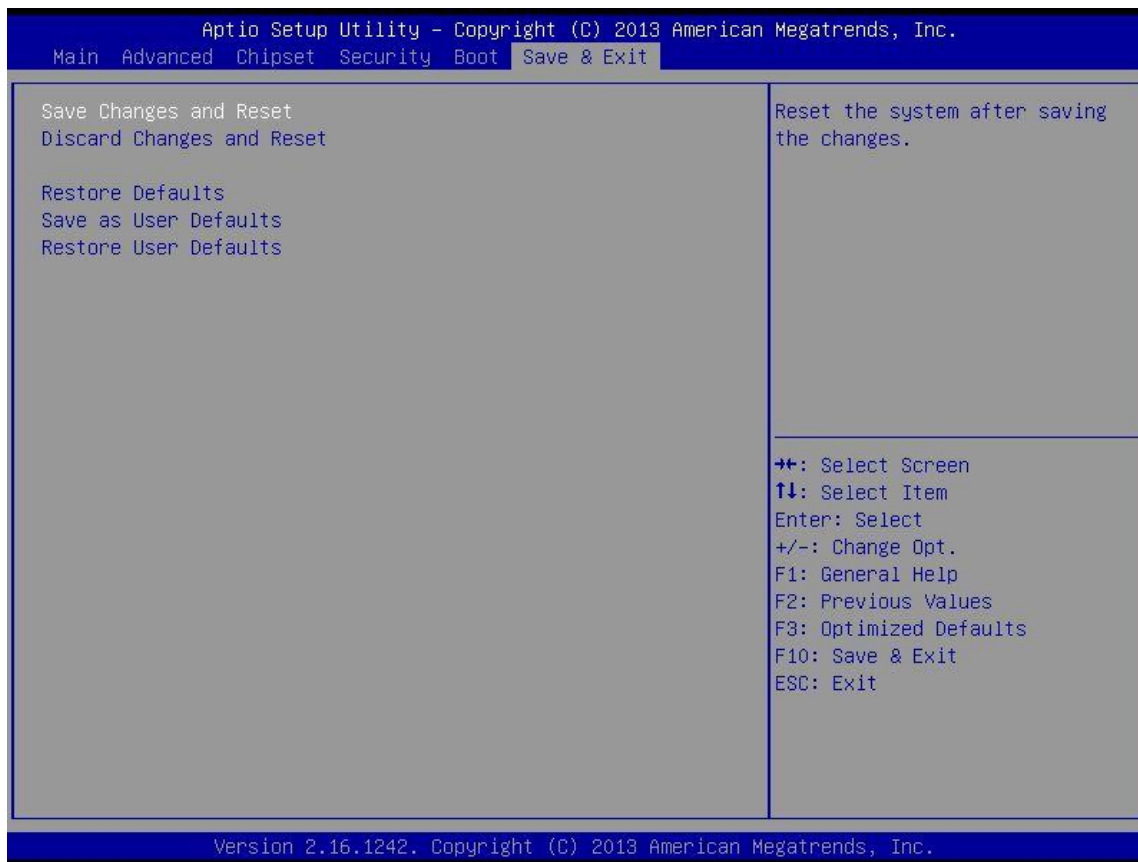

4.7.1 Save Changes and Reset

This item allows user to reset system setup after saving changes.

4.7.2 Discard Changes and Reset

This item allows user to reset system setup without saving any changes.

4.7.3 Restore Defaults

This item allows user to restore/ load default values for all the options.

4.7.4 Save as User Defaults

This item allows user to save the changes done so far as user defaults.

4.7.5 Restore User Defaults

This item allows user to restore the user defaults to all the options.



Chapter 5

Product Application

5.1 Digital I/O (DIO) application

This section describes DIO application of the product. The content and application development are better understood and implemented by well experienced professionals or developers.

5.1.1 Digital I/O Programming Guide

5.1.1.1 Pins for Digital I/O for Cincoze DE series product

Item	Standard
GPIO74 (Pin107)	DI
GPIO75 (Pin108)	
GPIO76 (Pin109)	
GPIO77 (Pin110)	
GPIO80 (Pin111)	DO
GPIO81 (Pin112)	
GPIO82 (Pin113)	
GPIO83 (Pin114)	

5.1.1.2 Programming Guide

To program the Super I/O chip F81866A configuration registers, the following configuration procedures must be followed in sequence:

- (1) Enter the Extended Function Mode
- (2) Configure the configuration registers
- (3) Exit the Extended Function Mode

The configuration register is used to control the behavior of the corresponding devices. To configure the register, use the index port to select the index and then write data port to alter the parameters. The default index port and data port are 0x4E and 0x4F, respectively. **To enable configuration, the entry key 0x87 must be written to the index port. To disable configuration, write exit entry key 0xAA to the index port.** Following is an example to enable configuration and to disable configuration by using debug.

- o 4e 87
- o 4e 87 (enable configuration)
- o 4e aa (disable configuration)

5.1.1.3 Relative Registers

To program the F81866A configuration registers, see the following configuration procedures.

Logic Device Number Register (LDN) — Index 07h

Bit	Name	R/W	Reset	Default	Description
7-0	LDN	R/W	LRESET#	00h	00h: Select FDC device configuration registers. 03h: Select Parallel Port device configuration registers. 04h: Select Hardware Monitor device configuration registers. 05h: Select KBC device configuration registers. 06h: Select GPIO device configuration registers. 07h: Select WDT device configuration registers. 0Ah: Select PME, ACPI and ERP device configuration registers. 10h: Select UART1 device configuration registers. 11h: Select UART2 device configuration registers. 12h: Select UART3 device configuration registers. 13h: Select UART4 device configuration registers. 14h: Select UART5 device configuration registers. 15h: Select UART6 device configuration registers. Otherwise: Reserved.

7.7.11.1GPIO7 Output Enable Register — Index 80h

Bit	Name	R/W	Reset	Default	Description
7	GPIO77_OE	R/W	LRESET#	0	0: GPIO77 is in input mode. 1: GPIO77 is in output mode.
6	GPIO76_OE	R/W	LRESET#	0	0: GPIO76 is in input mode. 1: GPIO75 is in output mode.
5	GPIO75_OE	R/W	LRESET#	0	0: GPIO75 is in input mode. 1: GPIO75 is in output mode.
4	GPIO74_OE	R/W	LRESET#	0	0: GPIO74 is in input mode. 1: GPIO74 is in output mode.

7.7.11.3GPIO7 Pin Status Register — Index 82h (This byte could be also read by base address + 3)

Bit	Name	R/W	Reset	Default	Description
7	GPIO77_IN	R	-	-	The pin status of GPIO77/STB#.
6	GPIO76_IN	R	-	-	The pin status of GPIO76/AFD#.
5	GPIO75_IN	R	-	-	The pin status of GPIO75/ERR#.
4	GPIO74_IN	R	-	-	The pin status of GPIO74/INIT#.

7.7.12.1 GPIO8 Output Enable Register — Index 88h

3	GPIO83_OE	R/W	LRESET#	1	0: GPIO83 is in input mode. 1: GPIO83 is in output mode.
2	GPIO82_OE	R/W	LRESET#	1	0: GPIO82 is in input mode. 1: GPIO82 is in output mode.
1	GPIO81_OE	R/W	LRESET#	1	0: GPIO81 is in input mode. 1: GPIO81 is in output mode.
0	GPIO80_OE	R/W	LRESET#	1	0: GPIO80 is in input mode. 1: GPIO80 is in output mode.

7.7.12.2 GPIO8 Output Data Register — Index 89h (This byte could be also written by base address + 2)

3	GPIO83_VAL	R/W	LRESET#	1	0: GPIO83 outputs 0 when in output mode. 1: GPIO83 outputs 1 when in output mode.
2	GPIO82_VAL	R/W	LRESET#	1	0: GPIO82 outputs 0 when in output mode. 1: GPIO82 outputs 1 when in output mode.
1	GPIO81_VAL	R/W	LRESET#	1	0: GPIO81 outputs 0 when in output mode. 1: GPIO81 outputs 1 when in output mode.
0	GPIO80_VAL	R/W	LRESET#	1	0: GPIO80 outputs 0 when in output mode. 1: GPIO80 outputs 1 when in output mode.

5.1.1.4 Sample Code in C Language

5.1.1.4.1 Control of GP74 to GP77 (DI1 ~ DI4)

```
#define AddrPort 0x4E
#define DataPort 0x4F
```

<Enter the Extended Function Mode>

```
WriteByte(AddrPort, 0x87)
```

```
WriteByte(AddrPort, 0x87) // Must write twice to enter Extended mode
```

<Select Logic Device>

```
WriteByte(AddrPort, 0x07)
```

```
WriteByte(dataPort, 0x06)
```

```
//Select logic device 06h
```

<Input Mode Selection> //Set GP74 to GP77 input Mode

```
WriteByte(AddrPort, 0x80) // Select configuration register 80h
```

```
WriteByte(DataPort, 0x0X)
```

```
//Set (bit 4~7) = 0 to select GP 74~77 as Input mode.
```

<input Value>

```
WriteByte(AddrPort, 0x82) // Select configuration register 82h
```

```
ReadByte(DataPort, Value) // Read bit 4~7(0xFx)= GP74 ~77  
as High.
```

<Leave the Extended Function Mode>

```
WriteByte(AddrPort, 0xAA)
```

5.1.1.4.2 Control of GP80 to GP83 (DO1 ~ DO4)

```
#define AddrPort 0x4E  
#define DataPort 0x4F
```

<Enter the Extended Function Mode>

```
WriteByte(AddrPort, 0x87)  
WriteByte(AddrPort, 0x87) // Must write twice to enter Extended mode
```

<Select Logic Device>

```
WriteByte(AddrPort, 0x07)  
WriteByte(DataPort, 0x06)  
// Select logic device 06h
```

<Output Mode Selection> //Set GP80 to GP83 output Mode

```
WriteByte(AddrPort, 0x88) // Select configuration register 88h  
WriteByte(DataPort, (0xXF))  
//Set (bit 0~3) = 1 to select GP 80 ~83 as Output mode.
```

<Output Value>

```
WriteByte(AddrPort, 0x89) // Select configuration register 89h  
WriteByte(DataPort, Value) // Set bit 0~3=(0/1) to output GP 80~83  
as Low or High
```

<Leave the Extended Function Mode>

```
WriteByte(AddrPort, 0xAA)
```

5.1.1.5 Change base address - DIO base address (Cincoze default 0xA00)

<Enter the Extended Function Mode>

WriteByte(AddrPort, 0x87)

WriteByte(AddrPort, 0x87) // Must write twice to enter Extended mode

<Select Logic Device>

WriteByte(AddrPort, 0x07)

WriteByte(dataPort, 0x06)

// Select logic device 06h

WriteByte(AddrPort, 0x60) // Select configuration register 60h (High Byte address)

WriteByte(DataPort, (0x0A))

WriteByte(AddrPort, 0x61) // Select configuration register 61h (Low Byte address)

WriteByte(DataPort, (0x00))

<Leave the Extended Function Mode>

WriteByte(AddrPort, 0xAA)

Cincoze DIO Port base address is 0x0A00h

5.1.1.6 DATA Bit Table (DI/O)

7	6	5	4	3	2	1	0	bit
0	0	0	1	-	-	-	-	value
1				X				/h

= DI1
(Base Address +3)
(0xA03)

7	6	5	4	3	2	1	0	bit
-	-	-	-	0	0	0	1	value
X				1				/h

= DO1
(Base Address +2)
(0xA02)

7	6	5	4	3	2	1	0	bit
0	0	1	0	-	-	-	-	value
2				X				/h

= DI2
(Base Address +3)
(0xA03)

7	6	5	4	3	2	1	0	bit
-	-	-	-	0	0	1	0	value
X				2				/h

= DO2
(Base Address +2)
(0xA02)

7	6	5	4	3	2	1	0	bit
0	1	0	0	-	-	-	-	value
4				X				/h

= DI3
(Base Address +3)
(0xA03)

7	6	5	4	3	2	1	0	bit
-	-	-	-	0	1	0	0	value
X				4				/h

= DO3
(Base Address +2)
(0xA02)

7	6	5	4	3	2	1	0	bit
1	0	0	0	-	-	-	-	value
8				X				/h

= DI4
(Base Address +3)
(0xA03)

7	6	5	4	3	2	1	0	bit
-	-	-	-	1	0	0	0	value
X				8				/h

= DO4
(Base Address +2)
(0xA02)

5.1.1.7 DIO I/O Port Address

DI4	DI3	DI2	DI1	DO4	DO3	DO2	DO1	Pin Definition
7	6	5	4	3	2	1	0	Data Bits
DI				DO				DIO
0xA03				0xA02				I/O Port address

5.2 Digital I/O (DIO) Hardware Specification

- XCOM+ / 2XCOM+ : Isolated power in V+
- XCOM- / 2XCOM- : Isolated power in V-
- Isolated power in DC voltage : 9~30V

- 8x Digital Input (Source Type)
 - Input Signal Voltage Level
 - Signal Logic 0 : XCOM+ = 9V, Signal Low - V- < 1V
XCOM+ > 9V, V+ - Signal Low > 8V
 - Signal Logic 1 : > XCOM+ - 3V

- Input Driving Sink Current :
 - Minimal : 1 mA
 - Normal : 5 mA

- 8x Digital Output (Open Drain)
 - DO Signal have to pull up resistor to XCOM+ for external device, the resistance will affect the pull up current
 - Signal High Level : Pull up resistor to XCOM+
 - Signal Low Level : = XCOM-
 - Sink Current: 1A (Max)



www.cincoze.com

© 2014 Cincoze Co., Ltd. All rights reserved.

The Cincoze logo is a registered trademark of Cincoze Co., Ltd.

All other logos appearing in this catalog are the intellectual property of the respective company, product, or organization associated with the logo.

All product specifications and information are subject to change without notice.