

User's Manual

Rugged Embedded Computer

6th Generation Intel® Core™ (Skylake-U)

High Performance, Compact and Modular Rugged Embedded Computer

DI-1000 Series



Preface

Revision	05
Copyright Notice	05
Acknowledgement	05
Disclaimer	05
Declaration of Conformity	05
Product Warranty Statement	06
Technical Support and Assistance	07
Conventions Used in this Manual	07
Safety Precautions	08
Package Contents	09
Ordering Information	09
Optional Modules & Accessories	10

Chapter 1 Product Introductions

1.1 Overview	12
1.2 Highlights	12
1.3 Product Pictures.....	13
1.4 Key Features	13
1.5 Hardware Specification	14
1.6 System I/O	15
1.6.1 Front.....	15
1.6.2 Rear.....	16
1.7 Mechanical Dimension	17

Chapter 2 System Pin Definitions and Settings

2.1 Settings	19
2.2 Location of Connectors , Jumpers and Switches	19
2.2.1 Top View.....	19
2.2.2 Bottom View.....	20
2.3 Connector / Jumper / Switch Definition.....	21
2.4 Definition of Switches	22
2.5 Definition of Connectors	24

Chapter 3 Optional Module Pin Definitions and Settings

3.1 CMI-M12LAN104/CMI-M12POE104 Connector	29
3.2 CMI-M12LAN104/CMI-M12POE104 Connector	29
3.3 CFM-IGN Power Ignition Module Connector Location.....	30
3.4 Definitions of Switches.....	30

Chapter 4 System Setup

4.1 Disassembling the System for Installation	34
4.2 Installing Components on Top Side.....	36
4.2.1 Installing SO-DIMM Memory.....	36
4.2.2 Installing a Mini-PCIe/mSATA Card.....	37
4.2.3 Installing Antennas.....	39
4.3 Installing Components on Bottom Side.....	42
4.3.1 Installing a SATA Hard Drive.....	42
4.3.2 Installing a CFM-IGN Power Ignition Module.....	43
4.3.3 Installing a High Speed CMI Module	45
4.4 Assembling the System.....	48
4.4.1 Installing Thermal Pad	48
4.4.2 Installing Top Cover	50
4.4.3 Installing Bottom Cover	51
4.5 Installing Components at Front Side.....	52
4.5.1 Removing the Front Cover Plate.....	52
4.5.2 Installing a SATA Hard Drive at Front Side	52

4.5.3	Installing a SIM Card	55
4.5.4	Installing the Front Cover Plate	56
4.6	Wall Mount Brackets.....	56
4.7	DIN-Rail Mount Brackets.....	58
4.8	VESA Mount	60
4.9	Side Mount Brackets.....	61

Chapter 5 BIOS Setup

5.1	BIOS Introduction	64
5.2	Main Setup	65
5.2.1	System Date	65
5.2.2	System Time	65
5.3	Advanced Setup	66
5.3.1	ACPI Settings	66
5.3.2	AMT Configuration	67
5.3.3	PCH-FW Configuration	68
5.3.4	F81866 Super IO Configuration	69
5.3.5	Hardware Monitor	70
5.3.6	S5 RTC Wake Settings	71
5.3.7	Serial Port Console Redirection	72
5.3.8	CPU Configuration	72
5.3.9	SATA Configuration	73
5.3.10	CSM Configuration	75
5.3.11	Asmedia SATA Controller Configuration.....	76
5.3.12	USB Configuration	77
5.3.13	Intel® I210 Gigabit Network Connection Intel® Ethernet Connection I219-LM.....	78
5.4	Chipset Setup	79
5.4.1	System Agent (SA) Configuration	79
5.4.2	PCH-IO Configuration	80
5.5	Security Setup	83
5.5.1	Administrator Password	83
5.5.2	User Password	83
5.6	Boot Setup	84
5.6.1	Setup Prompt Timeout.....	84
5.6.2	Bootup NumLock State	84
5.6.3	Quiet Boot	84
5.6.4	Fast Boot	84
5.6.5	New Boot Option Policy	84
5.6.6	Hard Drive BBS Priority.....	84
5.7	Save & Exit	85
5.7.1	Save Changes and Exit	85
5.7.2	Discard Changes and Exit	85
5.7.3	Save Changes and Reset	85
5.7.4	Discard Changes and Reset	85
5.7.5	Save Changes	85
5.7.6	Discard Changes	85
5.7.7	Restore Defaults	85
5.7.8	Save as User Defaults	85
5.7.9	Restore User Defaults	85

Chapter 6 Product Application

- 6.1 Digital I/O (DIO) Application.....87
 - 6.1.1 Digital I/O Programming Guide 87
- 6.2 Digital I/O (DIO) Hardware Specification 92
 - 6.2.1 DIO Connector Definitions 93

Preface

Revision

Revision	Description	Date
1.0	New Release	2017/03/09
1.1	Correct 1.2 highlights section M12 module errors	2017/03/31
1.2	Modify 2.4 Definition of Switches & Add E-Mark certification	2017/04/20
1.3	Add 3.1& 3.2 pin definitions of CMI-M12LAN104 and CMI-M12POE114	2017/06/16
1.4	Add a new model DI-1000-i3	2017/07/25
1.41	Modify the table in the Definition of Switches	2017/11/08
1.42	Add a new model DI-1000-i7	2018/01/09
1.50	Correction Made	2018/11/20
1.60	Update the Supporting Capacity of Memory to the latest	2019/11/08

Copyright Notice

© 2016 by Cincoze Co., Ltd. All rights are reserved. No parts of this manual may be copied, modified, or reproduced in any form or by any means for commercial use without the prior written permission of Cincoze Co., Ltd. All information and specification provided in this manual are for reference only and remain subject to change without prior notice.

Acknowledgement

Cincoze is a registered trademark of Cincoze Co., Ltd. All registered trademarks and product names mentioned herein are used for identification purposes only and may be trademarks and/or registered trademarks of their respective owners.

Disclaimer

This manual is intended to be used as a practical and informative guide only and is subject to change without notice. It does not represent a commitment on the part of Cincoze. This product might include unintentional technical or typographical errors. Changes are periodically made to the information herein to correct such errors, and these changes are incorporated into new editions of the publication.

Declaration of Conformity



FCC

This equipment has been tested and found to comply with the limits for a Class A digital device, pursuant to Part 15 of the FCC Rules. These limits are designed to provide reasonable protection against harmful interference when the equipment is operated in a commercial environment. This equipment generates, uses, and can radiate radio frequency energy and, if not installed and used in accordance with the instruction manual, may cause harmful interference to radio communications. Operation of this equipment in a residential area is likely to cause harmful interference in which case the user will be required to correct the interference at his own expense.



CE

The product(s) described in this manual complies with all application European Union (CE) directives if it has a CE marking. For computer systems to remain CE compliant, only CE-compliant parts may be used. Maintaining CE compliance also requires proper cable and cabling techniques.

Product Warranty Statement

Warranty

Cincoze products are warranted by Cincoze Co., Ltd. to be free from defect in materials and workmanship for 2 years from the date of purchase by the original purchaser.

During the warranty period, we shall, at our option, either repair or replace any product that proves to be defective under normal operation.

Defects, malfunctions, or failures of the warranted product caused by damage resulting from natural disasters (such as by lightning, flood, earthquake, etc.), environmental and atmospheric disturbances, other external forces such as power line disturbances, plugging the board in under power, or incorrect cabling, and damage caused by misuse, abuse, and unauthorized alteration or repair, and the product in question is either software, or an expendable item (such as a fuse, battery, etc.), are not warranted.

RMA

Before sending your product in, you will need to fill in Cincoze RMA Request Form and obtain a RMA number from us. Our staff is available at any time to provide you with the most friendly and immediate service.

■ RMA Instruction

- Customers must fill in Cincoze Return Merchandise Authorization (RMA) Request Form and obtain a RMA number prior to returning a defective product to Cincoze for service.
- Customers must collect all the information about the problems encountered and note anything abnormal and describe the problems on the "Cincoze Service Form" for the RMA number apply process.
- Charges may be incurred for certain repairs. Cincoze will charge for repairs to products whose warranty period has expired. Cincoze will also charge for repairs to products if the damage resulted from acts of God, environmental or atmospheric disturbances, or other external forces through misuse, abuse, or unauthorized alteration or repair. If charges will be incurred for a repair, Cincoze lists all charges, and will wait for customer's approval before performing the repair.
- Customers agree to insure the product or assume the risk of loss or damage during transit, to prepay shipping charges, and to use the original shipping container or equivalent.
- Customers can be send back the faulty products with or without accessories (manuals, cable, etc.) and any components from the system. If the components were suspected as part of the problems, please note clearly which components are included. Otherwise, Cincoze is not responsible for the devices/parts.
- Repaired items will be shipped along with a "Repair Report" detailing the findings and actions taken.

Limitation of Liability

Cincoze' liability arising out of the manufacture, sale, or supplying of the product and its use, whether based on warranty, contract, negligence, product liability, or otherwise, shall not exceed the original selling price of the product. The remedies provided herein are the customer's sole and exclusive remedies. In no event shall Cincoze be liable for direct, indirect, special or consequential damages whether based on contract of any other legal theory.

Technical Support and Assistance

1. Visit the Cincoze website at www.cincoze.com where you can find the latest information about the product.
2. Contact your distributor or our technical support team or sales representative for technical support if you need additional assistance. Please have following information ready before you call:
 - Product name and serial number
 - Description of your peripheral attachments
 - Description of your software (operating system, version, application software, etc.)
 - A complete description of the problem
 - The exact wording of any error messages

Conventions Used in this Manual



WARNING

This indication alerts operators to an operation that, if not strictly observed, may result in severe injury.



CAUTION

This indication alerts operators to an operation that, if not strictly observed, may result in safety hazards to personnel or damage to equipment.



NOTE

This indication provides additional information to complete a task easily.

Safety Precautions

Before installing and using this device, please note the following precautions:

1. Read these safety instructions carefully.
2. Keep this User's Manual for future reference.
3. Disconnect this equipment from any AC outlet before cleaning.
4. For plug-in equipment, the power outlet socket must be located near the equipment and must be easily accessible.
5. Keep this equipment away from humidity.
6. Put this equipment on a reliable surface during installation. Dropping it or letting it fall may cause damage.
7. Make sure the voltage of the power source is correct before connecting the equipment to the power outlet.
8. Use a power cord that has been approved for using with the product and that it matches the voltage and current marked on the product's electrical range label. The voltage and current rating of the cord must be greater than the voltage and current rating marked on the product.
9. Position the power cord so that people cannot step on it. Do not place anything over the power cord.
10. All cautions and warnings on the equipment should be noted.
11. If the equipment is not used for a long time, disconnect it from the power source to avoid damage by transient overvoltage.
12. Never pour any liquid into an opening. This may cause fire or electrical shock.
13. Never open the equipment. For safety reasons, the equipment should be opened only by qualified service personnel.

If one of the following situations arises, get the equipment checked by service personnel:

- The power cord or plug is damaged.
 - Liquid has penetrated into the equipment.
 - The equipment has been exposed to moisture.
 - The equipment does not work well, or you cannot get it work according to the user's manual.
 - The equipment has been dropped and damaged.
 - The equipment has obvious signs of breakage.
14. **CAUTION:** Danger of explosion if battery is incorrectly replaced. Replace only with the same or equivalent type recommended by the manufacturer.

Package Contents

Before installation, please ensure all the items listed in the following table are included in the package.

Item	Description	Q'ty
1	Embedded System	1
2	CPU Heatsink Thermal Pad	1
3	Utility DVD Driver	1
4	Screw Pack	1
5	Wall Mounting Kit	1
6	Power Terminal Block Connector	1
7	Remote Power On/Off Terminal Block Connector	1
8	DIO Terminal Block Connector	2
9	DVI-I to VGA Adaptor	1

Note: Notify your sales representative if any of the above items are missing or damaged.

Ordering Information

Model No.	Product Description
DI-1000-i3	6 th Generation Intel® Core™ i3-6100U High Performance, Compact and Modular Rugged Embedded Computer
DI-1000-i5	6 th Generation Intel® Core™ i5-6300U High Performance, Compact and Modular Rugged Embedded Computer
DI-1000-i7	6th Gen. Intel® Core™ i7-6600U High Performance, Compact and Modular Rugged Embedded Computer

Optional Modules & Accessories

Model No.	Description
CFM-IGN102	CFM Module with Power Ignition Sensing Control Function, Selectable 12V/24V
CMI-LAN104/UB0712	CMI Module with 4x Intel GbE LAN, RJ45 Port, 1x Universal Bracket
CMI-PoE114/UB0712	CMI Module with 4x PoE+, Intel GbE LAN, RJ45 Port, Individual Port 25.5W, 1x Universal Bracket
CMI-M12LAN104/UB0710	CMI Module with M12 Connector, 4x Intel GbE LAN, 1x Universal Bracket
CMI-M12PoE114/UB0710	CMI Module with M12 Connector, 4x PoE+, Intel GbE LAN, Individual Port 25.5W, 1x Universal Bracket
MEC-COM-M212/UB0703	Mini-PCIe Module with 2x COM Ports, 2x Universal Brackets
MEC-FIR-M003/UB0701	Mini-PCIe Module with 1x 1394A Port, 2x 1394B Ports, 1x Universal Bracket
MEC-LAN-M002-R1 /UB0711	Mini-PCIe Module with 2x LAN Ports, 1x Universal Bracket
MEC-USB-M002 /UB0714/CB0101	Mini-PCIe Module with 2x USB 3.0 Ports, 1x Universal Bracket, 1x Cable for MEC-USB
DIN01	DIN-RAIL Mount Kit, KMRH-K175
SIDE01	SIDE Mount Kit
GSM60A12-CIN1	Adapter AC/DC 12V 5A 60W with 3pin Terminal Block Plug 5.0mm Pitch, with Tubes
GS120A24-CIN1	Adapter AC/DC 24V 5A 120W with 3pin Terminal Block Plug 5.0mm Pitch, with Tubes



Chapter 1

Product Introductions

1.1 Overview

Cincoze DI-1000 Series is a high-performance, compact and modular fanless embedded computer powered by 6th generation Intel® Core™ mobile processor (Skylake-U), it integrates Intel® HD graphic engine and accommodates one DDR4 socket up to 32 GB which allows DI-1000 Series to fulfill all kinds of high-end computing demands. Extremely compact size with dimension 203 x 142 x 66.8 mm, comprising unbeatable I/O such as DVI-I, DP, 2x LAN, 6x COM, 6x USB, 8x Optical Isolated DIO, PS/2, Mic-in, Line-out, and remote power on/off switch, supporting two full-size Mini-PCIe slots for wireless communication and I/O expansion, accommodating two 2.5" SATA HDD/SSD bay for RAID 0/1 function, making DI-1000 series unmatched in the market for its size and functions. DI-1000 Series weighs only 1.65 kg supporting 4 types of mounting mechanisms (Wall, DIN, Side and VESA) allowing it to be installed everywhere. The unique Cincoze's CMI (Combined Multiple I/O), CFM (Control Function Module) and MEC (Mini-PCIe Card) technologies allow DI-1000 Series to be expanded according to the specific needs. The options of ready-to-use modules including Multi-LAN, PoE, M12 connections, Power Ignition Sensing and various types of I/O interface, making DI-1000 series application-ready platform for factory automation, machine vision, in-vehicle, and mobile surveillance applications.

1.2 Highlights

High Performance

- Onboard 6th Generation Intel® Core™ Mobile Processor
- Performance Enhanced by Intel® 14 nm Technology
- Extremely Low Power Consumption 15W TDP
- Intel® HD Graphics Supports Triple Independent Display Resolution Up to Ultra HD 4K



Compact Size

- Compact Size 203 x 142 x 66.8 mm with Light Weight 1.65 kg
- Rich I/O for Greater Device Connectivity (DVI, DisplayPort, 2x GbE LAN, 6x COM, 6x USB, 8x Optical Isolated DIO, PS/2)



Modular Design

- CMI (Combined Multiple I/O) Technology for LAN, PoE and M12 Connector Expansion
- CFM (Control Function Module) Technology for Power Ignition Sensing (IGN) Function Expansion
- Mini-PCIe Module Kits for Various I/O Expansion

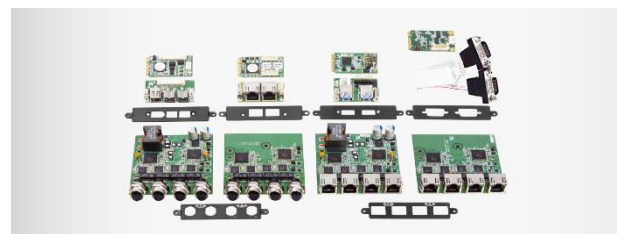

1.3 Product Pictures

Front



Rear



1.4 Key Features

- Onboard 6th Generation Intel® Core™ Mobile Processor (BGA Type)
- 1x DDR4 SO-DIMM Socket, 2133MHz, Supports Up to 32 GB
- Triple Independent Display (DVI-I, DisplayPort)
- Compact Size 203 x 142 x 66.8 mm with Light Weight 1.65 kg
- 1x Hot-swappable 2.5" SATA HDD/SSD Bay and 1x Internal 2.5" SATA HDD/SSD Bay, Supports RAID 0/1
- Rich I/O Including DVI, DP, 2x GbE LAN, 6x COM, 6x USB, 8x Optical Isolated DIO
- Supports Cincoze CMI Technology for LAN, PoE & M12 Connector Expansion
- Supports Cincoze CFM Technology for Power Ignition Sensing (IGN) Function Expansion
- Cincoze MEC Module Kits for Various I/O Expansion
- 2x Full-size Mini-PCIe Slots for Wireless and I/O Expansion
- Wide Operating Temperature (-40°C to 70°C)
- EN50155 & E-Mark for Railway & In-vehicle Applications

1.5 Hardware Specification

System

Processor

- Onboard Intel® Core™ i3-6100U Processor (3M Cache, 2.30 GHz, 15W TDP)
- Onboard Intel® Core™ i5-6300U Processor (3M Cache, up to 3.00 GHz, 15W TDP)
- On board Intel® Core™ i7-6600U Processor (4M Cache, up to 3.40 GHz, 15W TDP)

Chipset

- SoC

BIOS

- AMI 8Mbit SPI BIOS

Memory

- 1x DDR4 260-pin SO-DIMM Socket, Support up to 32 GB (2133MHz, Un-buffered and Non-ECC type)

Graphics

- Integrated Intel® HD Graphics
- Three Independent Display

Audio

- Realtek® ALC888-GR
- High Definition Audio

I/O Interface

- 1x DVI-I Connector, Resolution 1920 x 1080
- 1x DisplayPort Connector, Resolution 3840 x 2160
- 2x GbE LAN (Support Wake-on-LAN, Teaming, Jumbo Frame, IEEE 1588v2 and PXE), RJ45
 - GbE1: Intel I210AT
 - GbE2: Intel I219LM
- 6x RS-232/422/485 with Auto Flow Control (Support 5V/12V), DB9
- 4x USB 3.0 (Type-A) & 2x USB 2.0 (Type-A)
- 1x PS/2, 6-Pin Mini-DIN Female Connector
- 8x Optical Isolated DIO (4x DI, 4x DO), 10-Pin Terminal Block Support 9~30V
- 1x Line-out, Phone Jack 3.5mm
- 1x Mic-in, Phone Jack 3.5mm
- 1x ATX Power On/Off Button
- 1x AT/ATX Mode Switch
- 1x Clear CMOS Switch
- 1x Remote Power On/Off Connector, 2-Pin Terminal Block

Storage

- 2x 2.5" SATA HDD/SSD Bay, Support RAID 0/1 (Gen3) (One Internal, One Front Accessible & Hot-swappable)
- 2x mSATA (shared by Mini-PCIe socket) (Gen2)

Expansion

- 1x CFM Interface for Cincoze CFM Modules
- 1x CMI Interfaces for Cincoze CMI Modules
- 2x Full-size Mini-PCIe Sockets for Wireless & I/O Expansion
- 1x SIM Socket

Other Function

- Support CFM (Control Function Module) Technology
- Support CMI (Combined Multiple I/O) Technology
- Support Instant Reboot Technology (0.2 sec)
- SuperCap Integrated for CMOS Battery Maintenance-free
- Watchdog Timer: Software Programmable Supports 1~255 sec. System Reset

Power Requirement

- Support AT/ATX Power Type
- Power Input Voltage 9~48VDC
- One 3-Pin Terminal Block Connector
- Optional Power Adapter AC/DC 12V/5A 60W or 24V/5A 120W

Physical

- Dimension (WxDxH): 203 x 142 x 66.8 mm
- Weight: 1.65 kg
- Extruded Aluminum with Heavy Duty Metal
- Support Wall / Side / DIN-RAIL / VESA Mounting
- Fanless Design
- Cable-less Design
- Unibody Chassis
- Jumper-less Design

Protection

- Reverse Power Input Protection
- Over Voltage Protection: 58V
- Over Current Protection: 15A
- ESD Protection: +/-15kV (air), +/-8kV (contact)
- Surge Protection: 3kW

MTBF

- Time: 360,145 Hours
- Calculation Model: Telcordia SR-332 Issue 3, Method 1, Case 3
- Environment: GB, GC
- Temperature: 40°C

Operating System

- Windows® 10
- Windows® 8.1
- Windows® 7

Environment

- Operating Temperature: -40°C to 70°C
(With extended temperature peripherals; Ambient with air flow; According to IEC60068-2-1, IEC60068-2-2, IEC60068-2-14)
- Storage Temperature: -40°C to 85°C
- Relative Humidity: 95% RH @ 40°C (Non-condensing)
- Shock: Operating, 50 Grms, Half-sine 11 ms Duration (w/ SSD, according to IEC60068-2-27)
- Vibration: Operating, 5 Grms, 5-500 Hz, 3 Axes (w/ SSD, according to IEC60068-2-64)
- EMC: CE, FCC Class A
- Railway: EN50155, EN50121-3-2
- In-vehicle: E-Mark (E13, No.10R-0514273) Certified

1.6 System I/O

1.6.1 Front

ATX Power On/Off Button

Press to power-on or power-off the system

AT/ATX Mode Select Switch

Used to select AT or ATX power mode

Power LED

Indicates the power status of the system

HDD LED

Indicates the status of the hard drive

USB 2.0 Port

Used to connect USB 2.0/1.1 device

SIM Card Slot

Used to inserts a SIM card

IGN Setting Switch

Used to set up IGN function

Clear CMOS Switch

Used to clear CMOS to reset BIOS

Removable 2.5" SATA HDD/SSD Bay

Used to inserts a 2.5" HDD/SSD

Mic-in

Used to connect a microphone

Line-out

Used to connect a speaker

COM Port

COM #3 ~ COM #6 support RS232/422/485 serial device

Remote Power On/Off Terminal Block

Used to plug a remote power on/off terminal block

Universal I/O Bracket

Used to customized I/O output with optional modules

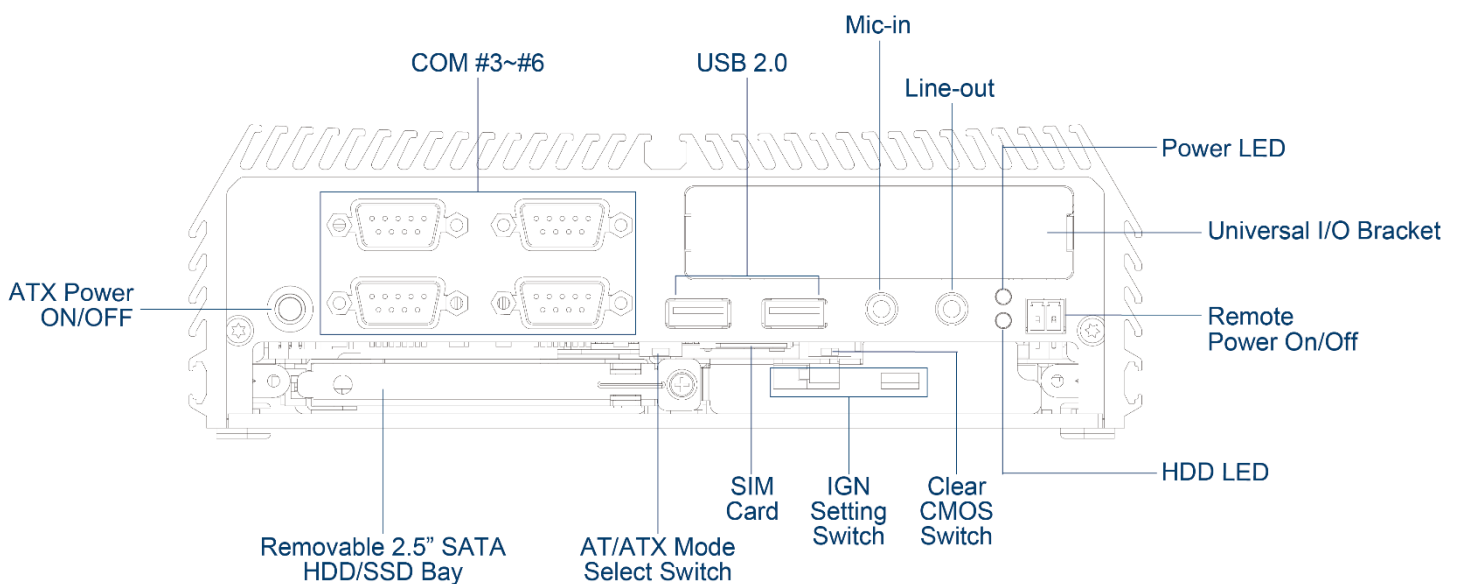

1.6.2 Rear

DC IN Terminal Block

Used to plug a DC power input with terminal block

DVI-I Port

Used to connect a DVI monitor or connect optional split cable for dual display mode

DisplayPort Port

Used to connect the system with DisplayPort monitor

PS/2 Port

Used to connect the PS/2 device

LAN Port

Used to connect the system to a local area network

USB 3.0 Port

Used to connect USB 3.0/2.0/1.1 device

COM Port

COM #1 ~ COM #2 support RS232/422/485 serial device

Digital I/O Terminal Block

The Digital I/O terminal block supports 4 digital input and 4 digital output

Antenna Hole

Used to install an antenna jack

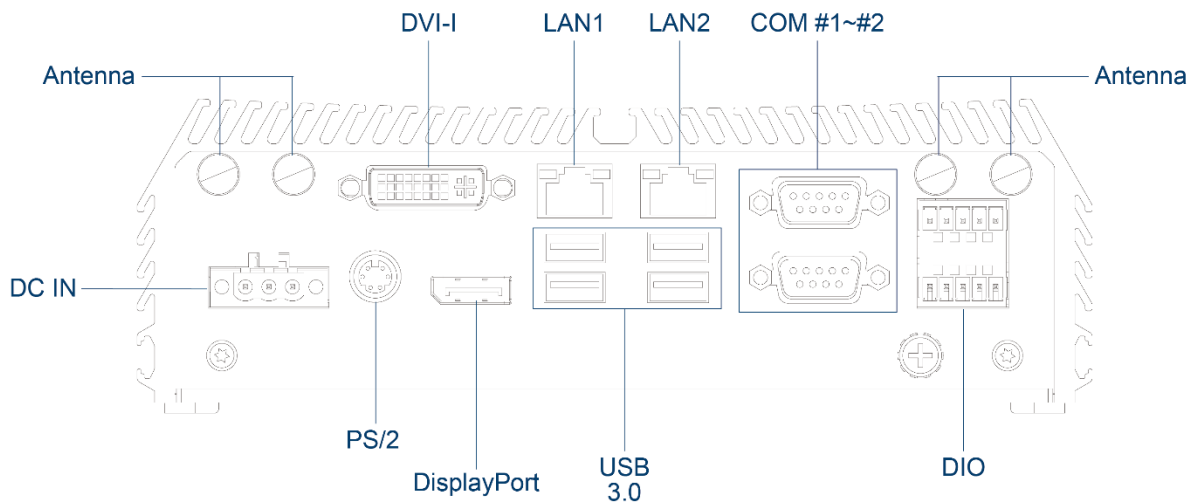

1.7 Mechanical Dimension

Unit: mm

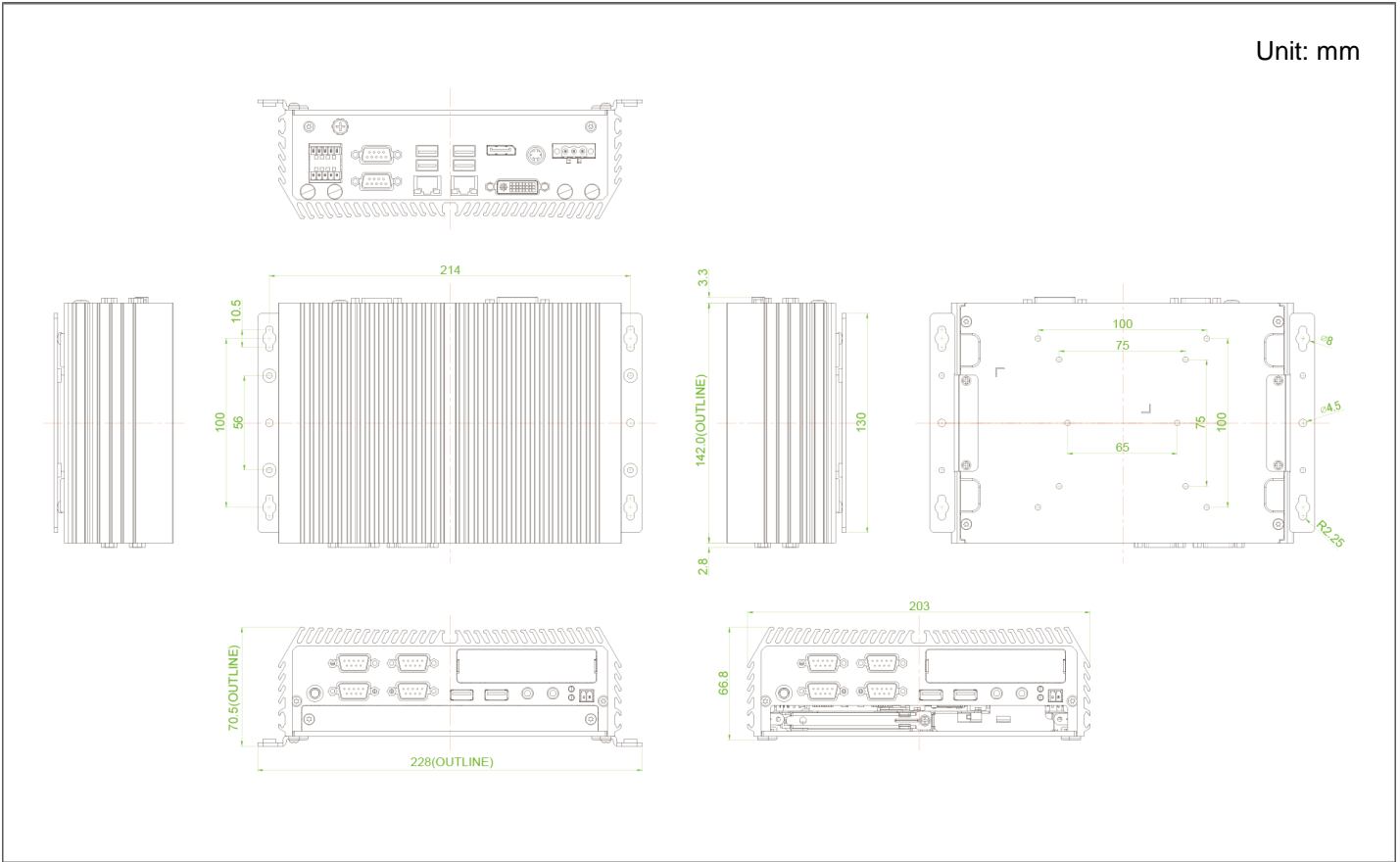



Chapter 2

System Pin Definitions and Settings

2.1 Settings

When setting the jumpers, ensure that the jumper caps are placed on the correct pins. When the jumper cap is placed on both pins, the jumper is **short**. If you remove the jumper cap, or place the jumper cap on just one pin, the jumper is **open**. Refer to below for examples of the 2-pin and 3-pin jumpers when they are short (on) and open (off).

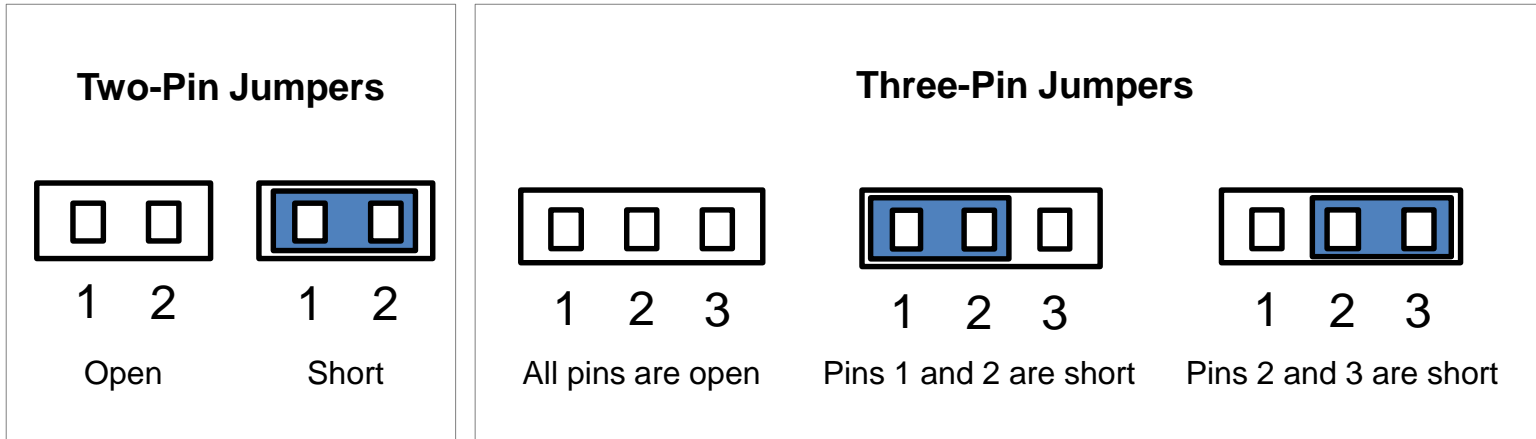

2.2 Location of the Connectors, Jumpers and Switches

2.2.1 Top View

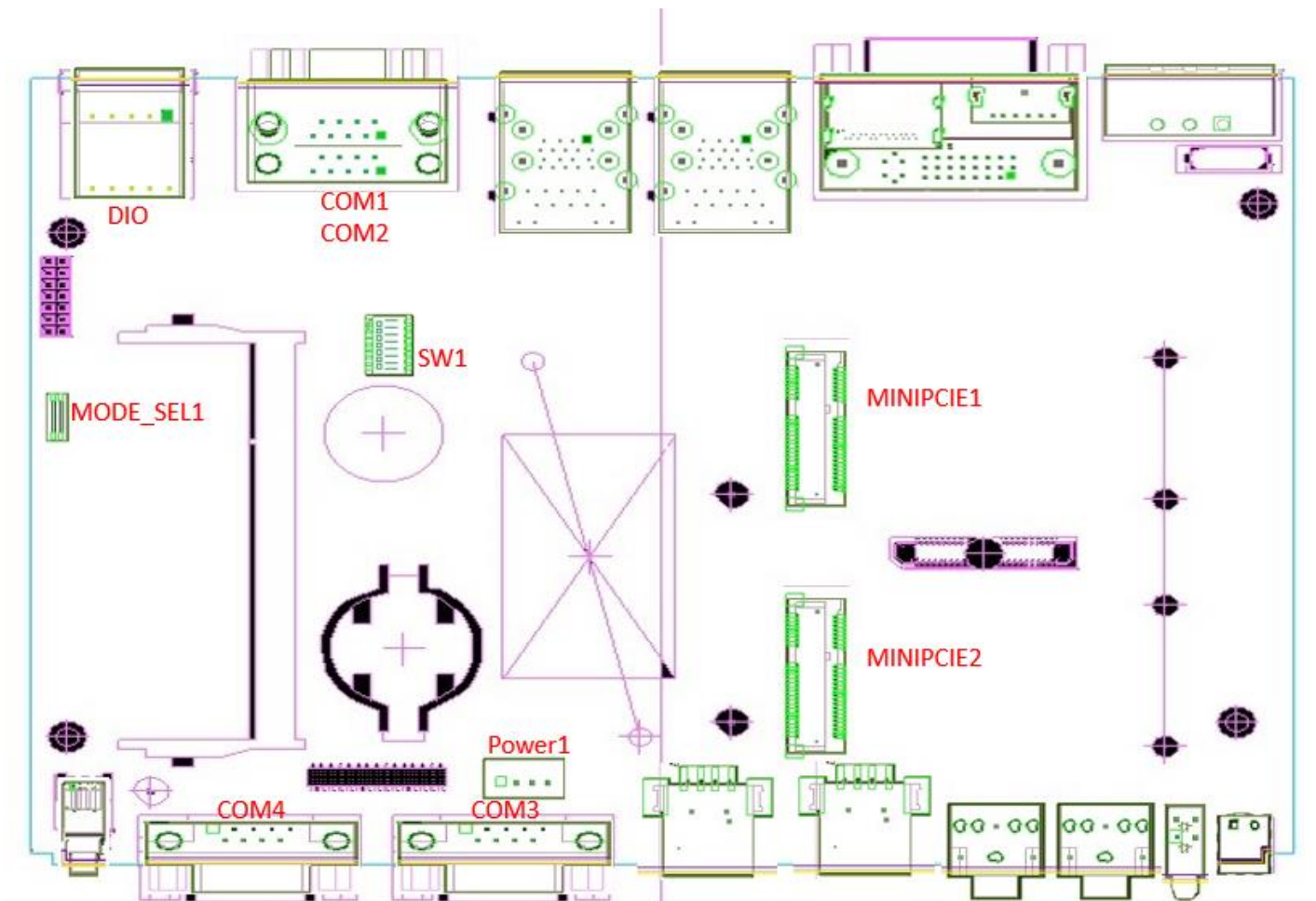

2.2.2 Bottom View

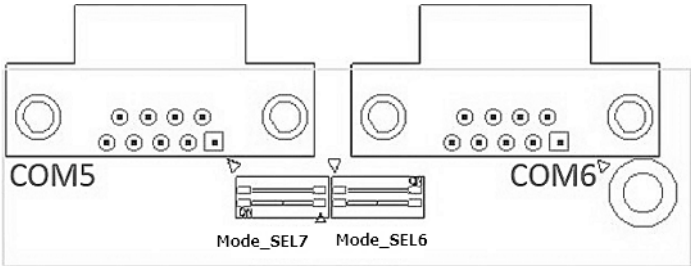
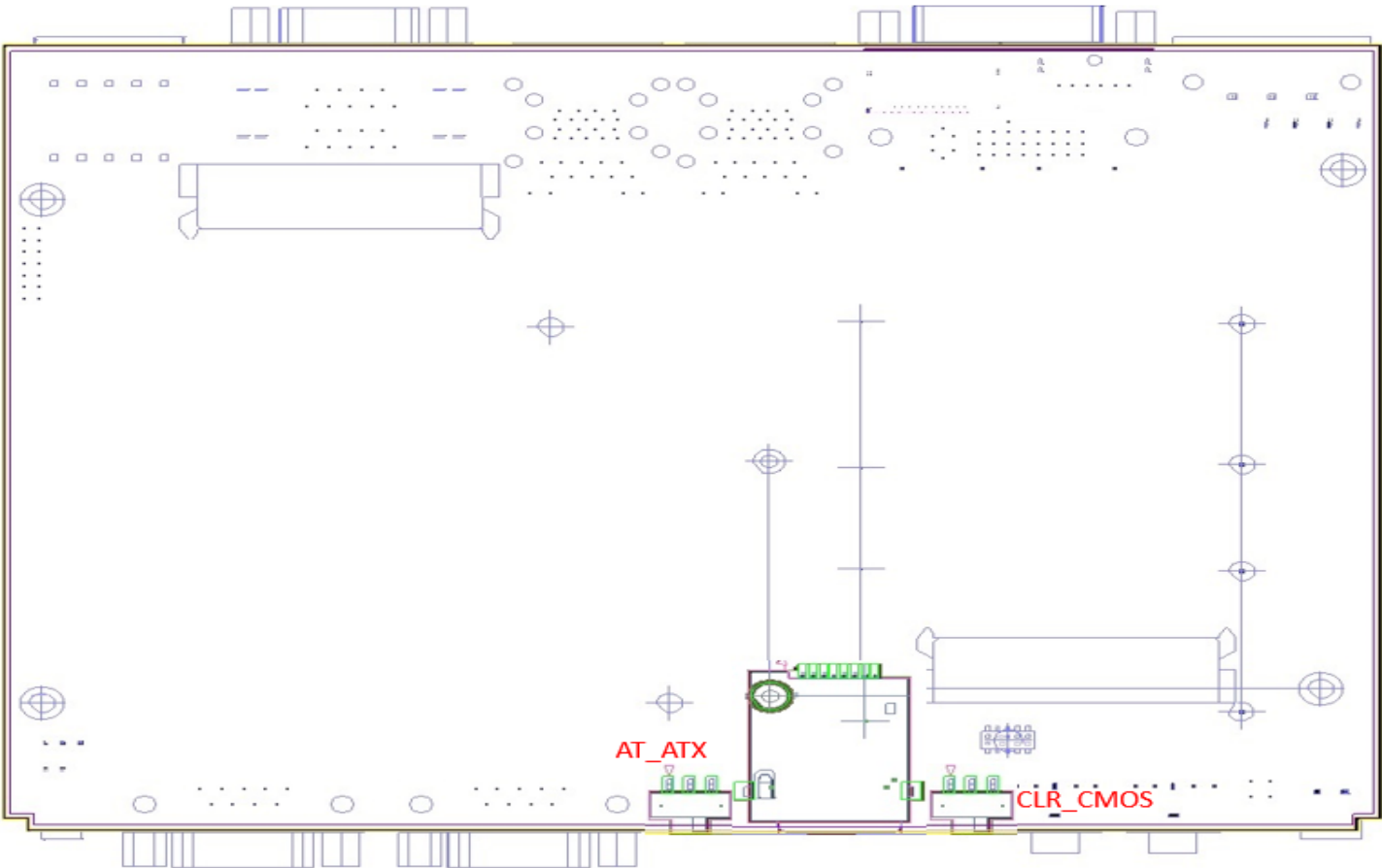

2.3 Connector / Jumper / Switch Definition

List of Connector / Jumper / Switch

Connector Location	Definition
SW1	COM1~4 with Power Select
MODE_SEL1	Super CAP for RTC
MODE_SEL6	COM6 with Power Select
MODE_SEL7	COM5 with Power Select
COM1, COM2	RS232/ RS422/ RS485 Connector
COM3, COM4	RS232/ RS422/ RS485 Connector
COM5, COM6	RS232/ RS422/ RS485 Connector
MINIPCIE1	Mini PCI-Express Socket/ MSATA Select Socket
MINIPCIE2	Mini PCI-Express Socket/ MSATA Select Socket
POWER1	+5V/ +12V Power Output
AT_ATX1	AT/ ATX Power Mode Switch
CLR_CMOS	Clear RTC reset switch

2.4 Definition of Switches

SW1 Pin Defined: COM1 / COM2 / COM3 / COM4 Power Select
COM1/2/3/4 Voltage Function Setting : Pin Define Switch

Location	Function		DIP1	DIP2
SW1	COM1	0V(RI)	ON (Default)	ON (Default)
		5V	ON	OFF
		12V	OFF	OFF
Location	Function		DIP3	DIP4
SW1	COM2	0V(RI)	ON (Default)	ON (Default)
		5V	ON	OFF
		12V	OFF	OFF
Location	Function		DIP5	DIP6
SW1	COM3	0V(RI)	ON (Default)	ON (Default)
		5V	ON	OFF
		12V	OFF	OFF
Location	Function		DIP7	DIP8
SW1	COM4	0V(RI)	ON (Default)	ON (Default)
		5V	ON	OFF
		12V	OFF	OFF

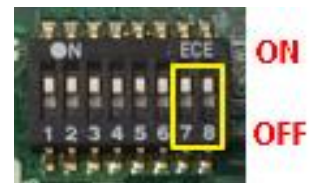
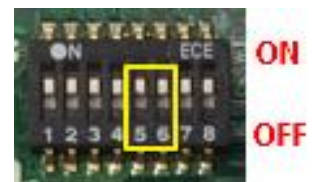
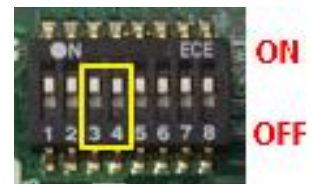
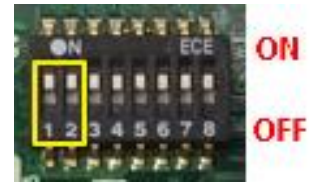

MODE_SEL6 / MODE_SEL7 Pin Defined: COM6 / COM5 Power Select
COM5/6 Voltage Function Setting : Pin Define Switch

Location	Function		DIP1	DIP2
Model SEL 6	COM6	0V(RI)	ON (Default)	ON (Default)
		5V	OFF	ON
		12V	OFF	OFF
Location	Function		DIP1	DIP2
Model SEL 7	COM5	0V(RI)	ON (Default)	ON (Default)
		5V	OFF	ON
		12V	OFF	OFF



MODE_SEL1 Pin Defined: RTC

Super CAP Function Setting: Pin Define MODE_SEL1 Switch

Switch mode	Function	ON	OFF
1	Super CAP	Enable (Default)	Disable
2	N/A	N/A	N/A

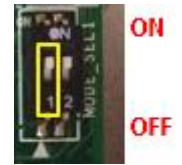

AT_ATX1: AT / ATX Power Mode Switch

Pin	Definition
1-2 (Left)	ATX Power Mode (Default)
2-3 (Right)	AT Power Mode

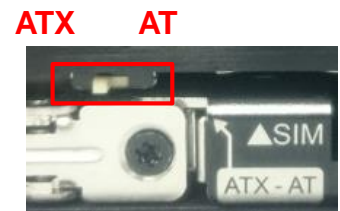

CLR_CMOS: Clear CMOS Switch

Pin	Definition
1-2 (Left)	Normal Status (Default)
2-3 (Right)	Clear CMOS



2.5 Definition of Connectors

MINIPCI-E1: Mini PCI-Express Socket (Support mSATA feature)

Pin	Definition	Pin	Definition	Pin	Definition
1	WAKE#	19	NA	37	RESERVED
2	3.3V	20	3.3V	38	USB_D+
3	NA	21	GND	39	3.3V
4	GND	22	PERST#	40	GND
5	NA	23	PERN0/SATARP0	41	3.3V
6	1.5V	24	3.3V	42	NA
7	CLKREQ#	25	PERP0/SATARN0	43	GND
8	RESERVED	26	GND	44	NA
9	GND	27	GND	45	NA
10	NA	28	+1.5V	46	NA
11	REFCLK-	29	GND	47	NA
12	NA	30	SMB_CLK	48	+1.5V
13	REFCLK+	31	PETN0/SATATN0	49	NA
14	NA	32	SMB_DATA	50	GND
15	GND	33	PETP0/SATATP0	51	NA
16	NA	34	GND	52	+3.3V
17	NA	35	GND		
18	GND	36	USB_D-		

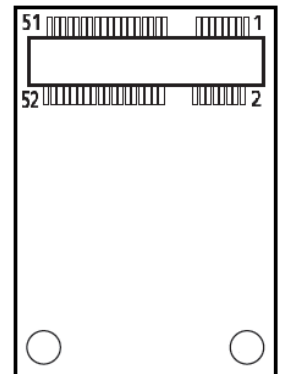

MINIPCE2: Mini PCI-Express Socket (Support mSATA and SIM Card to Link feature)

Pin	Definition	Pin	Definition	Pin	Definition
1	WAKE#	19	NA	37	GND
2	3.3V	20	3.3V	38	USB_D+
3	NA	21	GND	39	3.3V
4	GND	22	PERST#	40	GND
5	NA	23	PERN1/SATARP1	41	3.3V
6	1.5V	24	3.3V	42	NA
7	CLKREQ#	25	PERP1/SATARN1	43	GND
8	SIM_PWR	26	GND	44	NA
9	GND	27	GND	45	NA
10	SIM_DATA	28	+1.5V	46	NA
11	REFCLK-	29	GND	47	NA
12	SIM_CLK	30	SMB_CLK	48	+1.5V
13	REFCLK+	31	PETN1/SATATN1	49	NA
14	SIM_RESET	32	SMB_DATA	50	GND
15	GND	33	PETP1/SATATP1	51	NA
16	SIM_VPP	34	GND	52	+3.3V
17	NA	35	GND		
18	GND	36	USB_D-		

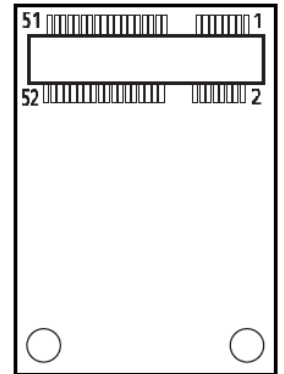

LED1: Power / HDD Access LED Status

LED1	LED Color
POWER	Green
HDD	Yellow



LAN LED Status Definition

Act LED Status	Definition
Blinking Yellow	Data Activity
Off	No Activity

Link LED Status	Definition
Steady Green	1Gbps Network Link
Steady Orange	100Mbps Network Link
Off	10Mbps Network Link

DC_IN1: DC Power Input Connector (+9~48V)

Connector Type: Terminal Block 1x3 3-pin, 5.0mm pitch

Pin	Definition
1	+9~48VIN
2	Ignition(IGN)
3	GND

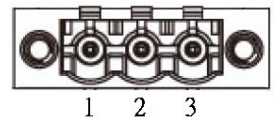

PWR_SW2: Power On/Off, SW Switch

Pin	Definition
1	GND
2	PWR_SW



(Note: Please do not apply power to the pins. This port is used to connect a switch.)

POWER1: Power Connector

Connector Type: 1X4-pin Wafer, 2.0mm pitch

Pin	Definition
1	+5V
2	GND
3	GND
4	+12V

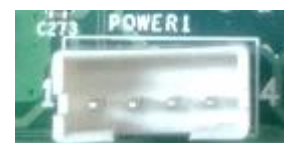

COM1/2/3/4/5/6: RS232 / RS422 / RS485 Connector

Connector Type: 9-pin D-Sub

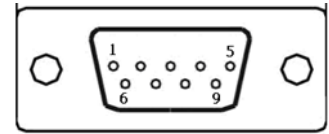

COM1/COM2/COM3/COM4/COM5/COM6			
DB9 Pin	RS232 Definition	RS422 / 485 Full Duplex Definition	RS485 Half Duplex Definition
1	DCD	TX-	DATA-
2	RXD	TX+	DATA+
3	TXD	RX+	
4	DTR	RX-	
5	GND		
6	DSR		
7	RTS		
8	CTS		
9	RI		

DIO: Digital Input / Output Connector

Connector Type: Terminal Block 2X5 10-pin, 3.5mm pitch

Pin	Definition	Pin	Definition
1	DI1	2	DO1
3	DI2	4	DO2
5	DI3	6	DO3
7	DI4	8	DO4
9	DC INPUT	10	GND

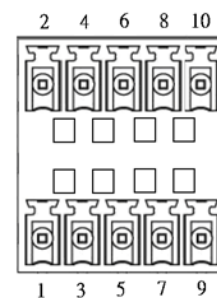



Chapter 3

Optional Module Pin Definitions and Settings

Optional High Speed CMI Module(CMI-M12LAN104/CMI-M12POE104)

Model No.	Description
CMI-M12LAN104/UB0710	CMI Module with M12 Connector, 4x Intel GbE LAN, 1x Universal Bracket
CMI-M12PoE114/UB0710	CMI Module with M12 Connector, 4x PoE+, Intel GbE LAN, Individual Port 25.5W, 1x Universal Bracket

3.1 CMI-M12LAN104 Connector

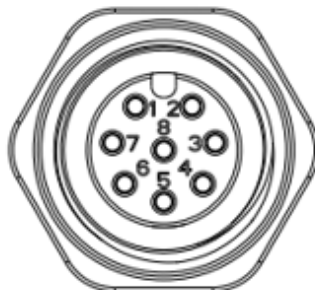

CMI-M12 LAN Module Pin Definitions

Connector Type: M12 A coded 8pin connector

Pin	Definition	Pin	Definition
1	2_LAN1_0+	2	2_LAN1_0-
3	2_LAN1_1+	4	2_LAN1_2+
5	2_LAN1_2-	6	2_LAN1_1-
7	2_LAN1_3+	8	2_LAN1_3-

3.2 CMI-M12POE114 Connector

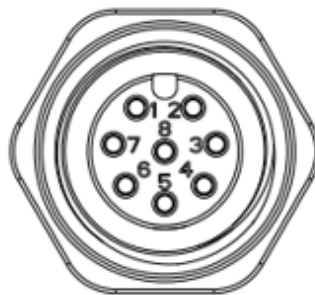

CMI-M12 PoE Module Pin Definitions

Connector Type: M12 A coded 8pin connector

POE type: Midspan (B-Type)

Pin	Definition	Pin	Definition
1	2_LAN1_0+	2	2_LAN1_0-
3	2_LAN1_1+	4	2_LAN1_2+(Power PIN)
5	2_LAN1_2-(Power PIN)	6	2_LAN1_1-
7	2_LAN1_3+(Power PIN)	8	2_LAN1_3-(Power PIN)

Optional CFM-IGN Power Ignition Module

Model No.	Description
CFM-IGN102	CFM Module with Power Ignition Sensing Control Function, 12V/24V Selectable

3.3 CFM-IGN Power Ignition Module Connector Location

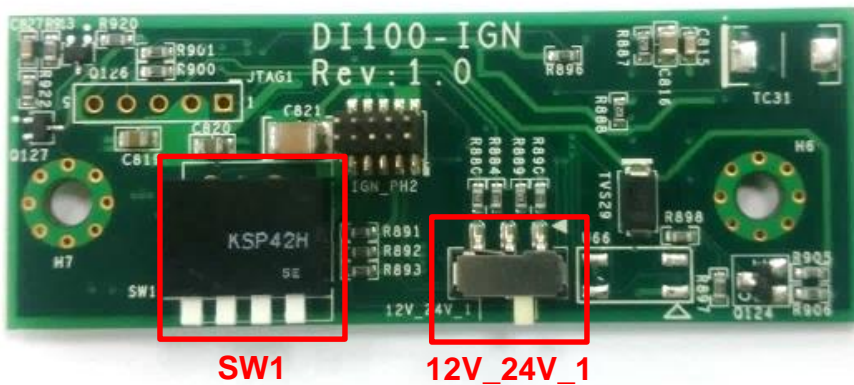

Connector Location	Definition
SW1	Power Ignition Function Setting
12V_24V_1	12V/ 24V Power Switch for Ignition Board

Definitions of Switches

12V_24V_1: 12V / 24V Car Battery Switch

Pin	Definition
1-2 (Right)	24V Car Battery Input
2-3 (Left)	12V Car Battery Input



SW1 (DIP 1): Enable or Disable power ignition function

DIP 1	Definition
ON	Enable Power Ignition Function
OFF	Disable Power Ignition Function

SW1 (DIP2~4): Set shutdown delay timer when ACC is turned off

DIP 2	DIP 3	DIP 4	Definition
ON	ON	ON	0 second
ON	ON	OFF	1 minute
ON	OFF	ON	5 minutes
ON	OFF	OFF	10 minutes
OFF	ON	ON	30 minutes
OFF	ON	OFF	1 hour
OFF	OFF	ON	2 hours
OFF	OFF	OFF	Reserved (0 second)

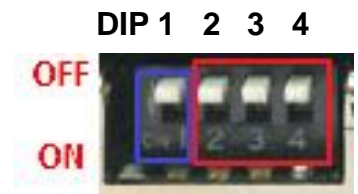



Chapter 4

System Setup

4.1 Disassembling the System for Installation



WARNING

In order to prevent electric shock or system damage, before removing the chassis cover, must turn off power and disconnect the unit from power source.

1. Turn over the unit to have the bottom side face up, loosen the 6 screws of bottom cover and place them aside for later use.

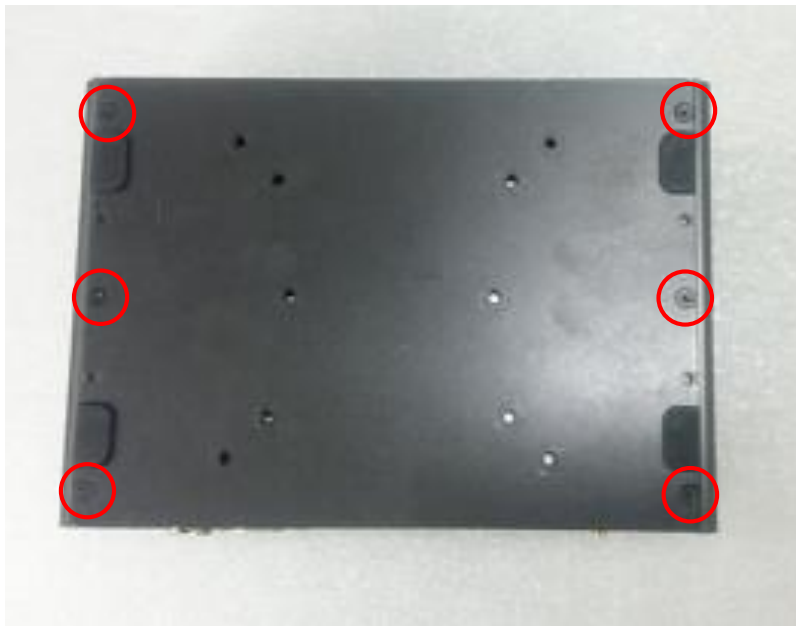

2. Remove the bottom cover from the chassis.



3. Hold front and rear panel and lift up the body of unit vertically.



4. Turn over the body of the unit and place it gently.



4.2 Installing Components on Top Side

4.2.1 Installing SO-DIMM Memory

1. Locate the SODIMM socket on the top side of system.



2. Insert a SO-DIMM module at a 45 degree angle until its edge connector is connected to SO-DIMM socket firmly.



3. Press down the module until the retaining clips snap back in place.



4.2.2 Installing a Mini-PCle/mSATA Card

1. Locate the Mini-PCle slot on the top side of system.

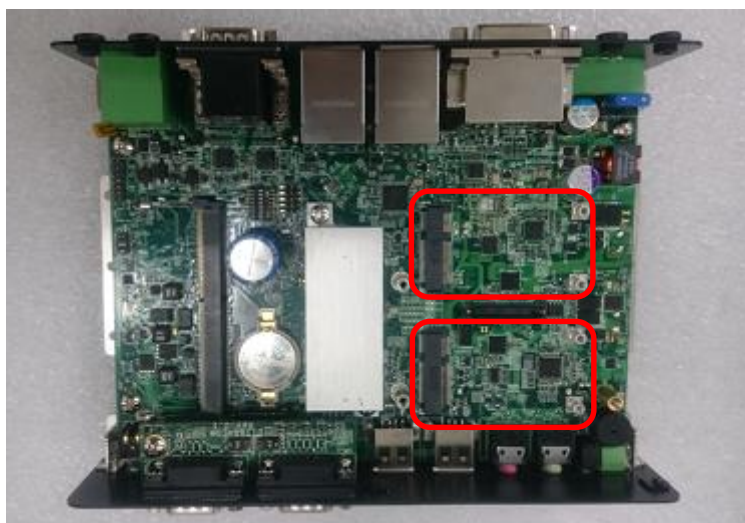

2. Insert the Mini-PCIe card at a 45 degree angle until its edge connector is connected firmly into slot. For 3G/4G Mini-PCIe card, please install on MINIPCIIE2 slot.



MINIPCIIE1 slot



MINIPCIIE2 slot

3. Press down the card and fasten two screws to fix it.



4.2.3 Installing Antennas



CAUTION

Please installing a Mini PCIe Wireless Lan Card on top side before you put on washer and fasten the nut with antenna jack.

1. Remove the antenna rubber covers on rear panel.



2. Penetrate the antenna jack through the hole at both sides as illustrated.



Caution: Installing an antenna jack greater than 9mm in diameter at left side of system will be colliding with DIO terminal block connector populated on DIO ports. For the case, please try to install the antenna at left side of system.

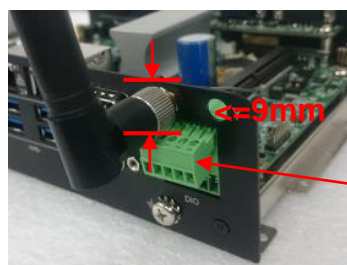

Terminal block connector on DIO ports

3. Put on washer and fasten the nut with antenna jack.



4. Assemble the antenna and antenna jack together

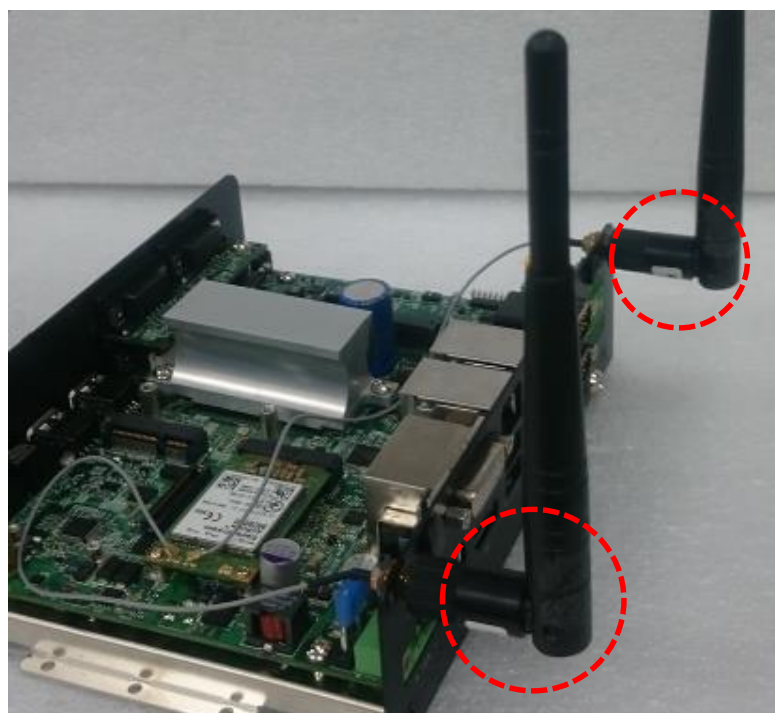

5. Attach the RF connector at another end of cable onto the module.



4.3 Installing Components on Bottom Side

4.3.1 Installing a SATA Hard Drive

1. Turn the unit to bottom side. Loosen 4 screws to remove the HDD bracket.

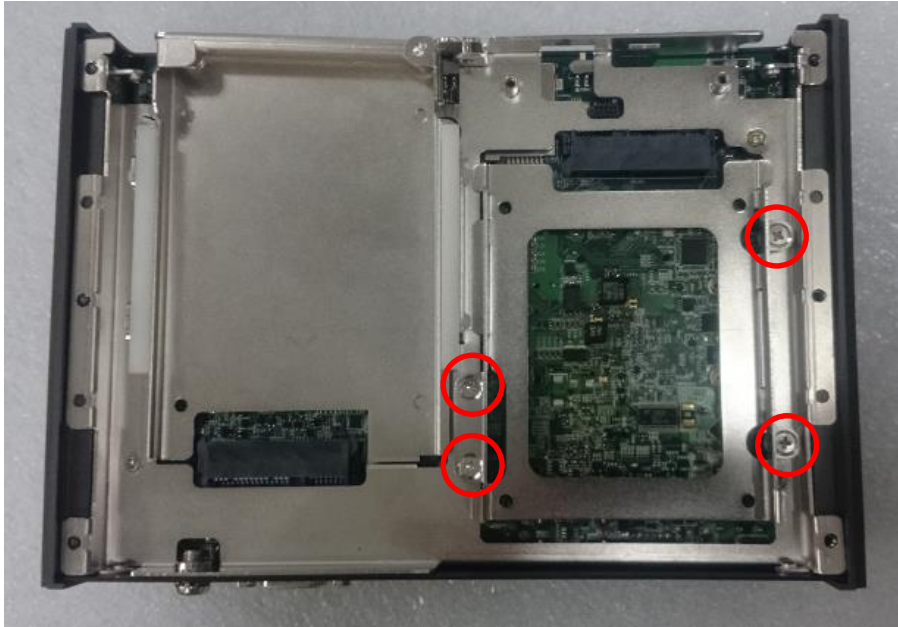

2. Make the bottom side of HDD face up, and place the HDD bracket on it. Ensure the direction of bracket is correct and use 4 provided screws to assemble HDD and HDD bracket together.



3. Turn over the HDD bracket assembly. Connect the HDD bracket to the SATA connector and fasten the 4 screws to fix it.



4.3.2 Installing a CFM-IGN Power Ignition Module

1. Locate the IGN connector on the bottom side of system.

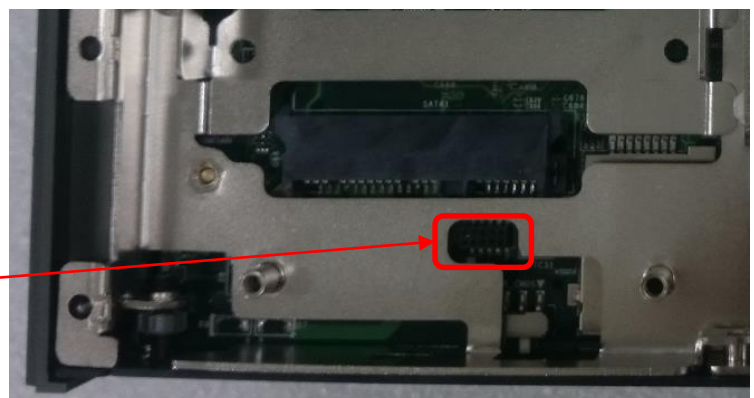
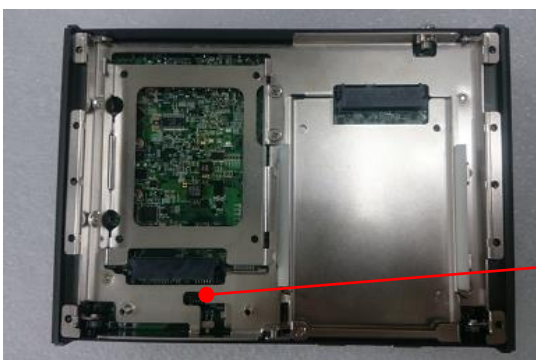

2. Insert IGN module vertically to the female connector on the system's mainboard, and fasten 2 screws to fix it.

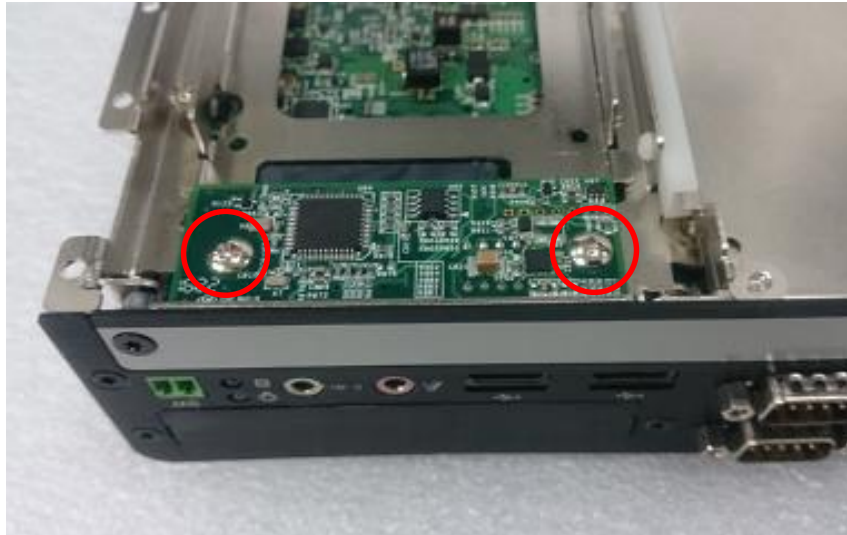

4.3.3 Installing a High Speed CMI Module

The applicable high speed CMI modules for DI-1000 series are listed in the following table.

Model No.	Description
CMI-LAN104/UB0712	CMI Module with 4x Intel GbE LAN, RJ45 Port, 1x Universal Bracket
CMI-PoE114/UB0712	CMI Module with 4x PoE+, Intel GbE LAN, RJ45 Port, Individual Port 25.5W, 1x Universal Bracket
CMI-M12LAN104/UB0710	CMI Module with M12 Connector, 4x Intel GbE LAN, 1x Universal Bracket
CMI-M12PoE114/UB0710	CMI Module with M12 Connector, 4x PoE+, Intel GbE LAN, Individual Port 25.5W, 1x Universal Bracket

Note: The photo example in this section is illustrated by [CMI-M12LAN104/UB0710](#) module as shown in below picture.

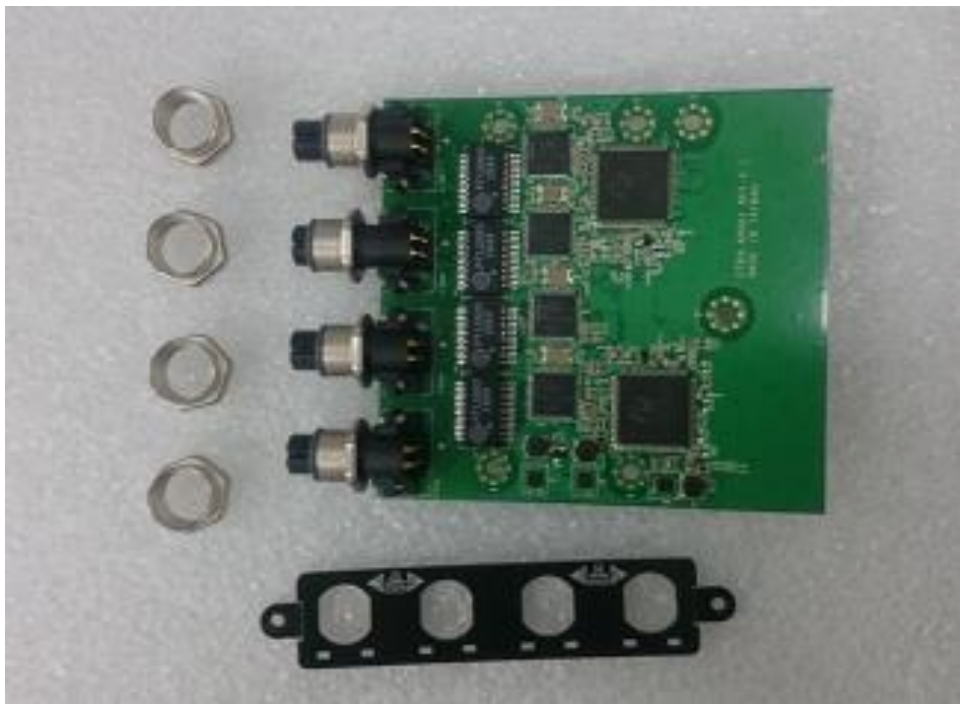

1. Loosen the 2 screws on front bezel to remove the cover plate.



2. Remove 4 rubber rings on M12 jacks; Penetrate M12 jacks of CMI module through the accompanying M12 I/O bracket. then fasten 4 ring hexes onto jacks as illustrated in right hand picture below.

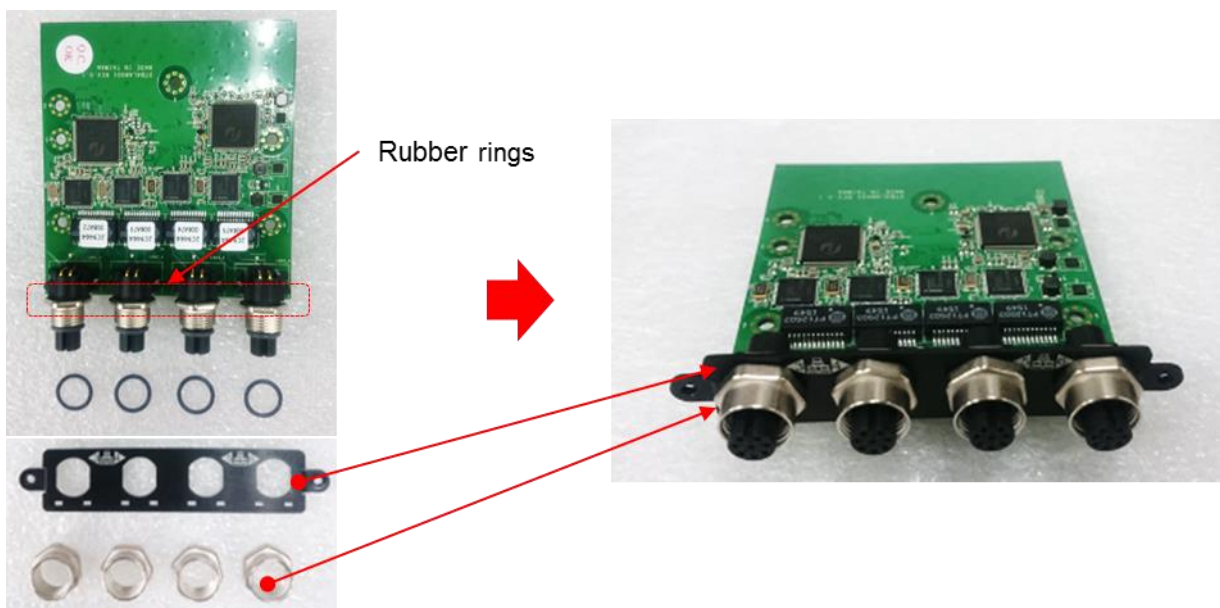

3. Locate the CMI connector on the top side of system.



4. Insert the CMI module vertically into the female connector on system's mainboard until it's connected firmly. Fasten 3 screws to fix it.

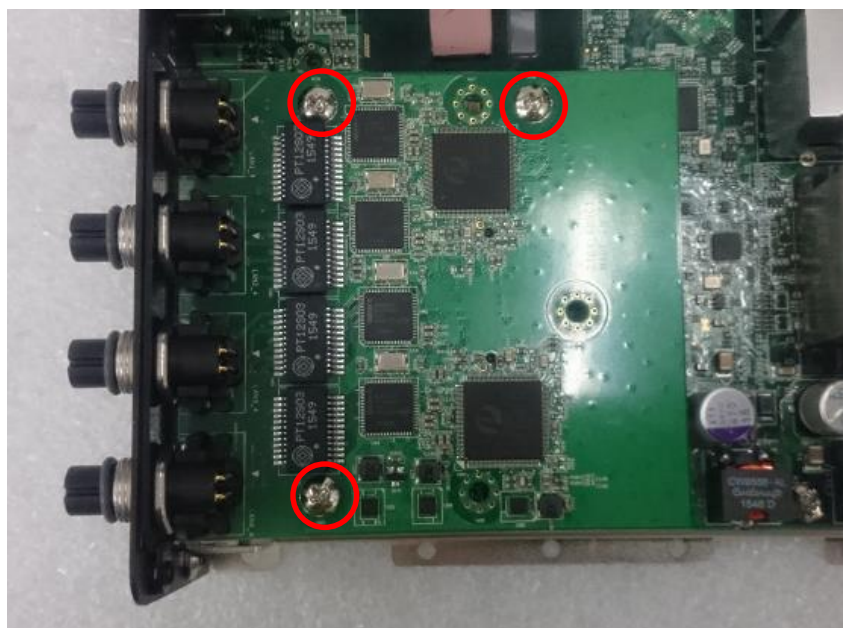

5. Fasten 2 screws on front bezel.



4.4 Assembling the System

4.4.1 Installing Thermal Pad

1. Please find the new thermal pad that is attached on the top cover of system.



2. Remove the protection sheet on the thermal pad.



Protection sheet

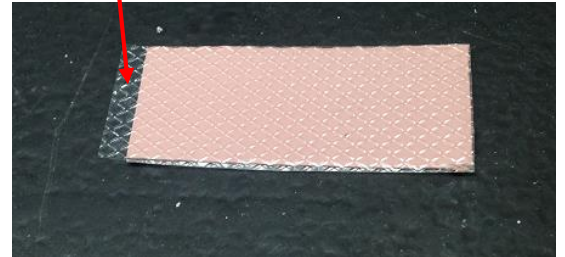

3. Please paste the thermal pad onto the heatsink carefully.

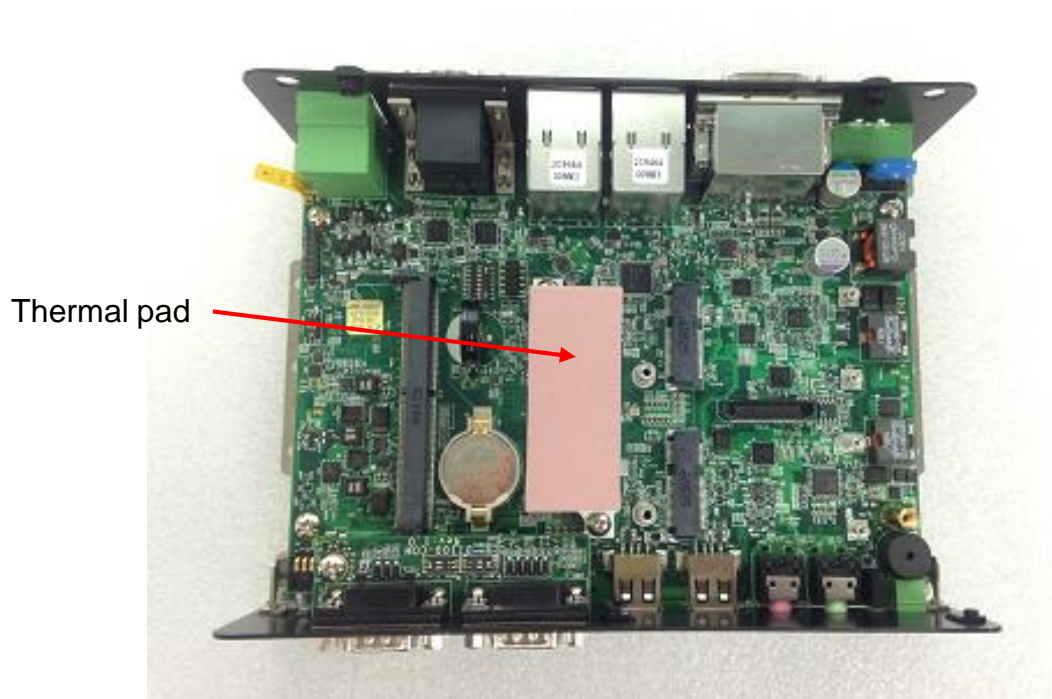

4.4.2 Installing Top Cover

1. Hold front and rear panel and put the body of unit back to chassis.

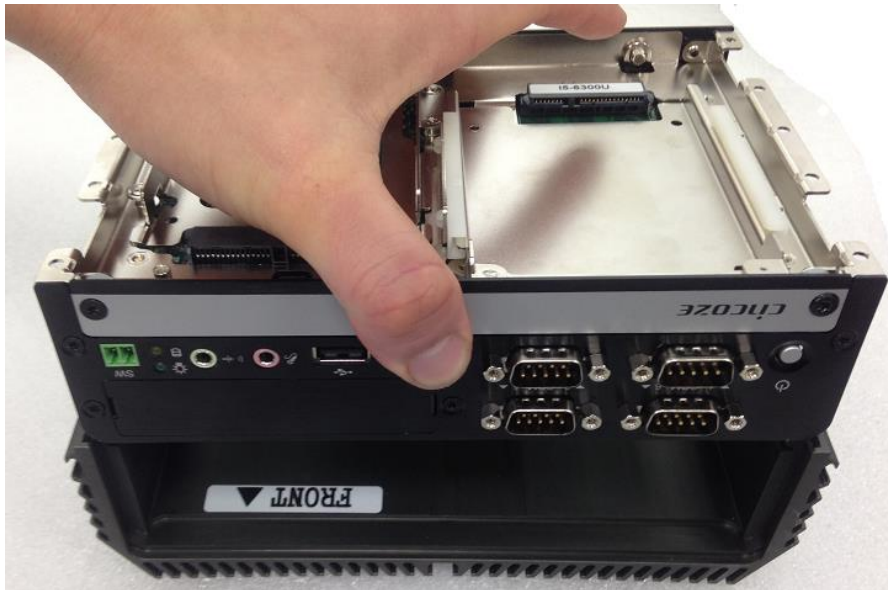

4.4.3 Installing Bottom Cover

1. Place the bottom cover back to system.



2. Fasten the bottom cover with 6 screws .

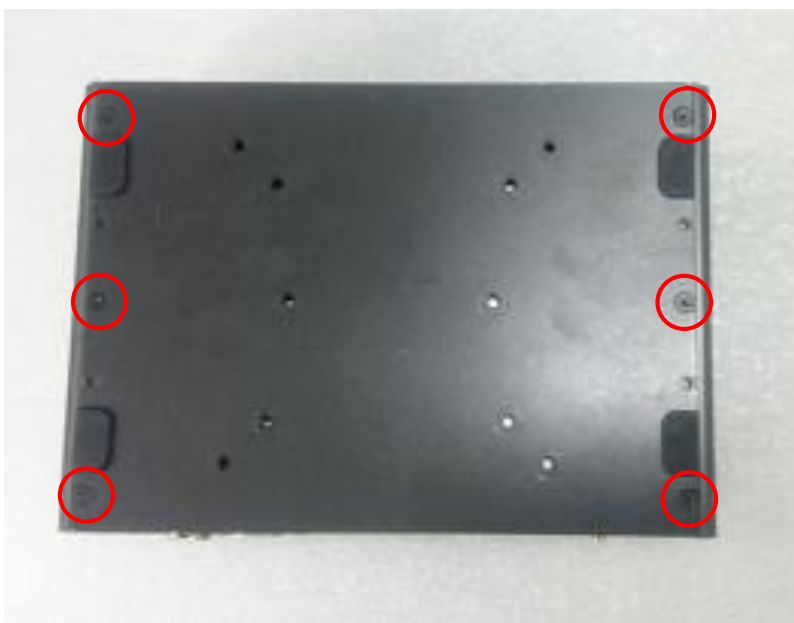

4.5 Installing Components at Front Side

4.5.1 Removing the Front Cover Plate

1. Loosen 2 screws on front panel to remove cover plate.

Note: It's advised to fasten the 2 screws manually. If fastened with an electrical screw driver, please set the torque of the driver to 2.5KgF.



4.5.2 Installing a SATA Hard Drive at Front Side

1. Locate the removable HDD bay and loosen the screw.



2. Pull the rotating arm and pull the HDD bracket out of system.



3. Make the bottom side of the HDD face up, place the HDD bracket on it. Ensure the direction of bracket is correct and use 4 provided screws to assemble HDD and HDD bracket together.

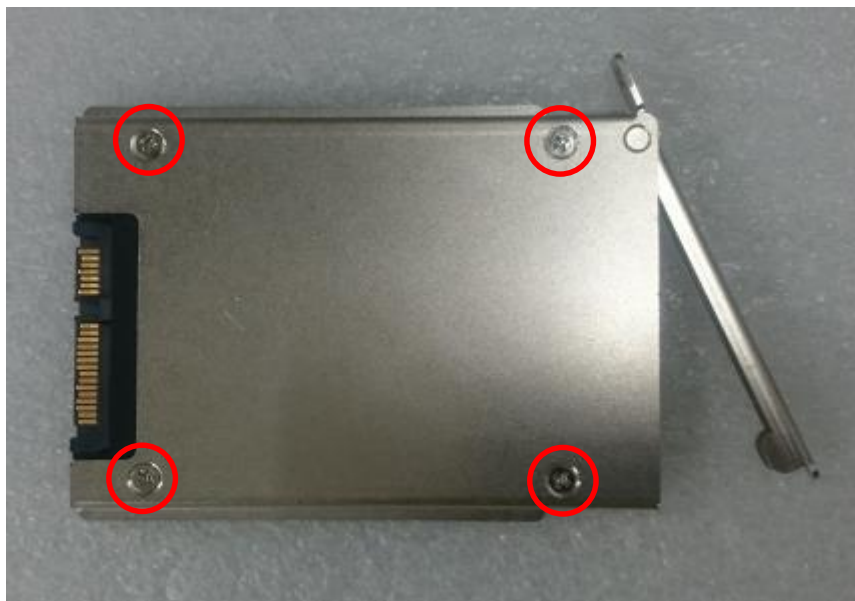

4. Align the HDD bracket assembly with the entrance of removable HDD bay. Holding the rotating arm and insert the HDD bracket until the connector of HDD contact the SATA connector firmly.



5. Place the rotating arm back and fasten the screw.



4.5.3 Installing a SIM Card

1. Locate the SIM card slot at front side.



2. Insert a SIM card into SIM slot with the gold contacts facing up. Please pay attention to the insert orientation as illustrated.



4.5.4 Installing the Front Cover Plate

1. Put the front cover plate back. Fasten it with 2 screws.



4.6 Wall Mount Brackets

DI-1000 series offers wall mount that customers can install system on the wall in convenient and economical ways.



1. The mounting holes are at the bottom side of system. Use provided 4 screws to fasten the bracket on each side.

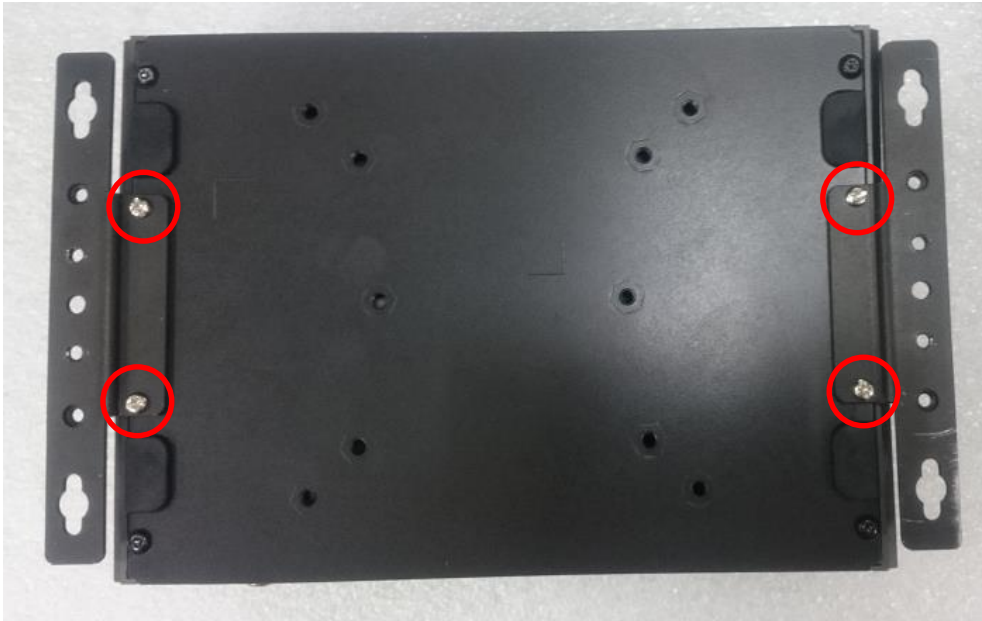

2. There are 2 bracket mounting holes at left and right side for customer fix the system on the wall.



4.7 DIN-Rail Mount Brackets

DI-1000 series offers DIN-Rail Mount that customer can install system on the DIN Rail.

1. Please refer to section 3.5 Wall Mount Brackets to install mounting bracket at both sides of system.

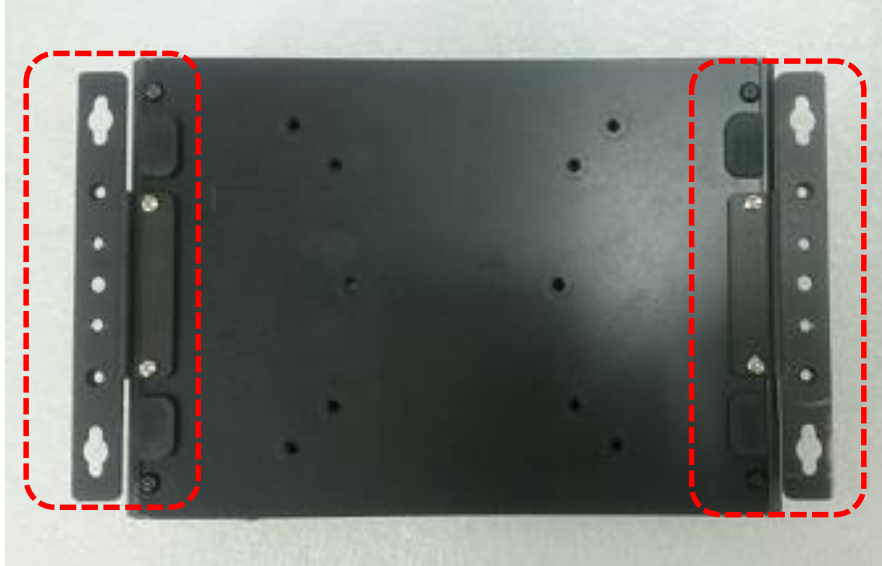

2. Fasten 2 DIN rail mounting clips to mounting brackets on both sides with provided 4 screws as illustrated.



3. Clip the system into DIN rail as illustrated by the following steps. (1) Have lower end of mounting clip snaps into the DIN rail. (2) Press the system toward to have upper end of mounting clip snaps into the other side of DIN rail.



4.8 VESA Mount

DI-1000 series supports VESA mounting that customer can mount system with panel complying with VESA 75mm and 100 mm standard for various usage.

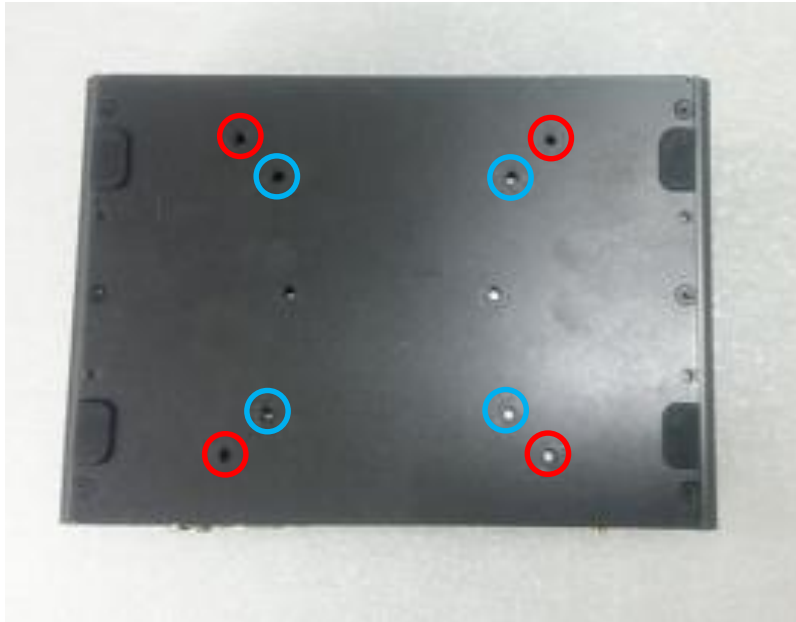

1. The following picture illustrates the installation of DI-1000 series on a VESA stand. Align the 4 screw holes of VESA stand with the screw holes on bottom side of system. Fasten 4 screws to fix it.

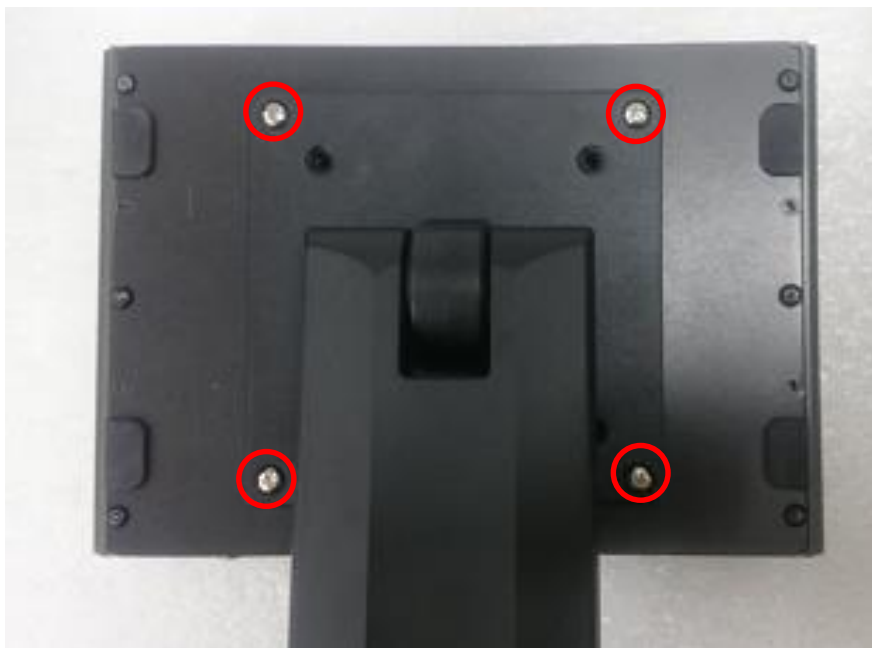

3. Provided below is mounted with VESA stand.



4.9 Side Mount Brackets

DI-1000 series offers Side Mount that customer can install system to the right or left side of wall to create effective of space.

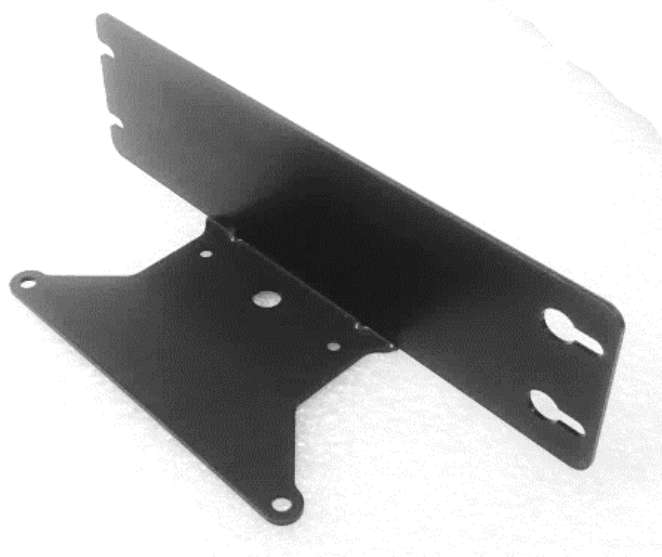

1. The mounting holes are at the bottom of system. Fasten the 4 screws to fix the side mount bracket with system together.

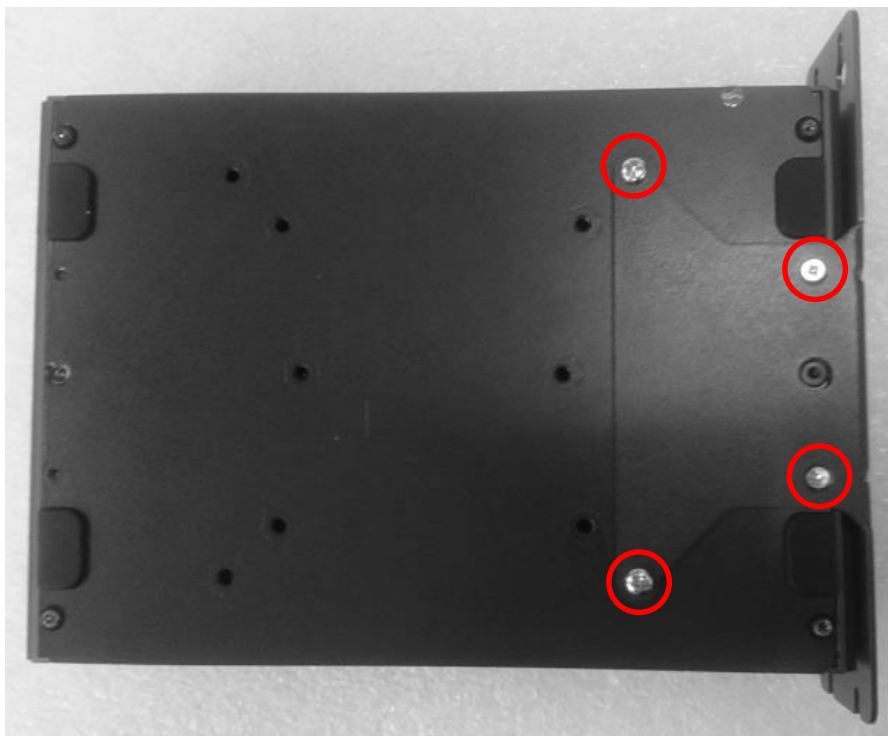

2. Fasten the screws through the bracket mounting hole to mount system on the wall.





Chapter 5

BIOS Setup

5.1 BIOS Introduction

The BIOS (Basic Input/Output System) is a program located on a Flash Memory on the motherboard. When you start the computer, the BIOS program will gain control. The BIOS first operates an auto-diagnostic test called POST (power on self test) for all the necessary hardware, it detects the entire hardware device and configures the parameters of the hardware synchronization.

BIOS Setup

Power on the computer and by pressing immediately allows you to enter Setup. If the message disappears before your respond and you still wish to enter Setup, restart the system to try again by turning it OFF then ON or pressing <Ctrl>, <Alt> and <Delete> keys.

Control Keys	
<←> <→>	Move to select screen
<↑> <↓>	Move to select item
<Esc>	Quit the BIOS Setup
<Enter>	Select item
<Page Up/+>	Increases the numeric value or makes changes
<Page Down/->	Decreases the numeric value or makes changes
<Tab>	Select setup fields
<F1>	General help
<F2>	Previous value
<F3>	Load Optimized defaults
<F10>	Save configuration and Exit

Main Menu

The main menu lists the setup functions you can make changes to. You can use the arrow keys (↑↓) to select the item. The on-line description of the highlighted setup function is displayed at the bottom of the screen.

Sub-Menu

If you find a right pointer symbol appears to the left of certain fields that means a sub-menu can be launched from this field. A sub-menu contains additional options for a field parameter. You can use arrow keys (↑↓) to highlight the field and press <Enter> to call up the sub-menu. Then you can use the control keys to enter values and move from field to field within a sub-menu. If you want to return to the main menu, just press the <Esc >.

5.2 Main Setup

Press key to enter BIOS CMOS Setup Utility, the Main Menu (as shown below) will appear on the screen. Use arrow keys to move among the items and press <Enter> to accept or enter a sub-menu.



5.2.1 System Date

Set the date. Please use <Tab> to switch between date elements.

5.2.2 System Time

Set the time. Please use <Tab> to switch between time elements.

5.3 Advanced Setup

This section allows you to configure and improve your system and allows you to set up some system features according to your preference.

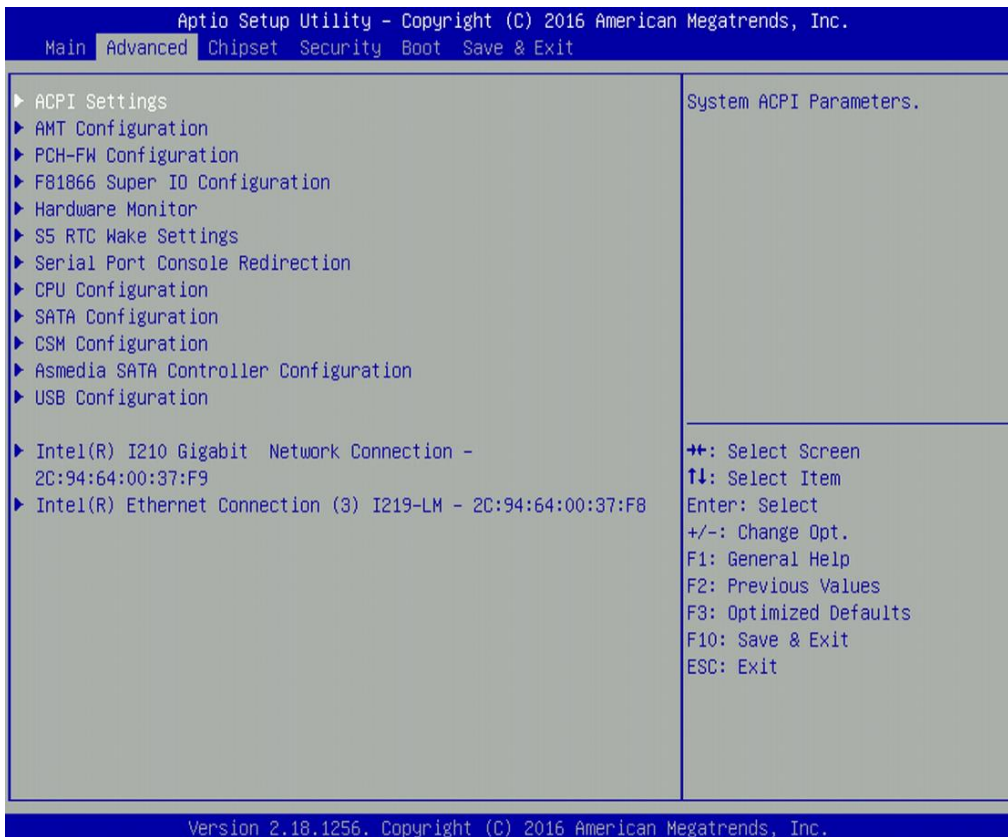

5.3.1 ACPI Settings

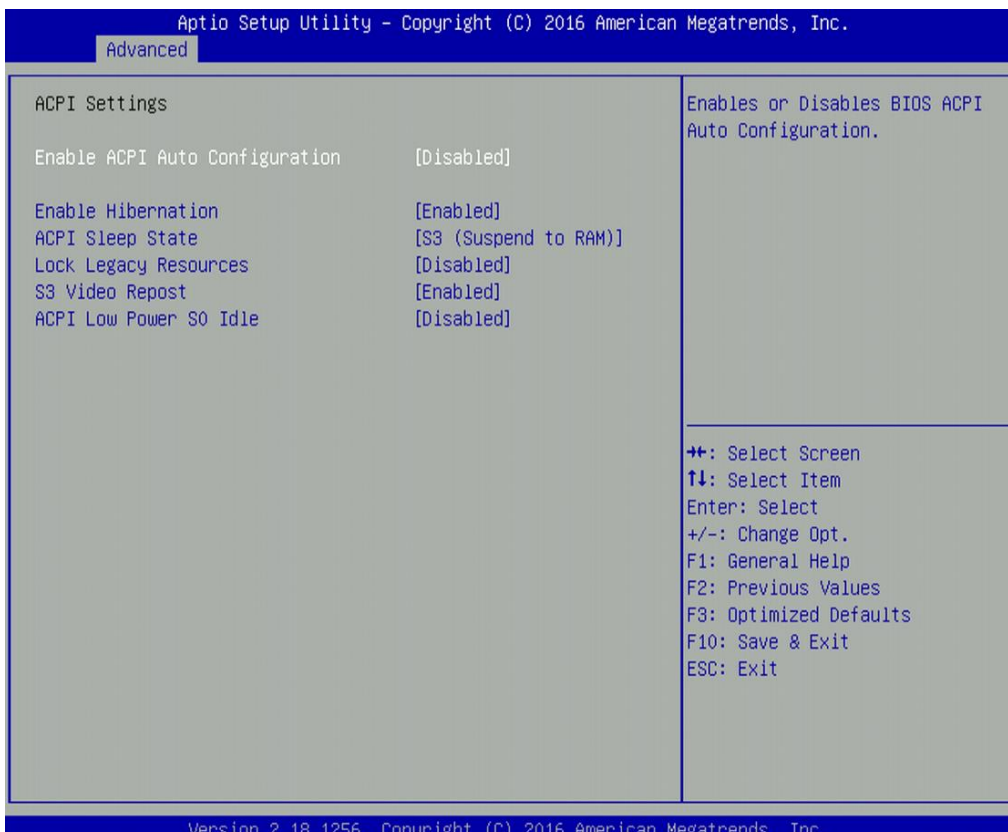

■ Enable ACPI Auto Configuration

Enables or disables BIOS Advanced Configuration Power Interface® (ACPI) auto configuration.

■ Enable Hibernation

Enables or disables system ability to hibernate state (OS/S4 state). This option may not be effective with some OS.

■ ACPI Sleep State

Allows you to select the highest Advanced Configuration Power Interface® (ACPI) sleep state that system will enter when suspend button is pressed.

[Suspend Disabled]: Disables entering suspend state.

[S3 (suspend to RAM)]: Enables suspend to RAM state.

■ Lock Legacy Resources

Enables or disables Lock Legacy Resources.

■ S3 Video Repost

Enable or disable S3 Video Repost.

■ ACPI Low Power S0 Idle

Enables or disables ACPI Low Power S0 idle support.

5.3.2 AMT Configuration

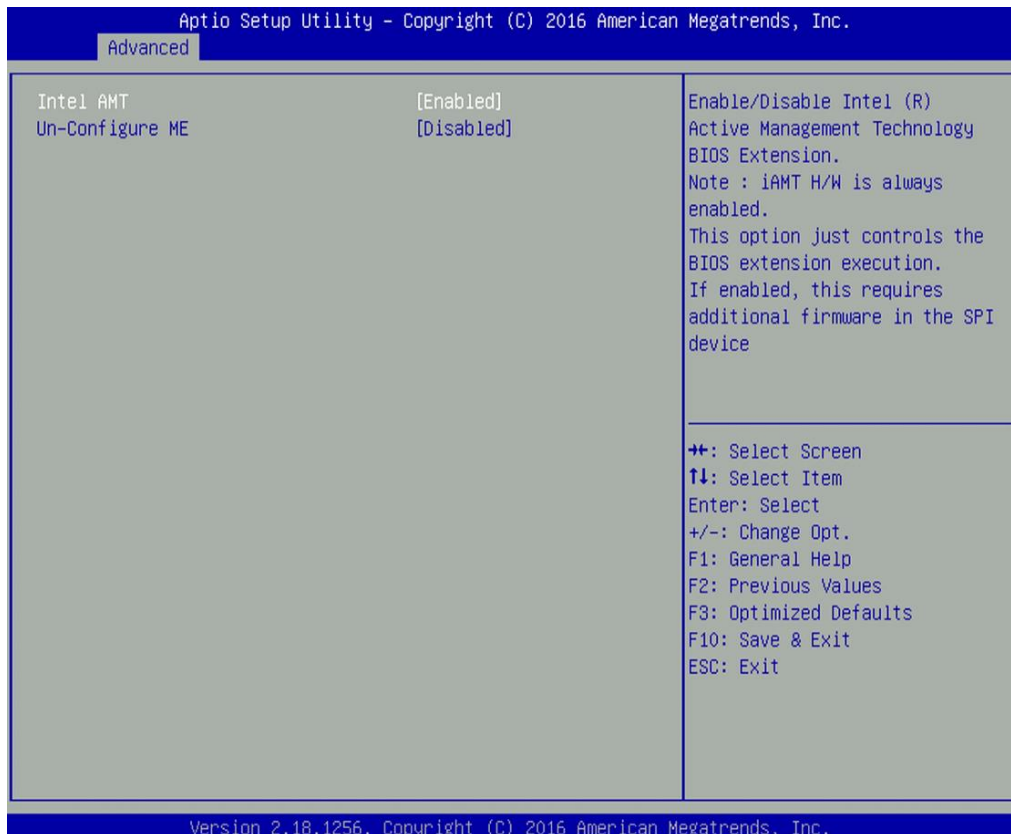
**■ Intel AMT**

Enables or disables Intel® Active Management Technology BIOS Extension.

■ Un-Configure ME

Enables or disables Un-Configure-Management Engine(ME) without password.

5.3.3 PCH-FW Configuration

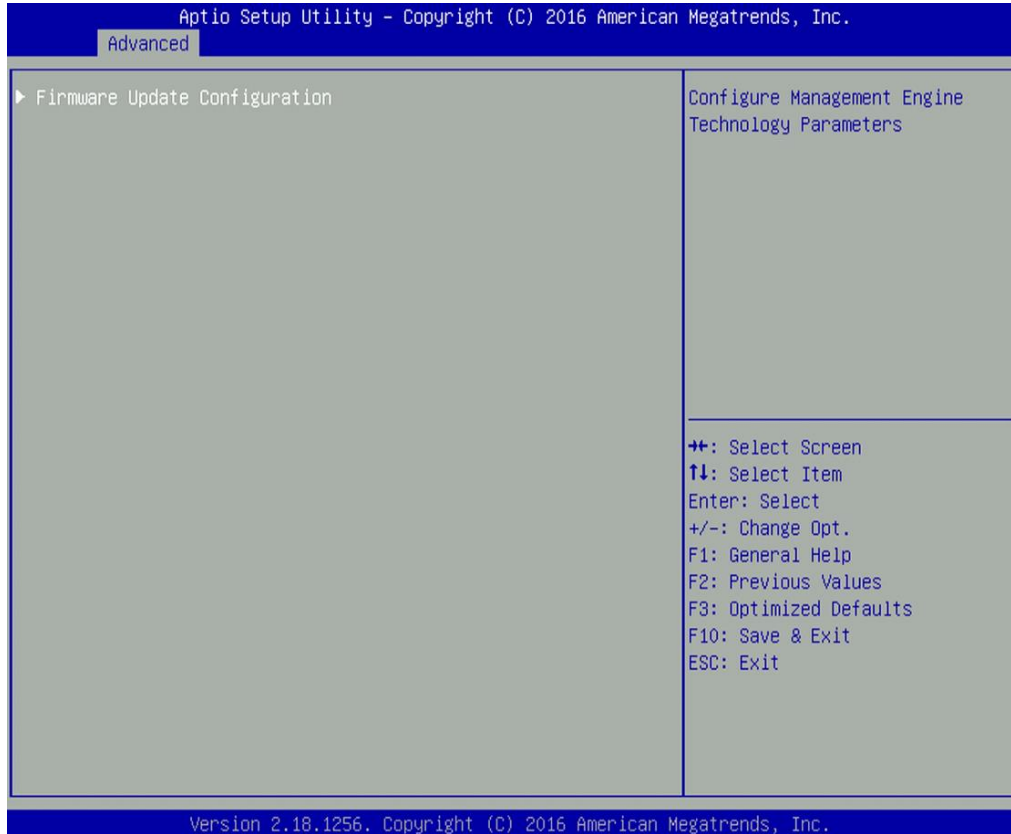

■ Firmware Update Configuration

Configure Management Engine Parameters

□ Me FW Image Re-Flash

Enables or disables ME firmware Image Re-Flash function.

5.3.4 F81866 Super IO Configuration

Set Parameters of Serial Ports. User can Enable/Disable the serial port and Select an optimal settings for the Super IO Device

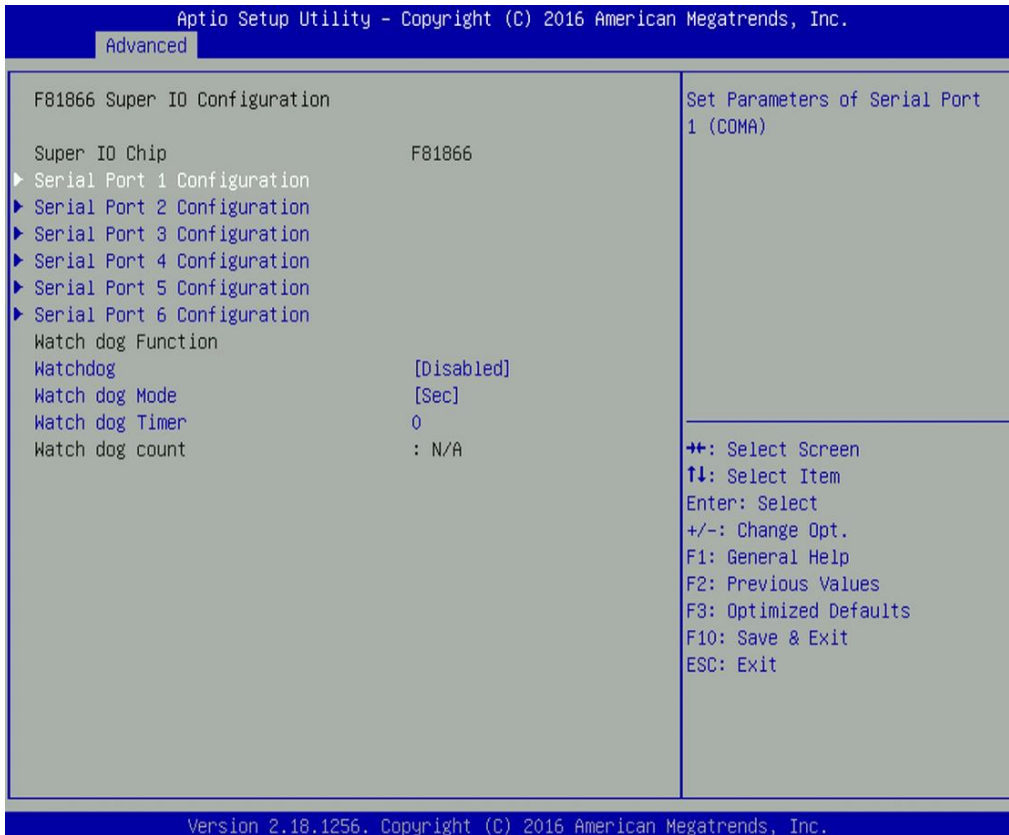

Serial Port 1~6 Configuration.



❑ Serial Port

Enables or disables serial port.

❑ Change Settings

Allows you to change the IO Address & IRQ settings of the specified serial port.

❑ Onboard Serial Port 1~6 Mode

Allows you to select Serial Port Mode.

Configuration options: [RS232] [RS422/RS485 Full Duplex] [RS485 Half Duplex]

Watch Dog Function

You can setup the system watch-dog timer, a hardware timer that generates a reset when the software that it monitors does not respond as expected each time the watch dog polls it.

■ Watch Dog

Enables or disables watch dog function.

■ Watch Dog Mode

Allows to set watchdog timer unit <Sec> or <Min>.

■ Watch Dog Timer

Allows you to set watchdog timer's value in the range of 0 to 255.

5.3.5 Hardware Monitor

This screen displays the current status of all monitored hardware devices/components such as voltages, temperatures and all fans' speeds.

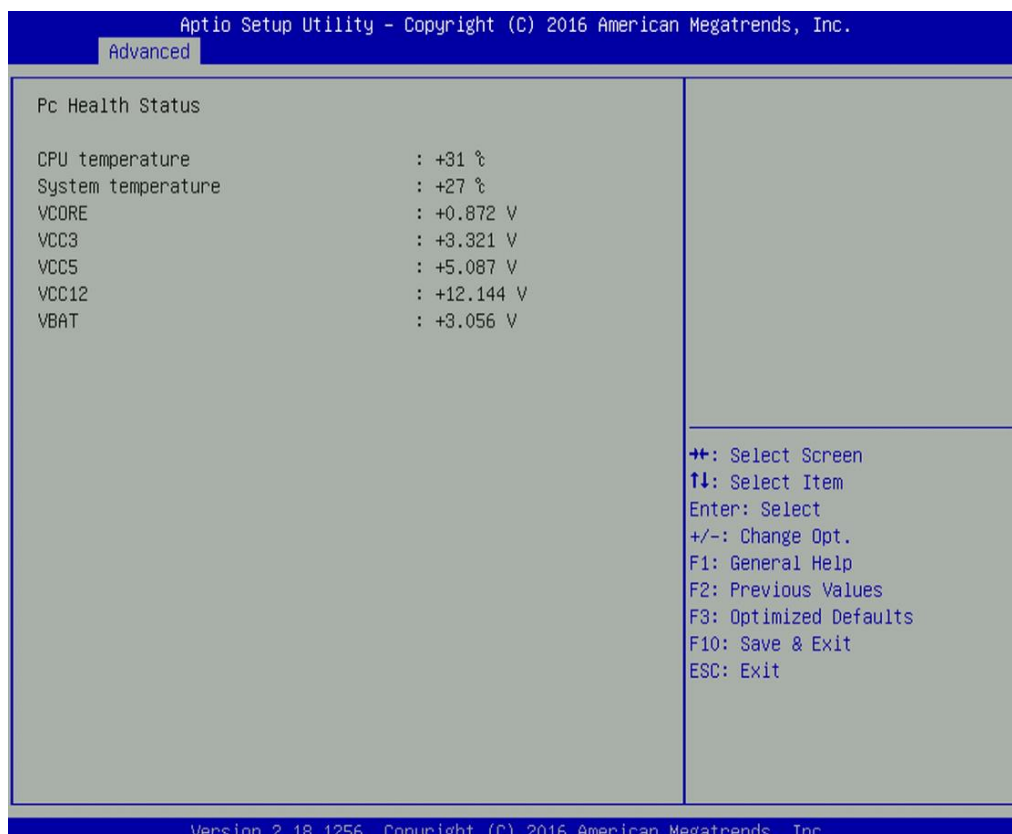

5.3.6 S5 RTC Wake Settings

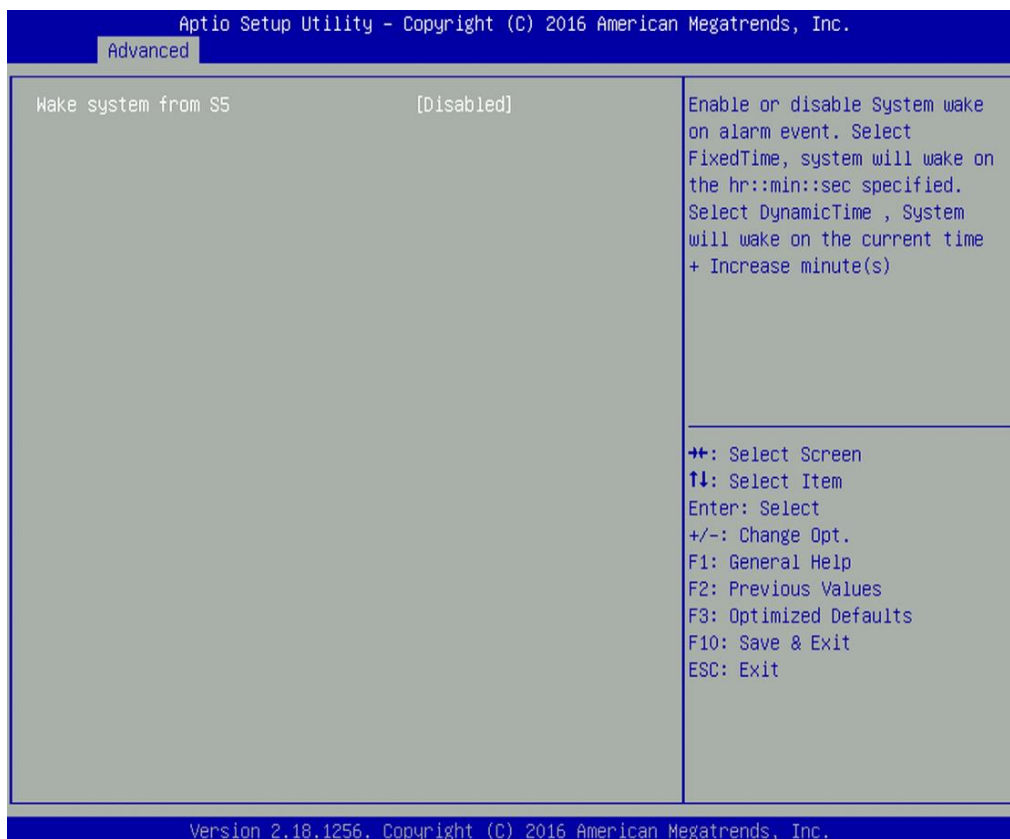

■ Wake system from S5

Enables or disables wake system from S5 (soft-off state).

[Disabled]: Disables wake system from S5.

[Fixed Time]: Sets a fixed time (HH:MM:SS) to wake system from S5.

[Dynamic Time]: Sets a increase minute(s) from current time to wake system from S5.

5.3.7 Serial Port Console Redirection

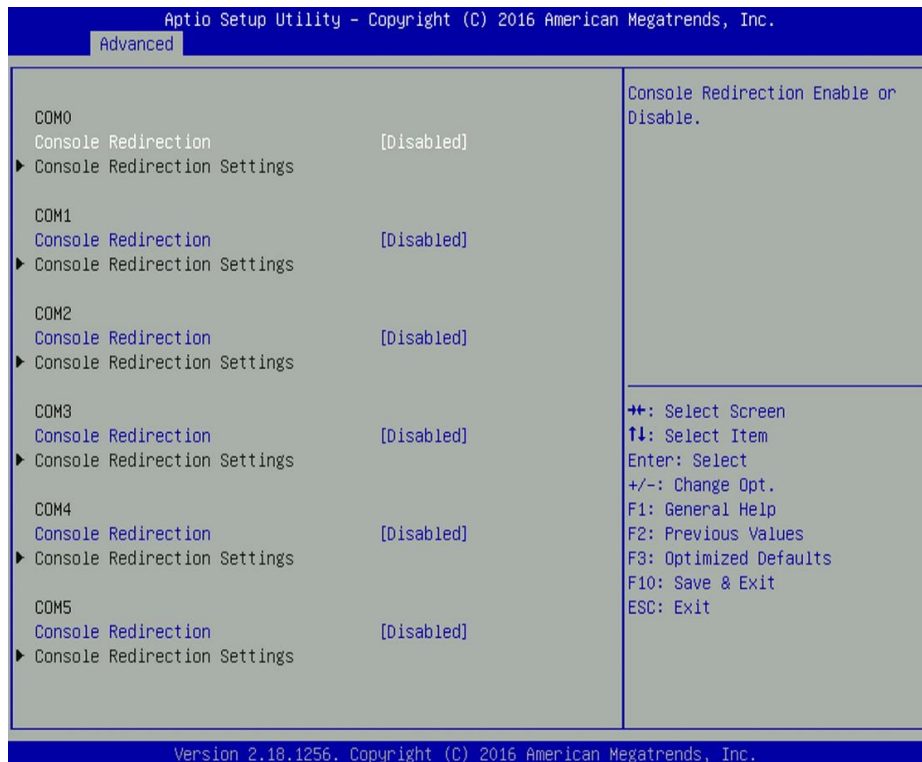

■ Console Redirection

Allow users to enable or disable COM0, COM1, COM2, COM3, COM4, COM5 console redirection function.

- COM0 = Serial Port 1
- COM1 = Serial Port 2
- COM2 = Serial Port 3
- COM3 = Serial Port 4
- COM4 = Serial Port 5
- COM5 = Serial Port 6

5.3.8 CPU Configuration



■ Hyper-threading

Enables or disables for Hyper-Threading Technology.

■ Active Process Cores

Allows you to choose the number of active processor cores.
Configuration options: [All] [1].

■ Intel® Virtualization Technology

Enables or disables Intel® Virtualization Technology, which will allow a platform to run multiple operating systems and applications in independent partitions. With virtualization, one computer system can function as multiple virtual systems..

5.3.9 SATA Configuration

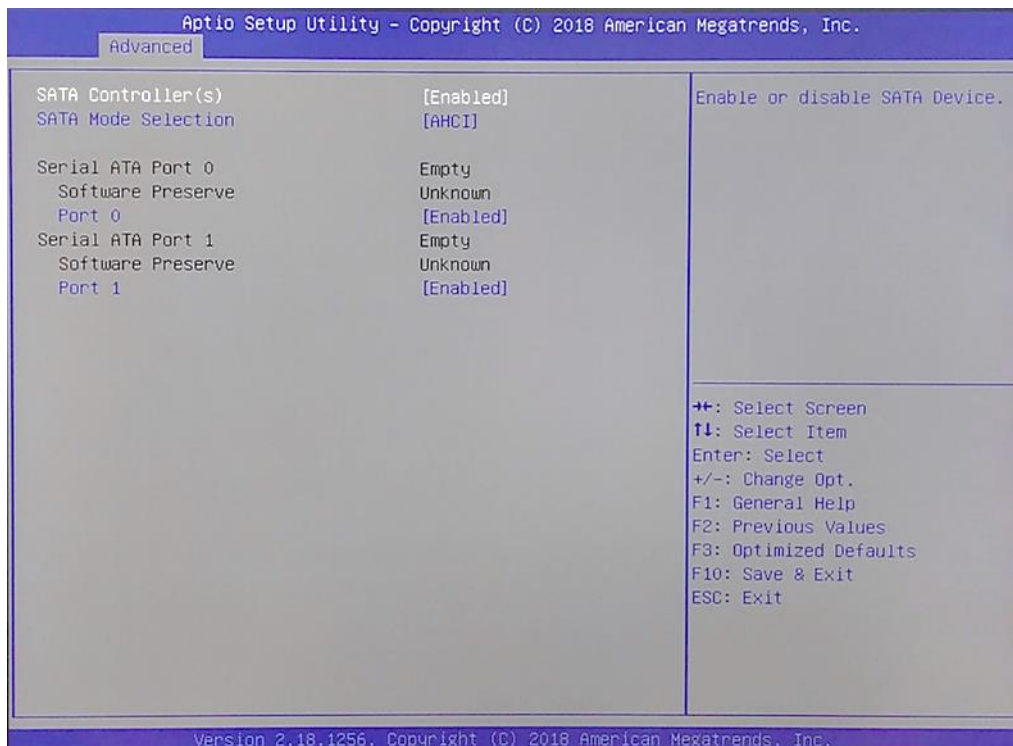

■ SATA Controller(s)

Enables or disables SATA device.

■ SATA Mode Selection

Allows you to select which mode SATA controller will operate in..
Configuration options: [AHCI] [RAID]

■ **Serial ATA Port 0**

Port 0

Enables or disables SATA Port 0.

Hot Plug

Enables or disables Port0 as Hot Pluggable.

■ **Serial ATA Port 1**

Port 1

Enables or disables SATA Port 1.

Hot Plug

Enables or disables Port1 as Hot Pluggable.

5.3.10 CSM Configuration

This option controls legacy/UEFI ROMs priority.

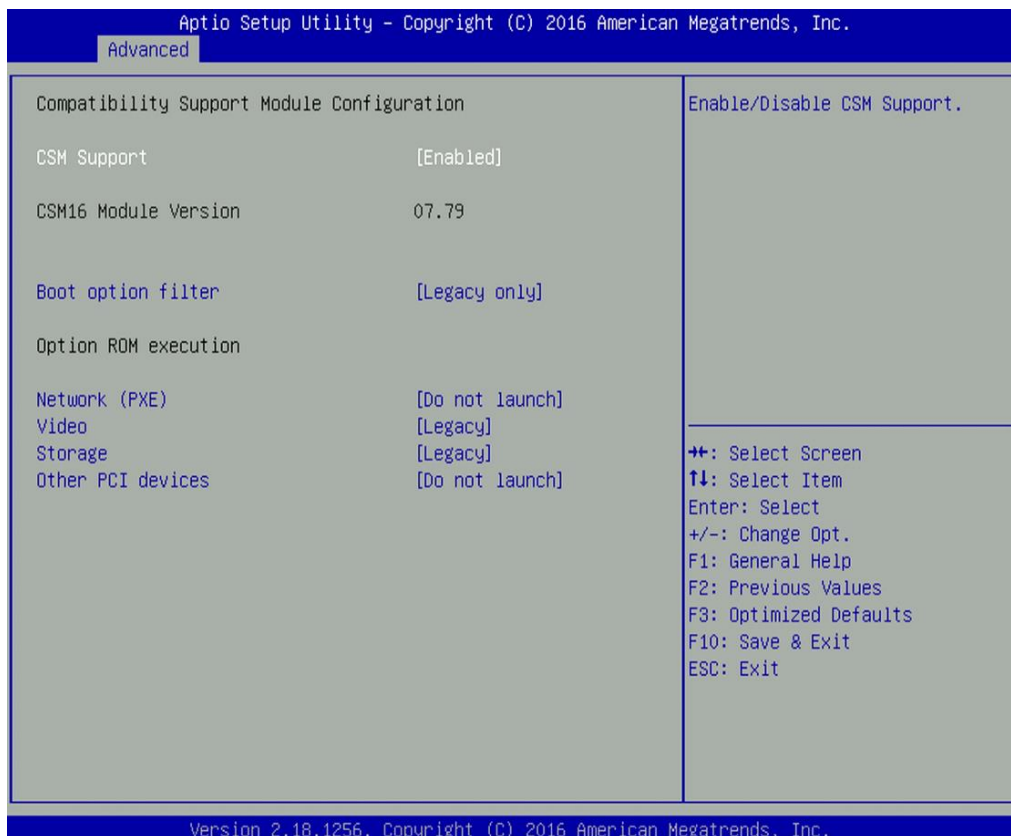

■ **CSM Support**

Enables or disables compatibility support module.

■ **Boot option filter**

Allows you to select which type of operating system to boot.

[UEFI and Legacy]: Allows booting from operating systems that support legacy option ROM or UEFI option ROM.

[Legacy only]: Allows booting from operating systems that only support legacy option ROM.

[UEFI only]: Allows booting from operating systems that only support UEFI option ROM.

■ Network PXE

Controls the execution of UEFI and Legacy PXE (Network Preboot eXecution Environment) option ROM.

[Do not launch]: Disables option ROM execution.

[UEFI]: Enables UEFI option ROM only.

[Legacy]: Enables legacy option ROM only.

■ Video

Controls the execution of UEFI and Legacy Video option ROM.

[Do not launch]: Disables option ROM execution.

[UEFI]: Enables UEFI option ROM only.

[Legacy]: Enables legacy option ROM only.

■ Storage

Controls the execution of UEFI and Legacy Storage option ROM.

[Do not launch]: Disables option ROM execution.

[UEFI]: Enables UEFI option ROM only.

[Legacy]: Enables legacy option ROM only.

■ Other PCI devices

Allows you to determine option ROM execution policy for device other than network, storage, or video.

5.3.11 Asmedia SATA Controller Configuration

This item will display SATA devices information sit on Asmedia SATA controller.



5.3.12 USB Configuration

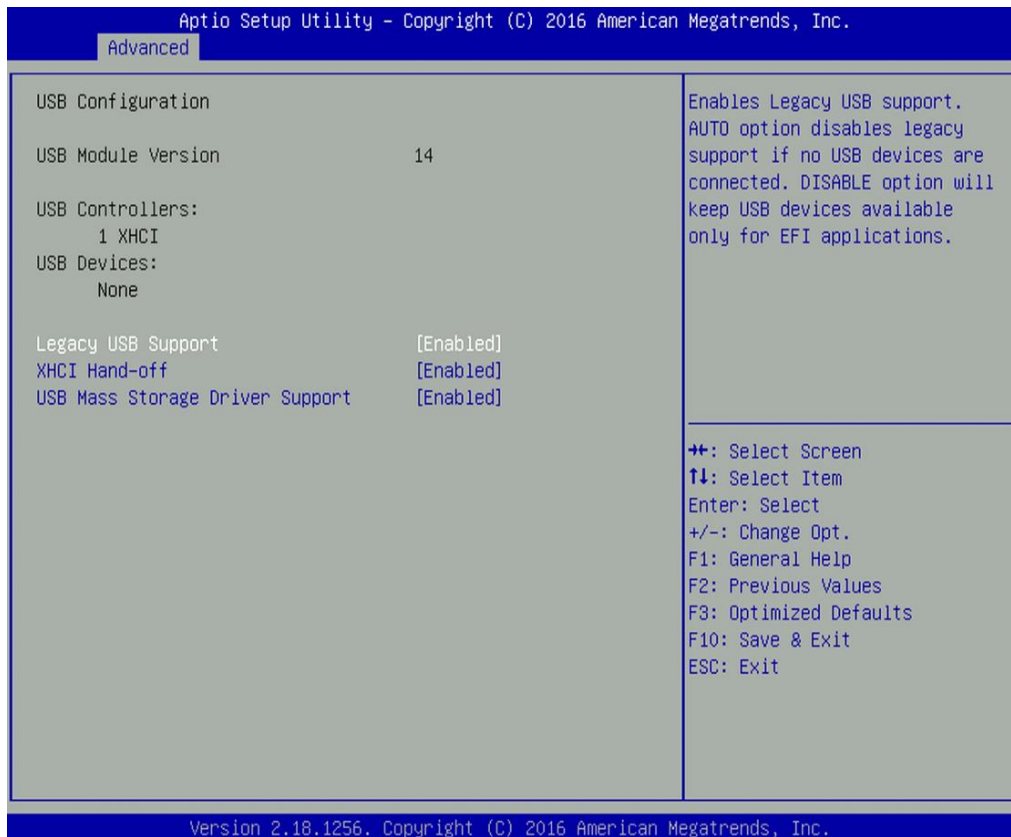

■ Legacy USB Support

This item allows you to enable or disable legacy USB support. When set to [Auto], legacy USB support will be disabled automatically if no USB devices are connected.

■ XHCI Hand-off

Enables or disables XHCI (USB3.0) hand-off function. Use this feature as a workaround for operating systems without XHCI hand-off support.

■ USB Mass Storage Driver Support

Enables or disables USB mass storage driver support.

5.3.13 Intel® I210 Gigabit Network Connection Intel® Ethernet Connection I219-LM

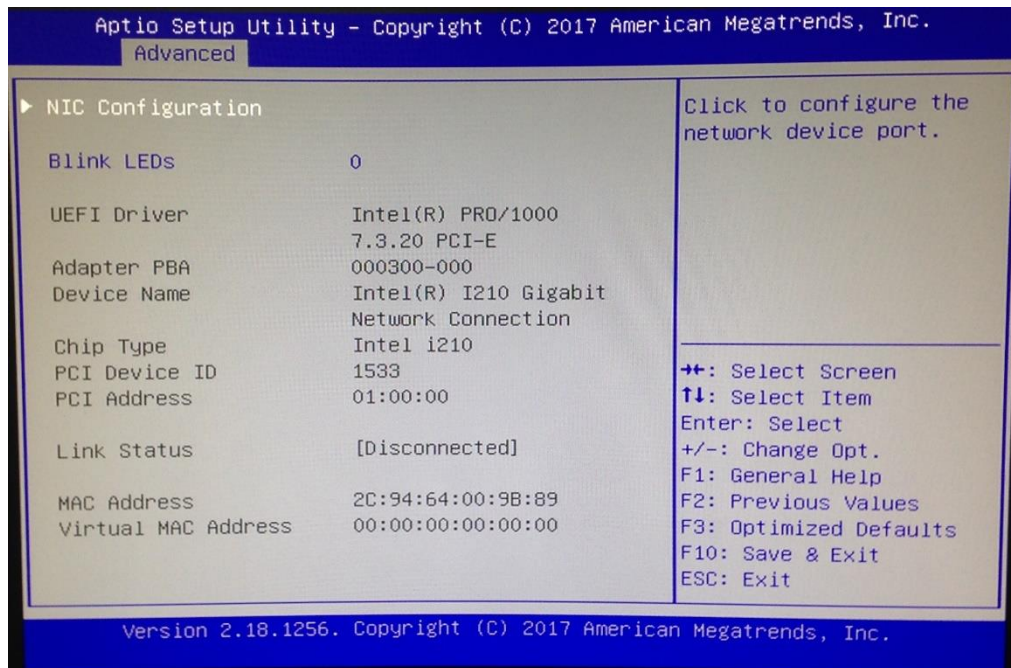

■ NIC Configuration

Link Speed

Change link speed and duplex for current port.

Configuration options: [AutoNeg] [10 Mbps Half] [10 Mbps Full] [100 Mbps Half] [100 Mbps Full]

Wake on LAN

Enables or disables wake the system with a magic packet.

■ Blink LEDs (range 0-15 seconds)

Allows you to change NIC LED blink duration in range of 0-15 seconds.

5.4 Chipset Setup

This section allows you to configure chipset related settings according to user's preference.

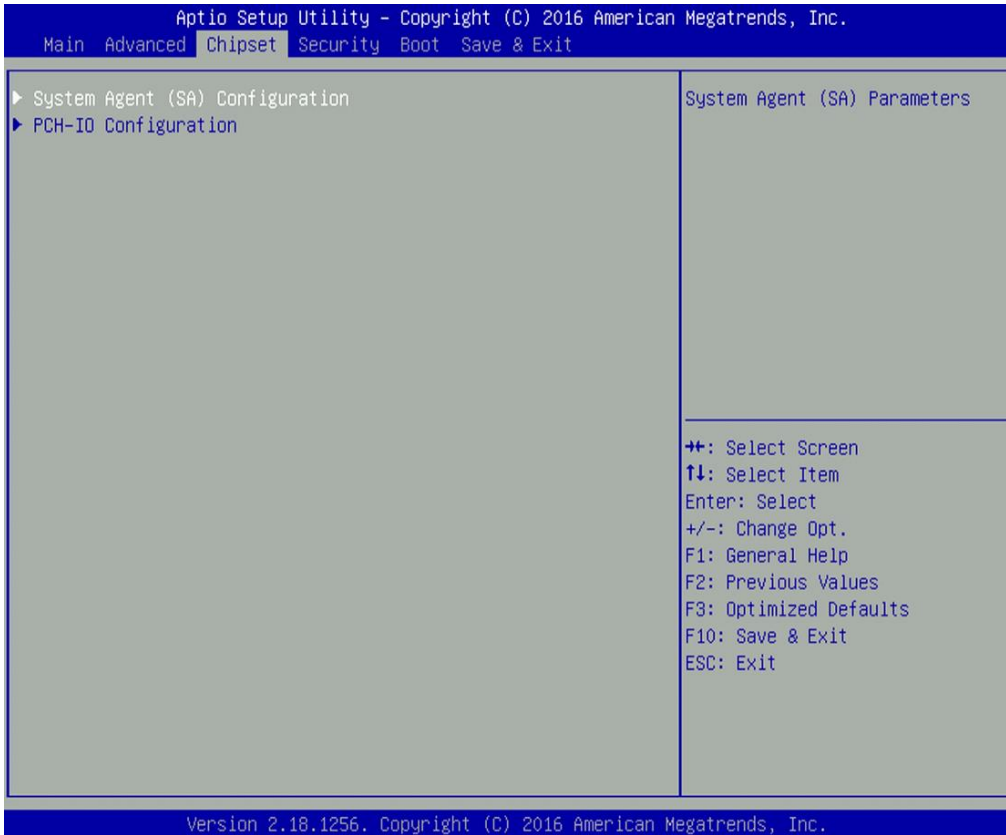

5.4.1 System Agent (SA) Configuration



■ **VT-d**

Enables or disables Intel® Virtualization Technology for Directed I/O (VT-d) capability.

■ **Above 4GB MMIO BIOS assignment**

Enables or disables Above 4GB Memory Mapped IO BIOS assignment. This is disabled automatically when Aperture Size is set to 2048MB.

■ **Memory Configuration**

This item displays detailed memory configuration in the system.

5.4.2 PCH-IO Configuration



■ PCI Express Configuration

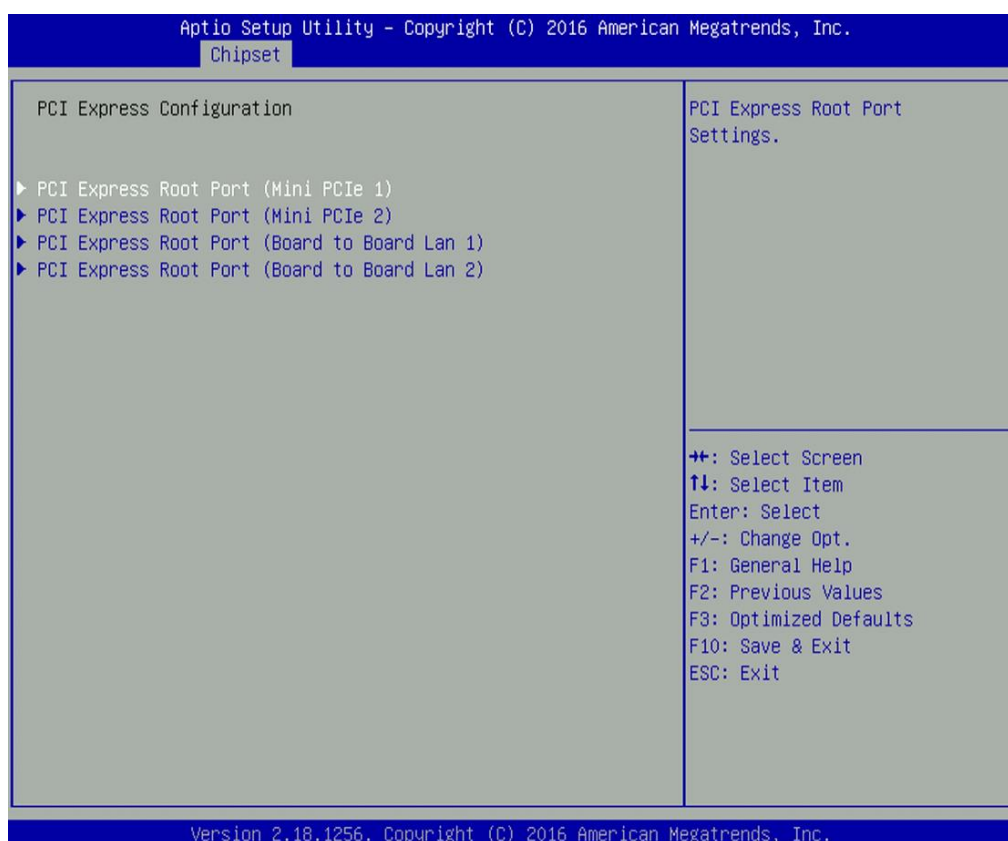

PCI Express Root Port (Mini PCIe 1)

PCI Express Root Port

Enables or disables PCI Express Root Port.

PCIeSpeed

Allows you to select PCI Express port speed.

Configuration options: [Auto] [Gen1] [Gen2] [Gen3].

PCI Express Root Port (Mini PCIe 2)

PCI Express Root Port

Enables or disables PCI Express Root Port.

PCIeSpeed [Auto]

Allows you to select PCI Express port speed.

Configuration options: [Auto] [Gen1] [Gen2] [Gen3].

PCI Express Root Port (Board to Board Lan 1)

PCI Express Root Port

Enables or disables PCI Express Root Port.

PCIeSpeed

Allows you to select PCI Express port speed.

Configuration options: [Auto] [Gen1] [Gen2] [Gen3].

PCI Express Root Port (Board to Board Lan 2)

PCI Express Root Port

Enables or disables PCI Express Root Port.

PCIeSpeed

Allows you to select PCI Express port speed.

Configuration options: [Auto] [Gen1] [Gen2] [Gen3].

■ HD Audio Configuration**□ HD Audio**

Control detection of the HD-Audio device.

Configuration options: [Disabled];[Enabled] [Auto]

■ LAN i219LM Controller

Enables or disables i219LM LAN Controller.

■ LAN i210AT Controller

Enables or disables i210AT LAN Controller.

■ Mini-PCle Slot 1 Function Switch

Allows you to change Mini-PCle Slot 1 as [Mini-PCle] or [mSATA].

■ Mini-PCle Slot 2 Function Switch

Allows you to change Mini-PCle Slot 2 as [Mini-PCle] or [mSATA].

■ Wake on LAN

Enables or disables integrated LAN Wake On LAN function.

■ Power Failure

Allows you to specify which power state system will enter when power is resumed after a power failure (G3 state).

[Always on]: Enters to power on state.

[Always off]: Enters to power off state.

[Keep last state]: Enters to the last power state before a power failure.

5.5 Security Setup

This section allows you to configure BIOS security settings.

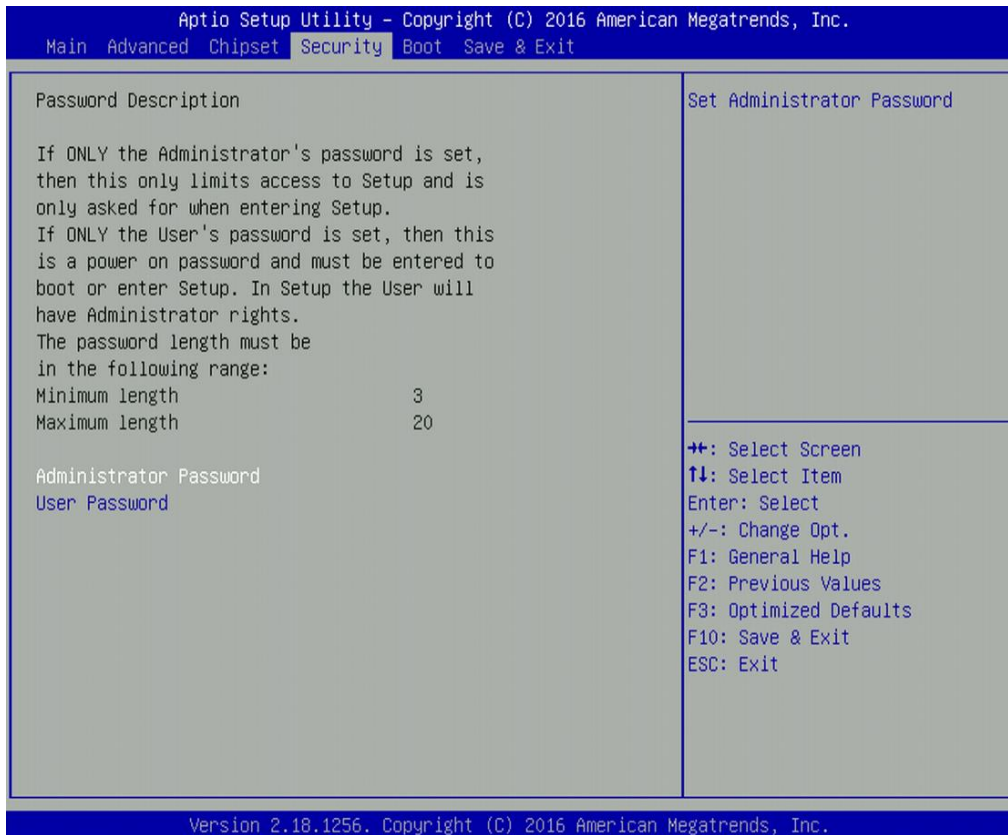

5.5.1 Administrator Password

Allows you to set Administrator Password to control access to the BIOS Setup utility.

5.5.2 User Password

Allows you to set User Password to control access to the system at boot and to the BIOS Setup utility.

5.6 Boot Setup

This section allows you to configure Boot settings.

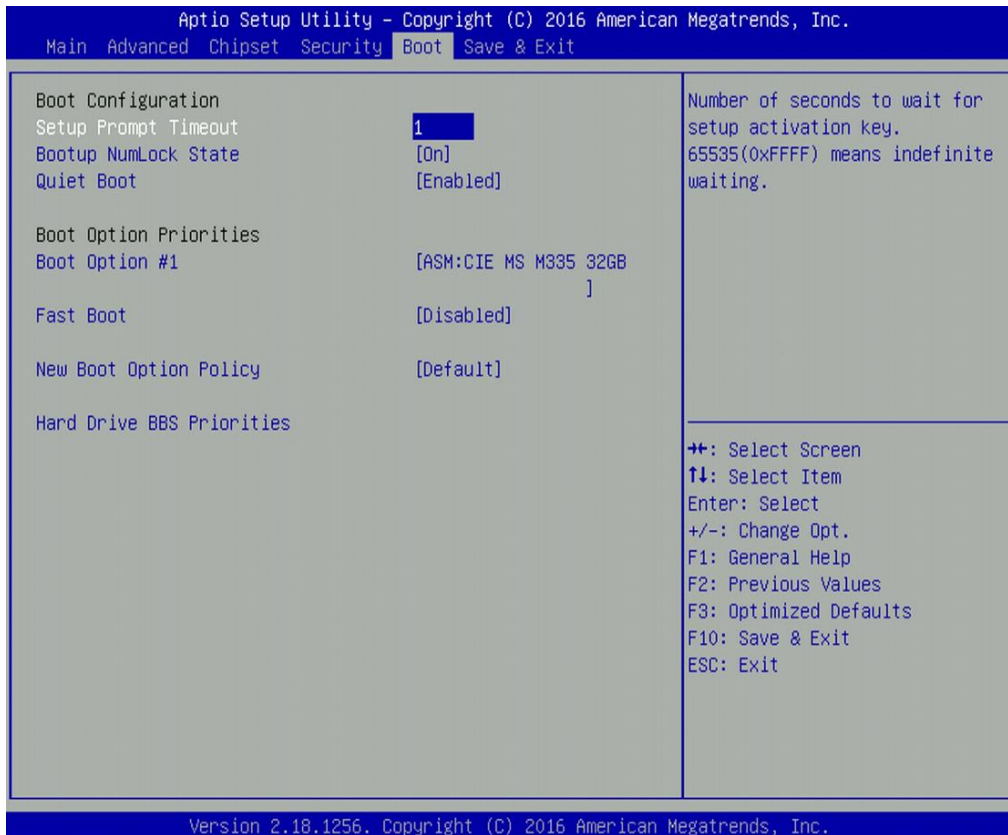

5.6.1 Setup Prompt Timeout

Use this item to set number of seconds (1..65535) to wait for setup activation key.

5.6.2 Bootup NumLock State

Allows you to set NumLock key to <On> or <Off> state when system boots up.

5.6.3 Quiet Boot

Allows you to enable or disable Quiet Boot function.

5.6.4 Fast Boot

Allows you to enable or disable Fast Boot function. If enabled, system boots with initialization of a minimal set of devices required to launch active boot option.

5.6.5 New Boot Option Policy

Allows you to change New Boot Option Policy.

Configuration options: [Default] [Place First] [Place Last].

5.6.6 Hard Drive BBS Priority

Allows you to set the order of the legacy devices in this group.

5.7 Save & Exit

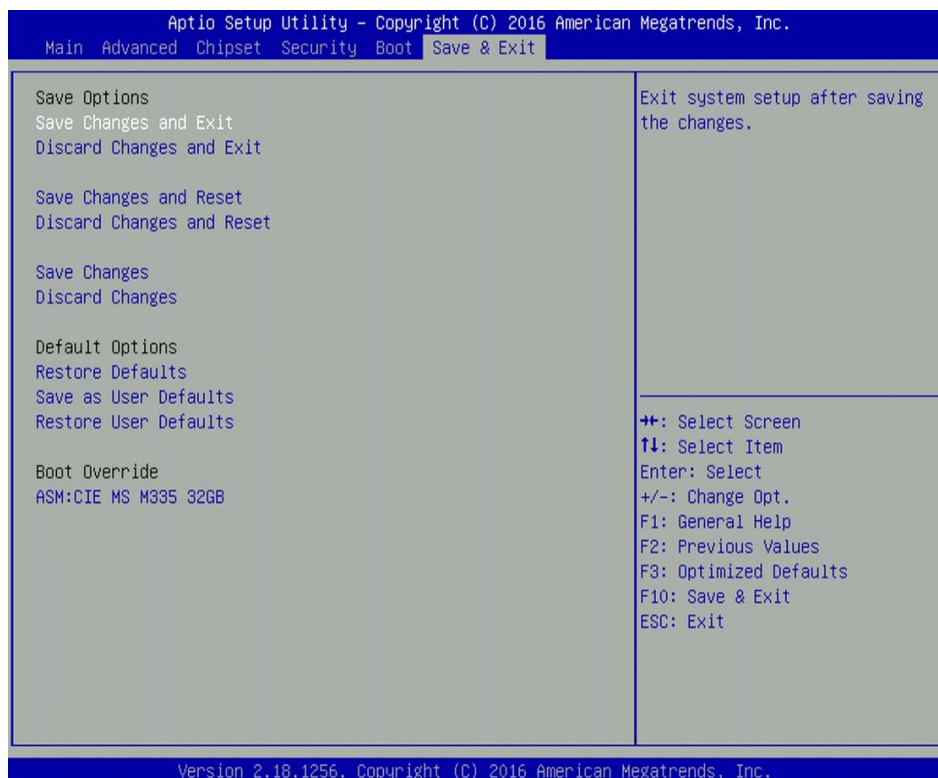

5.7.1 Save Changes and Exit

This item allows you to exit system setup after saving changes.

5.7.2 Discard Changes and Exit

This item allows you to exit system setup without saving changes.

5.7.3 Save Changes and Reset

This item allows you to reset the system after saving changes.

5.7.4 Discard Changes and Reset

This item allows you to reset system setup without saving any changes.

5.7.5 Save Changes

This item allows you to save changes done so far to any of the setup options.

5.7.6 Discard Changes.

This item allows you to discard changes done so far to any of the setup options.

5.7.7 Restore Defaults

This item allows you to restore/ load default values for all the setup options.

5.7.8 Save as User Defaults

This item allows you to save the changes done so far as user defaults.

5.7.9 Restore User Defaults

This item allows you to restore the user defaults to all the setup options.



Chapter 6

Product Application

(For DIO only)

This chapter describes the DIO applications .

6.1 Digital I/O (DIO) Application

This section describes DIO application of the product. The content and application development are better understood and implemented by well experienced professionals or developers.

6.1.1 Digital I/O Programming Guide

6.1.1.1 Pins for Digital I/O

Item	Standard
GPIO74 (Pin107)	DI
GPIO75 (Pin108)	
GPIO76 (Pin109)	
GPIO77 (Pin110)	
GPIO80 (Pin111)	DO
GPIO81 (Pin112)	
GPIO82 (Pin113)	
GPIO83 (Pin114)	

6.1.1.2 Programming Guide

To program the F81866A configuration registers, the following configuration procedures must be followed in sequence:

- (1) Enter the Extended Function Mode
- (2) Configure the configuration registers
- (3) Exit the Extended Function Mode

The configuration register is used to control the behavior of the corresponding devices. To configure the register, using the index port to select the index and then writing data port to alter the parameters. The default index port and data port are 0x4E and 0x4F, respectively. To enable configuration, the entry key 0x87 must be written to the index port. To disable configuration, write exit entry key 0xAA to the index port. Following is an example to enable configuration and disable configuration by using debug.

- ```
-o 4e 87
-o 4e 87 (enable configuration)
-o 4e aa (disable configuration)
```

### 6.1.1.3 Relative Registers

To program the F81866A configuration registers, the following configuration procedures.

**Logic Device Number Register (LDN) — Index 07h**

| Bit | Name | R/W | Reset   | Default | Description                                                                                                                                                                                                                                                                                                                                                                                                                                                                                                                                                                                                                                                                                                                                                   |
|-----|------|-----|---------|---------|---------------------------------------------------------------------------------------------------------------------------------------------------------------------------------------------------------------------------------------------------------------------------------------------------------------------------------------------------------------------------------------------------------------------------------------------------------------------------------------------------------------------------------------------------------------------------------------------------------------------------------------------------------------------------------------------------------------------------------------------------------------|
| 7-0 | LDN  | R/W | LRESET# | 00h     | 00h: Select FDC device configuration registers.<br>03h: Select Parallel Port device configuration registers.<br>04h: Select Hardware Monitor device configuration registers.<br>05h: Select KBC device configuration registers.<br>06h: Select GPIO device configuration registers.<br>07h: Select WDT device configuration registers.<br>0Ah: Select PME, ACPI and ERP device configuration registers.<br>10h: Select UART1 device configuration registers.<br>11h: Select UART2 device configuration registers.<br>12h: Select UART3 device configuration registers.<br>13h: Select UART4 device configuration registers.<br>14h: Select UART5 device configuration registers.<br>15h: Select UART6 device configuration registers.<br>Otherwise: Reserved. |

**7.7.11.1GPIO7 Output Enable Register — Index 80h**

| Bit | Name      | R/W | Reset   | Default | Description                                                 |
|-----|-----------|-----|---------|---------|-------------------------------------------------------------|
| 7   | GPIO77_OE | R/W | LRESET# | 0       | 0: GPIO77 is in input mode.<br>1: GPIO77 is in output mode. |
| 6   | GPIO76_OE | R/W | LRESET# | 0       | 0: GPIO76 is in input mode.<br>1: GPIO75 is in output mode. |
| 5   | GPIO75_OE | R/W | LRESET# | 0       | 0: GPIO75 is in input mode.<br>1: GPIO75 is in output mode. |
| 4   | GPIO74_OE | R/W | LRESET# | 0       | 0: GPIO74 is in input mode.<br>1: GPIO74 is in output mode. |

**7.7.11.3GPIO7 Pin Status Register — Index 82h (This byte could be also read by base address + 3)**

| Bit | Name      | R/W | Reset | Default | Description                     |
|-----|-----------|-----|-------|---------|---------------------------------|
| 7   | GPIO77_IN | R   | -     | -       | The pin status of GPIO77/STB#.  |
| 6   | GPIO76_IN | R   | -     | -       | The pin status of GPIO76/AFD#.  |
| 5   | GPIO75_IN | R   | -     | -       | The pin status of GPIO75/ERR#.  |
| 4   | GPIO74_IN | R   | -     | -       | The pin status of GPIO74/INIT#. |

**7.7.12.1GPIO8 Output Enable Register — Index 88h**

|   |           |     |         |   |                                                             |
|---|-----------|-----|---------|---|-------------------------------------------------------------|
| 3 | GPIO83_OE | R/W | LRESET# | 1 | 0: GPIO83 is in input mode.<br>1: GPIO83 is in output mode. |
| 2 | GPIO82_OE | R/W | LRESET# | 1 | 0: GPIO82 is in input mode.<br>1: GPIO82 is in output mode. |
| 1 | GPIO81_OE | R/W | LRESET# | 1 | 0: GPIO81 is in input mode.<br>1: GPIO81 is in output mode. |
| 0 | GPIO80_OE | R/W | LRESET# | 1 | 0: GPIO80 is in input mode.<br>1: GPIO80 is in output mode. |

7.7.12.2 GPIO8 Output Data Register — Index 89h (This byte could be also written by base address + 2)

|   |            |     |         |   |                                                                                      |
|---|------------|-----|---------|---|--------------------------------------------------------------------------------------|
| 3 | GPIO83_VAL | R/W | LRESET# | 1 | 0: GPIO83 outputs 0 when in output mode.<br>1: GPIO83 outputs 1 when in output mode. |
| 2 | GPIO82_VAL | R/W | LRESET# | 1 | 0: GPIO82 outputs 0 when in output mode.<br>1: GPIO82 outputs 1 when in output mode. |
| 1 | GPIO81_VAL | R/W | LRESET# | 1 | 0: GPIO81 outputs 0 when in output mode.<br>1: GPIO81 outputs 1 when in output mode. |
| 0 | GPIO80_VAL | R/W | LRESET# | 1 | 0: GPIO80 outputs 0 when in output mode.<br>1: GPIO80 outputs 1 when in output mode. |

### 6.1.1.4 Sample Code in C Language

#### 6.1.1.4.1 Control of GP74 to GP77 (DI1 ~ DI4)

```
#define AddrPort 0x4E
```

```
#define DataPort 0x4F
```

<Enter the Extended Function Mode>

```
WriteByte(AddrPort, 0x87)
```

```
WriteByte(AddrPort, 0x87) //Must write twice to entering Extended mode
```

<Select Logic Device>

```
WriteByte(AddrPort, 0x07)
```

```
WriteByte(dataPort, 0x06)
```

```
//Select logic device 06h
```

<Input Mode Selection> //Set GP74 to GP77 input Mode

```
WriteByte(AddrPort, 0x80) // Select configuration register 80h
```

```
WriteByte(DataPort, 0x0X)
```

```
//Set (bit 4~7) = 0 to select GP 74~77 as Input mode.
```

<input Value>

```
WriteByte(AddrPort, 0x82) // Select configuration register 82h
```

```
ReadByte(DataPort, Value) // Read bit 4~7(0xFx)= GP74 ~77 as High.
```

<Leave the Extended Function Mode>

```
WriteByte(AddrPort, 0xAA)
```



#### 6.1.1.4.2 Control of GP80 to GP83 (DO1 ~ DO4)

```
#define AddrPort 0x4E
#define DataPort 0x4F
```

<Enter the Extended Function Mode>

```
WriteByte(AddrPort, 0x87)
WriteByte(AddrPort, 0x87) //Must write twice to entering Extended mode
```

<Select Logic Device>

```
WriteByte(AddrPort, 0x07)
WriteByte(DataPort, 0x06)
// Select logic device 06h
```

<Output Mode Selection> //Set GP80 to GP83 output Mode

```
WriteByte(AddrPort, 0x88) // Select configuration register 88h
WriteByte(DataPort, (0xFF))
//Set (bit 0~3) = 1 to select GP 80 ~83 as Output mode.
```

<Output Value>

```
WriteByte(AddrPort, 0x89) // Select configuration register 89h
WriteByte(DataPort, Value) // Set bit 0~3=(0/1) to output GP 80~83 as Low or High
```

<Leave the Extended Function Mode>

```
WriteByte(AddrPort, 0xAA)
```

#### 6.1.1.5 Change base address

<Enter the Extended Function Mode>

```
WriteByte(AddrPort, 0x87)
WriteByte(AddrPort, 0x87) //Must write twice to entering Extended mode
```

<Select Logic Device>

```
WriteByte(AddrPort, 0x07)
WriteByte(dataPort, 0x06)
//Select logic device 06h
```

```
WriteByte(AddrPort, 0x60) // Select configuration register 60h (High Byte address)
```

```
WriteByte(DataPort, (0x0A))
```

```
WriteByte(AddrPort, 0x61) // Select configuration register 61h (Low Byte address)
```

```
WriteByte(DataPort, (0x00))
```

<Leave the Extended Function Mode>

```
WriteByte(AddrPort, 0xAA)
```

Cincoze default DIO Port base address is set to 0x0A00h

### 6.1.1.6 DATA Bit Table (DIO)

|   |   |   |   |   |   |   |   |       |
|---|---|---|---|---|---|---|---|-------|
| 7 | 6 | 5 | 4 | 3 | 2 | 1 | 0 | bit   |
| 0 | 0 | 0 | 1 | - | - | - | - | value |
| 1 |   |   |   | X |   |   |   | /h    |

**= DI1**  
**(Base address +3) (0xA03)**

|   |   |   |   |   |   |   |   |       |
|---|---|---|---|---|---|---|---|-------|
| 7 | 6 | 5 | 4 | 3 | 2 | 1 | 0 | bit   |
| 0 | 0 | 1 | 0 | - | - | - | - | value |
| 2 |   |   |   | X |   |   |   | /h    |

**= DI2**  
**(Base address +3) (0xA03)**

|   |   |   |   |   |   |   |   |       |
|---|---|---|---|---|---|---|---|-------|
| 7 | 6 | 5 | 4 | 3 | 2 | 1 | 0 | bit   |
| 0 | 1 | 0 | 0 | - | - | - | - | value |
| 4 |   |   |   | X |   |   |   | /h    |

**= DI3**  
**(Base address +3) (0xA03)**

|   |   |   |   |   |   |   |   |       |
|---|---|---|---|---|---|---|---|-------|
| 7 | 6 | 5 | 4 | 3 | 2 | 1 | 0 | bit   |
| 1 | 0 | 0 | 0 | - | - | - | - | value |
| 8 |   |   |   | X |   |   |   | /h    |

**= DI4**  
**(Base address +3) (0xA03)**

|   |   |   |   |   |   |   |   |       |
|---|---|---|---|---|---|---|---|-------|
| 7 | 6 | 5 | 4 | 3 | 2 | 1 | 0 | bit   |
| - | - | - | - | 0 | 0 | 0 | 1 | value |
| X |   |   |   | 1 |   |   |   | /h    |

**= DO1**  
**(Base address +2) (0xA02)**

|   |   |   |   |   |   |   |   |       |
|---|---|---|---|---|---|---|---|-------|
| 7 | 6 | 5 | 4 | 3 | 2 | 1 | 0 | bit   |
| - | - | - | - | 0 | 0 | 1 | 0 | value |
| X |   |   |   | 2 |   |   |   | /h    |

**= DO2**  
**(Base address +2) (0xA02)**

|   |   |   |   |   |   |   |   |       |
|---|---|---|---|---|---|---|---|-------|
| 7 | 6 | 5 | 4 | 3 | 2 | 1 | 0 | bit   |
| - | - | - | - | 0 | 1 | 0 | 0 | value |
| X |   |   |   | 4 |   |   |   | /h    |

**= DO3**  
**(Base address +2) (0xA02)**

|   |   |   |   |   |   |   |   |       |
|---|---|---|---|---|---|---|---|-------|
| 7 | 6 | 5 | 4 | 3 | 2 | 1 | 0 | bit   |
| - | - | - | - | 1 | 0 | 0 | 0 | value |
| X |   |   |   | 8 |   |   |   | /h    |

**= DO4**  
**(Base address +2) (0xA02)**

### 6.1.1.7 DIO I/O Port Address (Default Address 0xA00)

| DI4   | DI3 | DI2 | DI1 | DO4   | DO3 | DO2 | DO1 | Pin Definition   |
|-------|-----|-----|-----|-------|-----|-----|-----|------------------|
| 7     | 6   | 5   | 4   | 3     | 2   | 1   | 0   | Data Bits        |
| DI    |     |     |     | DO    |     |     |     | DIO              |
| 0xA03 |     |     |     | 0xA02 |     |     |     | I/O Port address |

## 6.2 Digital I/O (DIO) Hardware Specification

- XCOM+ / 2XCOM+ : Isolated power in V+
- XCOM- / 2XCOM- : Isolated power in V-
- Isolated power in DC voltage : 9~30V
- 8x Digital Input (Source Type)
- Input Signal Voltage Level
  - Signal Logic 0 : XCOM+ = 9V,  $\text{Signal Low} - \underline{V-} < 1\text{V}$   
XCOM+ > 9V,  $\underline{V+} - \text{Signal Low} > 8\text{V}$
  - Signal Logic 1 : >  $\underline{\text{XCOM+}} - \underline{3\text{V}}$
- Input Driving Sink Current :
  - Minimal : 1 mA
  - Normal : 5 mA
- 8x Digital Output (Open Drain)
  - DO Signal have to pull up resistor to XCOM+ for external device, the resistance will affect the pull up current
  - Signal High Level : Pull up resistor to XCOM+
  - Signal Low Level : = XCOM-
  - Sink Current: 1A (Max)

# 6.2.1 DIO Connector Definitions

## DIO1: Digital Input / Output Connector

Connector Type: Terminal Block 2X5 10-pin, 3.5mm pitch

| Pin | Definition | Pin | Definition |
|-----|------------|-----|------------|
| 1   | DI1        | 2   | DO1        |
| 3   | DI2        | 4   | DO2        |
| 5   | DI3        | 6   | DO3        |
| 7   | DI4        | 8   | DO4        |
| 9   | DC INPUT   | 10  | GND        |

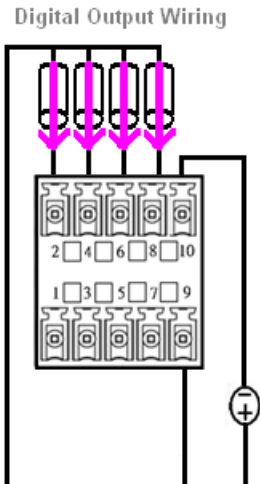
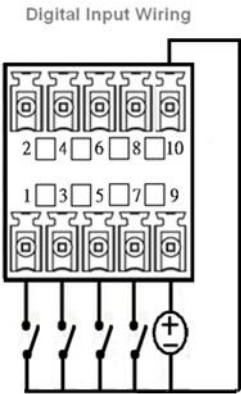
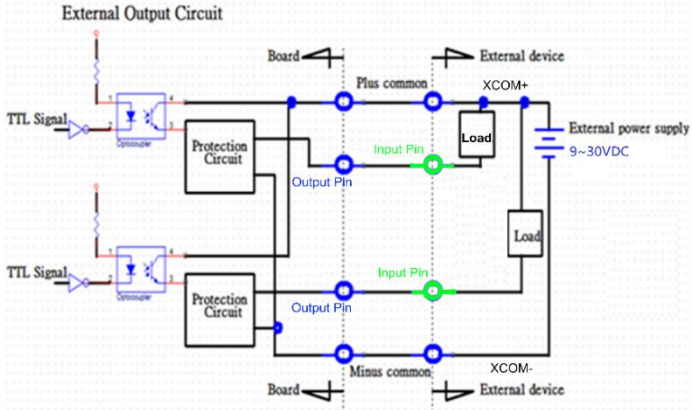
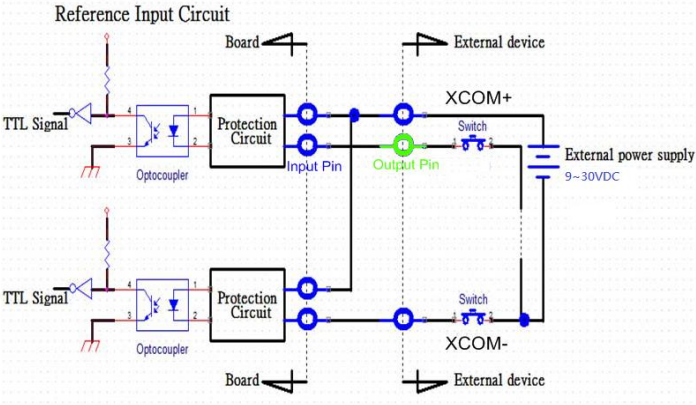
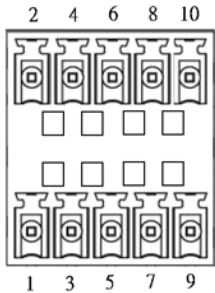



[www.cincoze.com](http://www.cincoze.com)

© 2014 Cincoze Co., Ltd. All rights reserved.

The Cincoze logo is a registered trademark of Cincoze Co., Ltd.

All other logos appearing in this catalog are the intellectual property of the respective company, product, or organization associated with the logo.

All product specifications and information are subject to change without notice.